

# 2019

## CATALOG

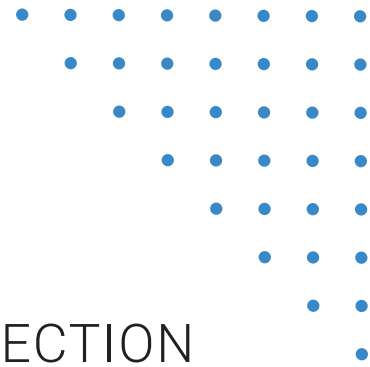

**INFAB**  
TRANSPARENCY IN RADIATION PROTECTION



# PEACE OF MIND IN RADIATION PROTECTION

Infab Corporation designs and builds the world's lightest weight, most comfortable and technologically advanced radiation attenuation products with the highest protection levels of any manufacturer.

About Infab.....	3
Core Material.....	5
Aprons.....	8
Revolution.....	8
Colors.....	19
Sizing.....	22
Classic.....	23
Dental.....	33
Colors.....	35
Sizing.....	40
Smart Track.....	41
Accessories.....	43
Cleaners.....	45
Cassette Covers.....	52
Glasses.....	55
Gloves.....	70
Scatter Armor.....	74
Barriers.....	76
Apron Racks.....	87
Curtains.....	98
Patient.....	104
Certification & Testing.....	107
Terms.....	116



# WELCOME TO INFAB

Infab enables health care providers and patients to apply and benefit from the diagnostic capabilities of imaging technology with the peace of mind that comes from knowing they are protected by the best engineered garments, eye gear and protective barriers on the planet.

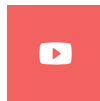

**View the Infab Video Channel**

[YouTube.com/Infabcorp](https://www.youtube.com/Infabcorp)



**Connect with us on Facebook**

[Facebook.com/Infabcorp](https://www.facebook.com/Infabcorp)



**Connect with us on Twitter**

[Twitter.com/Infabcorp](https://www.twitter.com/Infabcorp)



**Connect with us on Instagram**

[Instagram.com/Infabcorp](https://www.instagram.com/Infabcorp)



**Connect with us on LinkedIn**

[Linkedin.com/company/infab-corporation](https://www.linkedin.com/company/infab-corporation)



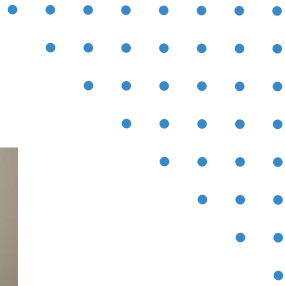

Don Cusick  
CEO



Brittany Lepley  
President



Tom Fink  
VP Operations



Justine Peterson  
VP Sales, International



Tyler Cusick  
VP of Marketing

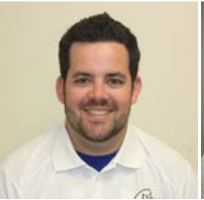

Billy Morgan  
VP of North American  
Sales



Eddie Godinez  
South American Sales



Trevor James  
Customer Relations  
Manager



Yolanda Welsh  
Customer Relations



Brittany Slater  
Customer Relations



Jaime Breece  
Customer Relations



Brian Malkin  
VP of Business Development  
SmartTrack Director



Crystal Lepley  
Product Education  
Specialist, New York Rep



Tom Morris  
East Coast Representative



James Tullie  
National Representative



Cindy McLaughlin  
New England Region  
Representative



Meghan Smith  
New England  
Representative



Vincent Ricca  
PA/OH Representative



Justin Dube  
Texas Representative



Mark Binder  
Southeast Representative



Caitlin Dill  
Western Region  
Representative

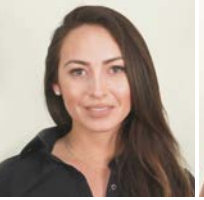

Lauren Schwartz  
West Coast  
Representative



Iryna Zhukava  
Pacific Northwest  
Representative



Pam Barnett  
Four Corners Representative  
(AZ, UT, CO & NM)



Nick Busch  
Mid-South Region  
Representative



Alec Swain  
Michigan Representative



Shenae DeWeese  
Mid-Atlantic  
Representative



Thomas Smith  
Mid-Atlantic  
Representative



Danielle Daley  
Midwest Representative

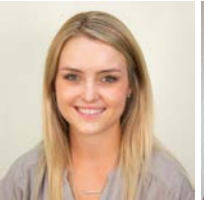

Natalie Dietrich  
Midwest Representative



Marianne Crowley  
Controller /  
HR Manager



Amanda DeRaad  
Account Administrator



Sally Garcia  
Purchasing



Baron Miller  
Graphic Designer



Infab Production Team

# TRANSPARENCY IN RADIATION PROTECTION

REAL TESTING. REAL RESULTS. REAL WEIGHTS. REAL PROTECTION.

For over 30 years Infab has been a leader in providing our customers with new and innovative products to protect against harmful radiation. In 2019 we embark on our next industry changing path, Transparency in Radiation Protection. We believe our customers have the right to be educated about exactly what is in their radiation protection aprons. We have adopted a simple three core material line, KIARMOR Lead Free, KIARMOR Low Lead and Lightweight Lead. A simple glance through our core material section will allow customers to easily select the core material best for them. Every core material option provides complete attenuation between 50 and 150 kVp and includes an example of the apron weight.

Infab has put countless hours into researching and finding the best materials to keep customers safe, which is why we urge you to always ask for testing results as NO APRON lighter than an Infab KIARMOR apron can pass all international protection standards.



For the whole story, visit: [Infabcorp.com/theKIARMORstory](https://Infabcorp.com/theKIARMORstory)





CE 0338

ISO 13485:2016



# RADIATION PROTECTION CORE MATERIAL

	Materials	Lead Equivalency	Attenuation						Core Weight Lb/Sq. Ft. (of core in apron)	Core Weight KG/m <sup>2</sup> (area density)	Front Protection Male Medium Apron Weight 303M-M
			50 kVp	70 kVp	90 kVp	110 kVp	120 kVp	150kVp			
 <p>KIARMOR Lead-Free is the lightest weight protection offered. It is the only lead-free material that passes all 3 universally recognized testing procedures: ASTM F3094-14, IEC 61331-1:2014, DIN 6857-1</p>	Antimony, Bismuth One Homogeneous Layer	.25mm LE	98.7%	96.1%	92.0%	87.8%	85.8%	80.1%	0.548	2.55	3.85 Lbs.
		.35mm LE	99.6%	98.0%	95.3%	92.7%	91.5%	88.1%	0.768	3.56	5.0 Lbs.
		.5mm LE	99.9%	99.4%	97.8%	96.3%	95.5%	93.0%	1.09	5.09	6.95 Lbs.
 <p>KIARMOR Low-Lead passes all 3 universally recognized testing procedures: ASTM F3094-14, IEC 61331-1:2014, DIN 6857-1</p>	Antimony, Lead One Homogeneous Layer	.25mm LE	98.9%	96.5%	92.5%	88.5%	86.5%	80.9%	0.563	2.61	4.0 Lbs.
		.35mm LE	99.6%	98.1%	95.6%	93.1%	91.9%	88.4%	0.788	3.66	5.25 Lbs.
		.5mm LE	99.9%	99.4%	98.0%	96.5%	95.7%	93.3%	1.12	5.23	7.25 Lbs.
 <p>Our Lightweight Lead core material passes all 3 universally recognized testing procedures: ASTM F3094-14, IEC 61331-1:2014, DIN 6857-1</p>	Lightweight Lead	.25mm LE	98.8%	95.1%	90.7%	87.5%	86.2%	82.7%	0.636	3.04	4.35 Lbs
		.35mm LE	99.7%	97.6%	94.5%	92.3%	91.3%	88.6%	0.96	4.26	6.15 Lbs
		.5mm LE	99.9%	99.1%	97.4%	96.1%	95.5%	93.0%	1.26	6.08	8.0 Lbs



## KIARMOR BI-LAYER MATERIAL

The World's Most Advanced Certified Radiation Protection Core Material.

### Tested & Certified Against 50 kVp to 150 kVp

KIARMOR Bi-Layer is tested and certified for attenuation and lead equivalence by the National Physical Laboratory (NPL) against a full range of radiation qualities **50 kVp to 150 kVp** using the broad beam geometry method.

### 2 Individual layers within 1 Homogenous Material

KIARMOR takes advantage of the physics associated with using individual layers of specific materials to provide maximum attenuation by eliminating the effects of fluorescence.

### Certified to DIN, IEC & ASTM Standards

KIARMOR is the only lead-free material that passes all three universally recognized testing procedures: ASTM F3094-14, IEC 61331-1:2014, DIN 6857-1.



DIN 6857-1



IEC 61331-1:2014



ASTM F3094-14



KIARMOR Lead-Free is the lightest weight protection offered. It is the only lead-free material that passes all 3 universally recognized testing procedures: ASTM F3094-14, IEC 61331-1:2014, DIN 6857-1

Sb	Antimony	51 (Low atomic weight element)
Bi	Bismuth	83 (High atomic weight element)



KIARMOR Low-Lead passes all 3 universally recognized testing procedures: ASTM F3094-14, IEC 61331-1:2014, DIN 6857-1

Sb	Antimony	51 (Low atomic weight element)
Pb	Lead	82 (High atomic weight element)

# REVOLUTION

## APRONS

Revolution aprons consist of the highest quality materials that are combined with industry leading protection to create an industry changing design.

## COMFORT

Designed for the best weight distribution and to fit a wide variety of body types. Ergonomically correct fit designed by experts so it fits as well as it protects.

## PROTECTION

Partial overlap designs offer full protection in each panel making these the most protective aprons available.

## STYLE

Revolution Premium aprons offer Revolution fabric and color-blocked design.

## COOL WEAR

Moisture-wicking material that is included on the inside of all Revolution Premium aprons.

## PERSONALIZATION

- Monograms
- Logo





# REVOLUTION Core Material Configurations

## Partial Overlap

REVOLUTION vests and full wrap aprons do not require a full overlap to achieve the stated protection level.

### REVOLUTION 103, B103, L103, BL103

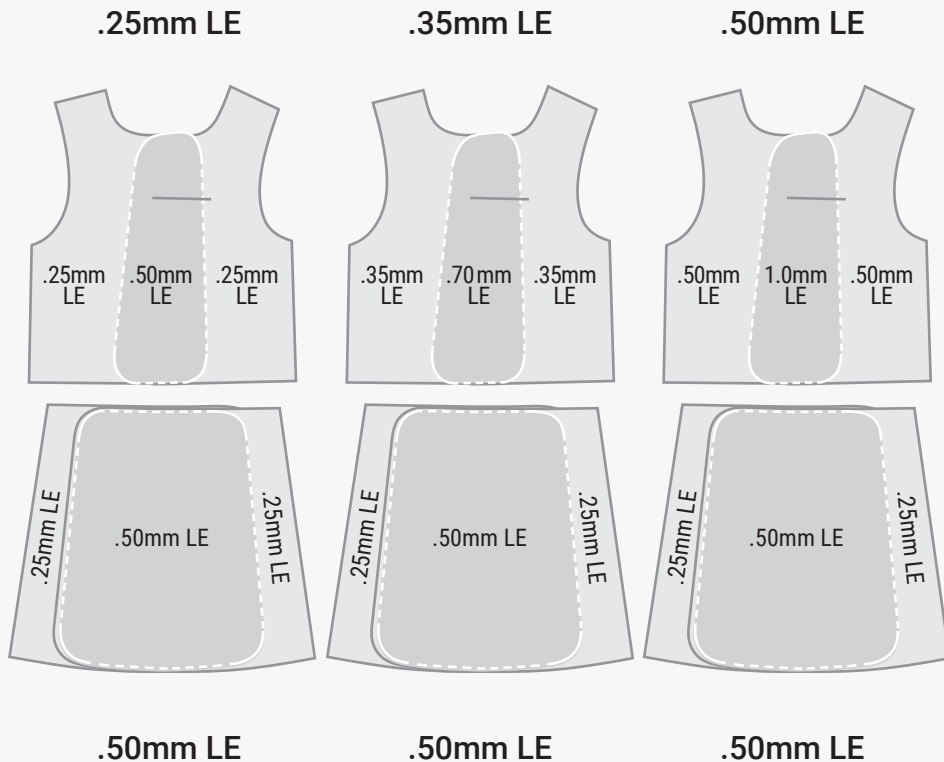

### REVOLUTION 203, B203

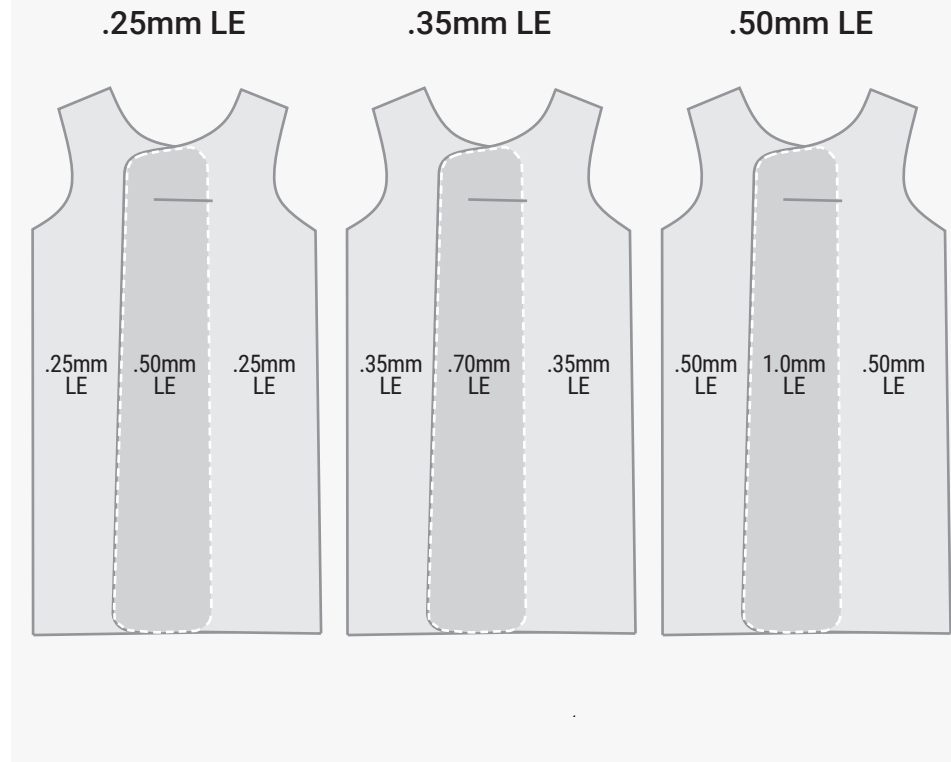

All back panels are .25mm LE. All skirts are .50mm LE at overlap.

## REVOLUTION Core Material Configurations *Continued*



### No Overlap

**REVOLUTION**  
303, B303, 403, B403, 503, B503, 603, B603

.25mm LE

.35mm LE

.50mm LE

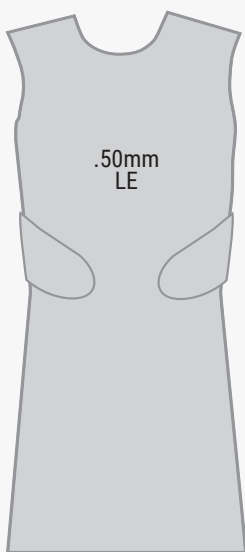
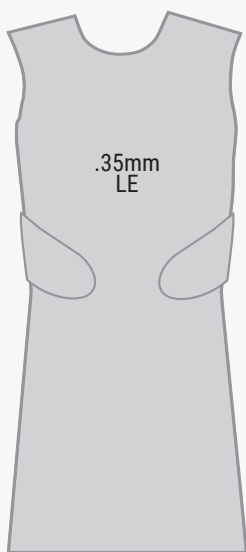
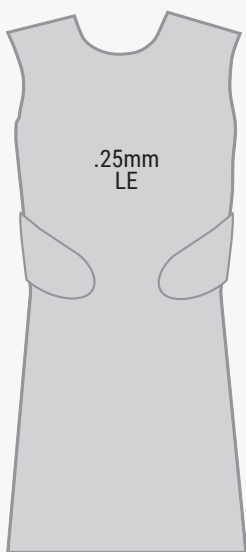

603 and B603 back panels are .25mm LE.

### Full Overlap

REVOLUTION full wrap vest and skirt aprons require a full overlap to achieve the stated protection level.

**REVOLUTION**  
703, 803

.50mm LE

.50mm LE

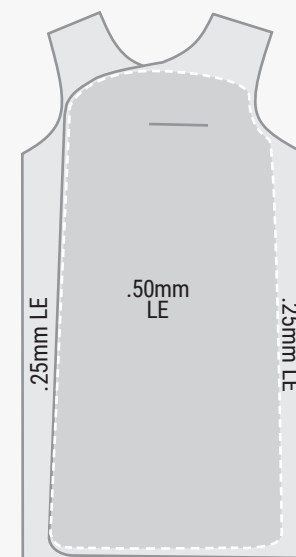
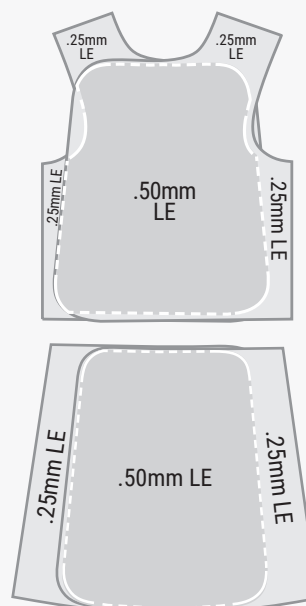

.50mm LE

All back panels are .25mm LE. All skirts are .50mm LE at overlap.



## 103 REVOLUTION VEST & SKIRT

- COLORS:** 500 Series, 600 Series, 700 Series, 800 Series, 900 Series, Remix
- CORE:** Lightweight Lead, KIARMOR Bi-Layer Low-Lead, KIARMOR Bi-Layer Lead-Free
- PROTECTION:** .25mm LE, .35mm LE, .50mm LE
- SIZES:** Female XS-5XL, Male S-5XL (Length alteration  $\pm 2''$  or  $\pm 4''$ )
- FABRIC:** Revolution Fabric with Cool Wear
- OPTIONAL BASE:** B103 Classic Nylon Colors without Cool Wear (Custom alterations)
- MONOGRAM:** **Block** or *Script*

- Features interior pocket on both vest and skirt
- "Back Flap" for better weight balance
- Removable Black Belt® in skirt for better lumbar support
- Partial overlap to increase protection
- Cool Wear moisture-wicking interior fabric
- Professionally designed for an exceptional fit and comfort
- SmartTrack enabled



Optional Hook & Loop Closure Attached Belt

### RADIATION PROTECTION OPTIONS

STANDARD CONFIGURATION		OPTION 1		OPTION 2	
.50mm LE		.35mm LE		.25mm LE	
Absorbed Dose	Attenuation	Absorbed Dose	Attenuation	Absorbed Dose	Attenuation
0.9%	99.1%	2.45%	97.6%	4.9%	95.1%
0.6%	99.4%	1.9%	98.1%	3.5%	96.5%
0.6%	99.4%	2.0%	98.0%	3.9%	96.1%
Highest Protection		Best Combination of Protection & Weight		Lightest Weight	



Shown in 808 Sky Blue/White

Back panel is always .25mm LE unless requested otherwise

# L103 REVOLUTION LUMBAR VEST & SKIRT

- COLORS:** 500 Series, 600 Series, 700 Series, 800 Series, 900 Series, Remix
- CORE:** Lightweight Lead, KIARMOR Bi-Layer Low-Lead, KIARMOR Bi-Layer Lead-Free
- PROTECTION:** .25mm LE, .35mm LE, .50mm LE
- SIZES:** Female XS-5XL, Male S-5XL (Length alteration  $\pm 2"$  or  $\pm 4"$ )
- FABRIC:** Revolution Fabric with Cool Wear
- OPTIONAL BASE:** BL103 Classic Nylon Colors without Cool Wear (Custom alterations)
- MONOGRAM:** *Block* or *Script*

- Features interior pocket on both vest and skirt
- "Back Flap" for better weight balance
- Built-in Black Belt® in Vest and Skirt for better lumbar support
- Partial overlap to increase protection
- Cool Wear Moisture-Wicking interior fabric
- Professionally designed for an exceptional fit and comfort
- SmartTrack Track enabled



Optional Hook & Loop Closure Attached Belt

## RADIATION PROTECTION OPTIONS

STANDARD CONFIGURATION		OPTION 1		OPTION 2	
.50mm LE		.35mm LE		.25mm LE	
Absorbed Dose	Attenuation	Absorbed Dose	Attenuation	Absorbed Dose	Attenuation
0.9%	99.1%	2.45%	97.6%	4.9%	95.1%
0.6%	99.4%	1.9%	98.1%	3.5%	96.5%
0.6%	99.4%	2.0%	98.0%	3.9%	96.1%
Highest Protection		Best Combination of Protection & Weight		Lightest Weight	



Back panel is always .25mm LE unless requested otherwise



Shown in 711 White



## 203 REVOLUTION FULL WRAP BLACK BELT®

- COLORS:** 500 Series, 600 Series, 700 Series, 800 Series, 900 Series, Remix
- CORE:** Lightweight Lead, KIARMOR Bi-Layer Low-Lead, KIARMOR Bi-Layer Lead-Free
- PROTECTION:** .25mm LE, .35mm LE, .50mm LE
- SIZES:** Female XS-5XL, Male S-5XL (Length alteration  $\pm 2"$  or  $\pm 4"$ )
- FABRIC:** Revolution Fabric with Cool Wear
- OPTIONAL BASE:** B203 Classic Nylon Colors without Cool Wear (Custom alterations)
- MONOGRAM:** *Block* or *Script*



Hook and loop closure side slits

- Partial overlap to increase protection
- Hook and loop closure side slits for increased mobility
- Cool Wear moisture-wicking interior fabric
- Professionally designed for an exceptional fit and comfort
- Snap on, fully adjustable Black Belt®
- SmartTrack enabled

### RADIATION PROTECTION OPTIONS

STANDARD CONFIGURATION		OPTION 1		OPTION 2	
.50mm LE		.35mm LE		.25mm LE	
Absorbed Dose	Attenuation	Absorbed Dose	Attenuation	Absorbed Dose	Attenuation
0.9%	99.1%	2.45%	97.6%	4.9%	95.1%
0.6%	99.4%	1.9%	98.1%	3.5%	96.5%
0.6%	99.4%	2.0%	98.0%	3.9%	96.1%
Highest Protection		Best Combination of Protection & Weight		Lightest Weight	



Shown in 616 Black/Volt

Back panel is always .25mm LE unless requested otherwise

### 303 REVOLUTION FRONT



Back closure  
Shown in 814 Jewelry Box Blue/White

### 403 REVOLUTION FRONT ELASTIC BACK



Elastic back closure  
Shown in 615 Black/Orange

### 303 & 403 Product Information

- COLORS:** 500 Series, 600 Series, 700 Series, 800 Series, 900 Series, Remix
- CORE:** Lightweight Lead, KIARMOR Bi-Layer Low-Lead, KIARMOR Bi-Layer Lead-Free
- PROTECTION:** .25mm LE, .35mm LE, .50mm LE
- SIZES:** Female XS-5XL, Male S-5XL (Length alteration  $\pm 2"$  or  $\pm 4"$ )
- FABRIC:** Revolution Fabric with Cool Wear
- OPTIONAL BASE:** B303, B403 Classic Nylon Colors without Cool Wear (Custom alterations)
- MONOGRAM:** *Block* or *Script*

- Cool Wear moisture-wicking interior fabric
- Professionally designed for an exceptional fit and comfort
- SmartTrack enabled

### RADIATION PROTECTION OPTIONS

STANDARD CONFIGURATION		OPTION 1		OPTION 2	
.50mm LE		.35mm LE		.25mm LE	
Absorbed Dose	Attenuation	Absorbed Dose	Attenuation	Absorbed Dose	Attenuation
0.9%	99.1%	2.45%	97.6%	4.9%	95.1%
0.6%	99.4%	1.9%	98.1%	3.5%	96.5%
0.6%	99.4%	2.0%	98.0%	3.9%	96.1%
Highest Protection		Best Combination of Protection & Weight		Lightest Weight	



## 503 REVOLUTION FRONT BLACK BELT®



Built-in back strap  
Shown in 502  
Fuchsia/Black

- COLORS:** 500 Series, 600 Series, 700 Series, 800 Series, 900 Series, Remix
- CORE:** Lightweight Lead, KIARMOR Bi-Layer Low-Lead, KIARMOR Bi-Layer Lead-Free
- PROTECTION:** .25mm LE, .35mm LE, .50mm LE
- SIZES:** Female XS-5XL, Male S-5X L (Length alteration ±2" or ±4")
- FABRIC:** Revolution Fabric with Cool Wear
- OPTIONAL BASE:** B503 Classic Nylon Colors without Cool Wear (Custom alterations)
- MONOGRAM:** Block or Script

## 603 UNISEX REVOLUTION FULL WRAP ELASTIC BACK



Shown in 616  
Black/Volt

- COLORS:** 500 Series, 600 Series, 700 Series, 800 Series, 900 Series, Remix
- CORE:** Lightweight Lead, KIARMOR Bi-Layer Low-Lead, KIARMOR Bi-Layer Lead-Free
- PROTECTION:** .25mm LE, .35mm LE, .50mm LE
- SIZES:** Unisex XS-5XL (Length alteration ±2" or ±4")
- FABRIC:** Revolution Fabric with Cool Wear
- OPTIONAL BASE:** B603 Classic Nylon Colors without Cool Wear (Custom alterations)
- MONOGRAM:** Block or Script

### 503 & 603 RADIATION PROTECTION OPTIONS



STANDARD CONFIGURATION		OPTION 1		OPTION 2	
.50mm LE		.35mm LE		.25mm LE	
Absorbed Dose	Attenuation	Absorbed Dose	Attenuation	Absorbed Dose	Attenuation
0.9%	99.1%	2.45%	97.6%	4.9%	95.1%
0.6%	99.4%	1.9%	98.1%	3.5%	96.5%
0.6%	99.4%	2.0%	98.0%	3.9%	96.1%
Highest Protection		Best Combination of Protection & Weight		Lightest Weight	

### 603 UNISEX SIZING

	Bust	Waist
X-Small	30-33" / 76-84 cm	25-27" / 64-69 cm
Small	34-37" / 86-94 cm	28-31" / 71-79 cm
Medium	38-41" / 97-104 cm	32-35" / 81-89 cm
Large	42-45" / 107-114 cm	36-39" / 91-99 cm
X-Large	46-49" / 117-125 cm	40-43" / 102-109 cm
XX-Large	50-52" / 127-132 cm	44-46" / 112-117 cm

- Cool Wear moisture-wicking interior fabric
- Professionally designed for an exceptional fit and comfort
- 503 comes with a snap on, fully adjustable Black Belt®
- SmartTrack enabled

603 back panel is always .25mm LE unless requested otherwise



Shown in 505 Navy/Black

NEW

**703** **REVOLUTION FULL OVERLAP LUMBAR VEST & SKIRT**  
FULL OVERLAP

The 703 brings the Classic Infab design into the Revolution line, adding a Black Belt® for additional lumbar support. This full overlap apron is lightweight, offers great protection, and has a Classic fit.

**COLORS:** 500 Series, 600 Series, 700 Series, 800 Series, 900 Series, Remix

**CORE:** Lightweight Lead, KIARMOR Bi-Layer Low-Lead, KIARMOR Bi-Layer Lead-Free

**PROTECTION:** .50mm LE

**SIZES:** Female XS-5XL, Male S-5XL (Length alteration ±2" or ±4")

**FABRIC:** Revolution Fabric with Cool Wear

**MONOGRAM:** Block or Script

- Full overlap
- Cool Wear moisture-wicking interior fabric
- Professionally designed for an exceptional fit and comfort
- Built-in Black Belt® in vest and skirt for better lumbar support
- SmartTrack enabled

Optional Hook & Loop Closure Attached Belt



KTC Buckle to keep belt attached and in place.

RADIATION PROTECTION

STANDARD CONFIGURATION	
.50mm LE	
Absorbed Dose	Attenuation
0.9%	99.1%
0.6%	99.4%
0.6%	99.4%
Highest Protection	



Back panel is always .25mm LE unless requested otherwise



All new color block design for 703. Inside panel of vest & skirt





## 803 REVOLUTION BLACK BELT® WRAP

- COLORS:** 500 Series, 600 Series, 700 Series, 800 Series, 900 Series, Remix
- CORE:** Lightweight Lead, KIARMOR Bi-Layer Low-Lead, KIARMOR Bi-Layer Lead-Free
- PROTECTION:** .50mm LE
- SIZES:** Female XS-5XL, Male S-5XL (Length alteration ±2" or ±4")
- FABRIC:** Revolution Fabric with Cool Wear
- MONOGRAM:** Block or Script

- Full overlap
- Hook and loop closure side slits for increased mobility
- Cool Wear moisture-wicking interior fabric
- Professionally designed for an exceptional fit and comfort
- Snap on, fully adjustable Black Belt®
- SmartTrack enabled



Hook and loop closure side slits

Shown in Remix Volt/Grey

### RADIATION PROTECTION

STANDARD CONFIGURATION	
.50mm LE	
Absorbed Dose	Attenuation
0.9%	99.1%
0.6%	99.4%
0.6%	99.4%
Highest Protection	

Back panel is always .25mm LE unless requested otherwise



# REVOLUTION

## BASE APRONS

Revolution Base offers all the comfort and protection of our premium Revolution line but with our classic nylon colors and patterns. Revolution Base does not include Revolution Fabric, Color-Blocking or Cool-Wear.



**BL103**  
**REVOLUTION LUMBAR VEST & SKIRT BASE**



**B103**  
**REVOLUTION VEST & SKIRT BASE**



**B203**  
**REVOLUTION FULL WRAP BLACK BELT® BASE**



**B303**  
**REVOLUTION FRONT BASE**



**B403**  
**REVOLUTION FRONT ELASTIC BACK BASE**



**B503**  
**REVOLUTION FRONT BLACK BELT® BASE**



**B603**  
**REVOLUTION ELASTIC BACK FULL WRAP BASE**

## REVOLUTION THYROID COLLARS

Please take note of the various color combinations on Revolution thyroid collars and order your monogram colors accordingly

**500 SERIES**  
**COLOR BLOCK: BLACK**



**BIB: COLOR**

**600 SERIES**  
**COLOR BLOCK: COLOR**



**BIB: BLACK**

**700 SERIES**  
**NECK: COLOR**



**BIB: COLOR**

**800 SERIES**  
**COLOR BLOCK: WHITE**



**BIB: COLOR**

**900 SERIES**  
**COLOR BLOCK: COLOR**



**BIB: WHITE**

**REMIX**  
**COLOR SERIES**  
**COLOR BLOCK: COLOR**



**BIB: COLOR**

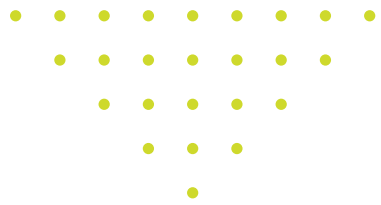

# REVOLUTION COLORS



## 500 SERIES

Main: Color  
Block: Black



## 600 SERIES

Main: Black  
Block: Color



- 501 Red/Black
- 502 Fuchsia/Black
- 503 Taupe/Black
- 504 Pink/Black
- 505 Navy/Black
- 506 Teal/Black
- 507 Yellow/Black
- 508 Sky Blue/Black



- 601 Black / Red
- 602 Black/ Fuchsia
- 603 Black/ Taupe
- 604 Black/ Pink
- 605 Black/ Navy
- 606 Black/ Teal
- 607 Black/ Yellow
- 608 Black/ Sky Blue



- 509 Grey/Black
- 510 Purple/Black
- 511 White/Black
- 512 Ducks Green/Black
- 513 Tide Red/Black
- 514 Jewelry Box Blue/Black
- 515 Orange/Black
- 516 Volt/Black
- 517 Light Blue Serenity/Black



- 609 Black/ Grey
- 610 Black/ Purple
- 611 Black/ White
- 612 Black/ Ducks Green
- 613 Black/ Tide Red
- 614 Black/ Jewelry Box Blue
- 615 Black/ Orange
- 616 Black/ Volt
- 617 Black/ Light Blue Serenity

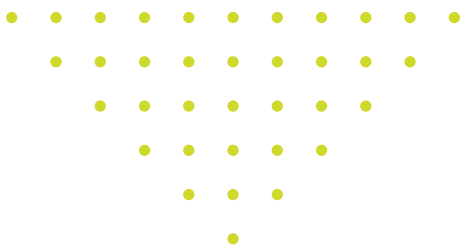

# REVOLUTION COLORS

## 700 SERIES

Main: Color  
Block: None



## 800 SERIES

Main: Color  
Block: White



**REMIX**  
COLOR SERIES

MIX & MATCH  
ANY TWO COLORS

Upcharge applies.



REVOLUTION  
COLORS

**900 SERIES**

Main: White  
Block: Color



Choose one  
main color.



Choose one  
color block color.

**NEW**

ADD ANY **STANDARD**  
INTERIOR COLOR OR PATTERN ON  
THE **INSIDE OF YOUR APRON**



- 901** White/Red
- 902** White/Fuchsia
- 903** White/Taupe
- 904** White/Pink
- 905** White/Navy
- 906** White/Teal
- 907** White/Yellow
- 908** White/Sky Blue



- 909** White/Grey
- 910** White/Purple
- 912** White/Ducks Green
- 913** White/Tide Red
- 914** White/Jewelry Box Blue
- 915** White/Orange
- 916** White/Volt
- 917** White/Light Blue Serenity

FEMALE

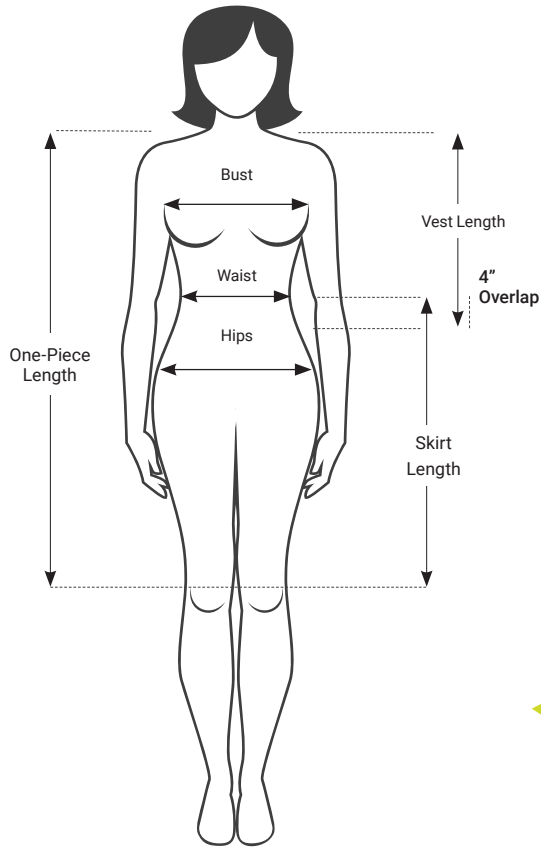

MALE

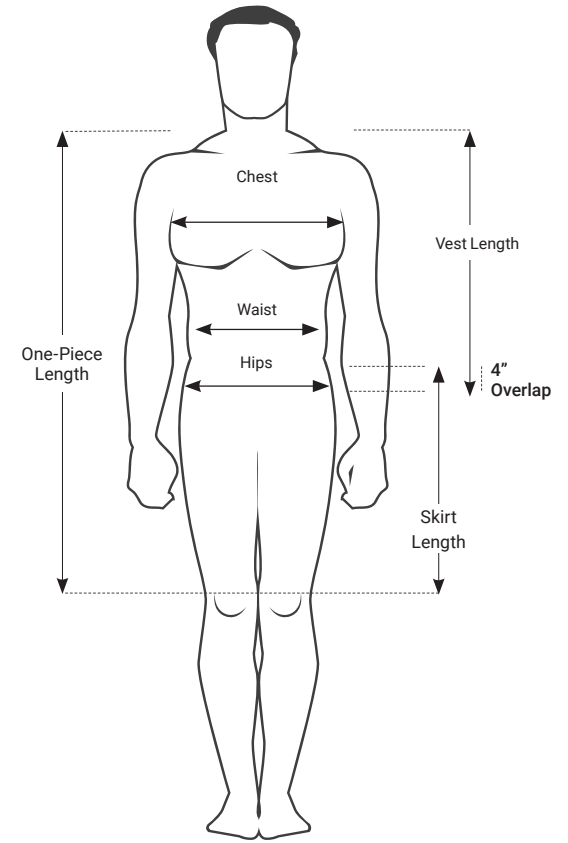

Female Frames

	X-Small	Small	Medium	Large	X-Large	XX-Large
Bust	30-32" / 76-81 cm	33-36" / 84-91 cm	37-39" / 94-99 cm	40-42" / 102-107 cm	43-45" / 109-114 cm	46-48" / 117-122 cm
Waist	25-27" / 64-69 cm	28-30" / 71-76 cm	31-33" / 78-84 cm	34-36" / 86-91 cm	37-39" / 94-99 cm	40-42" / 102-107 cm

Male Frames

	Small	Medium	Large	X-Large	XX-Large
Chest	34-37" / 86-94 cm	38-41" / 97-104 cm	42-45" / 107-114 cm	46-49" / 117-125 cm	50-52" / 127-132 cm
Waist	28-31" / 71-79 cm	32-35" / 81-89 cm	36-39" / 91-99 cm	40-43" / 102-109 cm	44-46" / 112-117 cm

Female Standard Apron Lengths

	Classic & Revolution Front	Full Apron	Classic Vest, 703 Vest	Reverse Vest, Elastic Vest	Classic Skirt	Revolution Vest Front	Revolution Vest Back	Revolution Skirt
X-Small	38" / 97 cm	38" / 97 cm	20" / 51 cm	24" / 61 cm	18" / 46 cm	22" / 56 cm	26" / 66 cm	22" / 56 cm
Small	38" / 97 cm	38" / 97 cm	22" / 56 cm	24" / 61 cm	20" / 51 cm	22" / 56 cm	26" / 66 cm	22" / 56 cm
Medium	38" / 97 cm	38" / 97 cm	24" / 61 cm	26" / 66 cm	22" / 56 cm	22" / 56 cm	26" / 66 cm	22" / 56 cm
Large	38" / 97 cm	38" / 97 cm	25" / 64 cm	27" / 69 cm	23" / 58 cm	22" / 56 cm	26" / 66 cm	22" / 56 cm
X-Large	38" / 97 cm	38" / 97 cm	26" / 66 cm	28" / 71 cm	24" / 61 cm	22" / 56 cm	26" / 66 cm	22" / 56 cm
XX-Large	38" / 97 cm	38" / 97 cm	27" / 69 cm	29" / 74 cm	25" / 64 cm	24" / 61 cm	28" / 66 cm	22" / 56 cm

Male Standard Apron Lengths

	Classic & Revolution Front	Full Apron	Classic Vest, 703 Vest	Reverse Vest, Elastic Vest	Classic Skirt	Revolution Vest Front	Revolution Vest Back	Revolution Skirt
Small	38" / 97 cm	38" / 97 cm	22" / 56 cm	25" / 64 cm	20" / 51 cm	24" / 61 cm	28" / 71 cm	22" / 56 cm
Medium	38" / 97 cm	38" / 97 cm	24" / 61 cm	27" / 69 cm	22" / 56 cm	24" / 61 cm	28" / 71 cm	22" / 56 cm
Large	38" / 97 cm	38" / 97 cm	25" / 64 cm	28" / 71 cm	23" / 58 cm	24" / 61 cm	28" / 71 cm	22" / 56 cm
X-Large	42" / 107 cm	38" / 97 cm	26" / 66 cm	30" / 76 cm	24" / 61 cm	24" / 61 cm	28" / 71 cm	22" / 56 cm
XX-Large	44" / 112 cm	38" / 97 cm	28" / 71 cm	30" / 76 cm	25" / 64 cm	26" / 66 cm	30" / 71 cm	22" / 56 cm

Contact us for sizes above 2XL

# CLASSIC

## APRONS

The Infab Classic apron line offers thousands of color options and patterns. Discover why for over 30 years Infab has remained the leader in radiation protection lead aprons.

### COMFORT

For over 30 years Infab's Classic apron has been the standard of comfort.

### STYLE

Thousands of colors and patterns to choose from.

### COOL WEAR

Optional moisture-wicking material for inside of apron.

### CUSTOMIZATION

- Colors: Thousands of options available
- Logos: Your company logo
- Monograms: Block and script fonts
- Custom Prints: Design your own apron
- Alterations: Modify for custom fit



# CLASSIC Core Material Configurations

## Full Overlap

CLASSIC full wrap vest and skirt aprons **require** a full overlap to achieve the stated protection level.

### VAS

### LSW, MWA, FCW

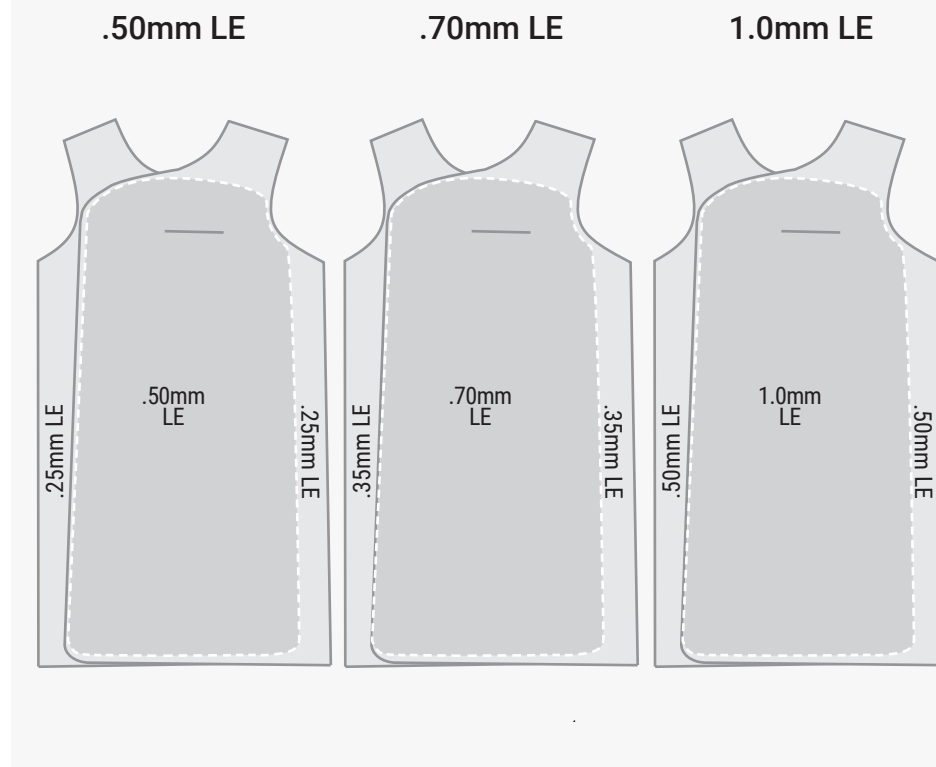
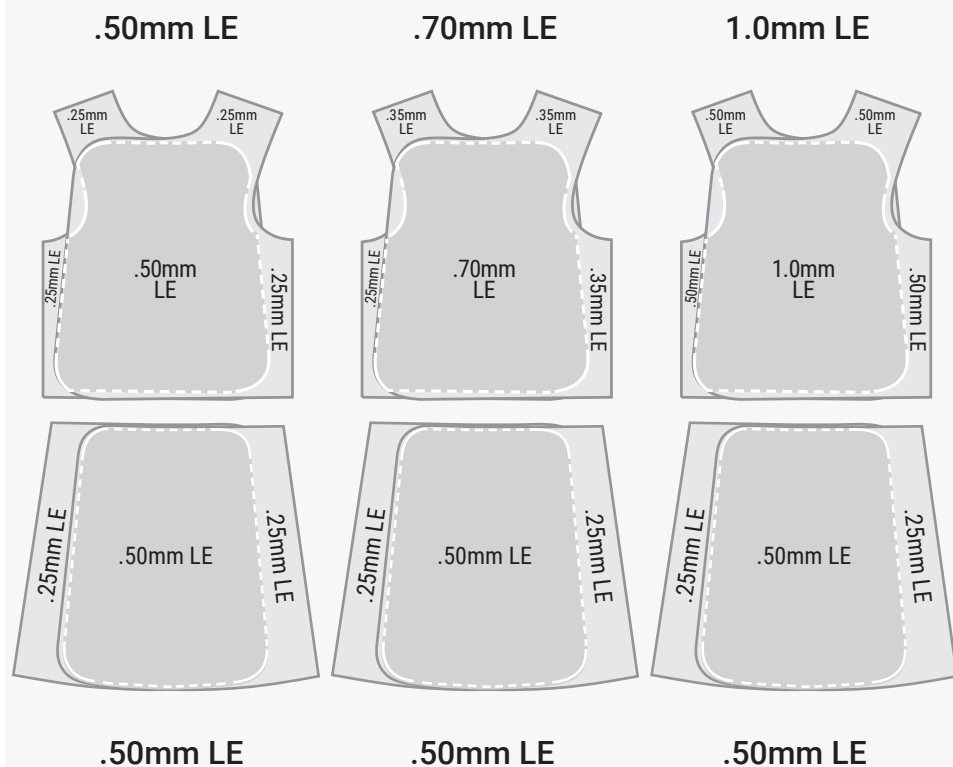

All back panels are .25mm LE. All skirts are .50mm LE at overlap.



CLASSIC Core Material Configurations *Continued*

No Overlap

AWC, EBA, LSF, WBT, SPL, SDO, SDA, TFAM, DTL-TECH  
DTL-PANO, DTL-ADULT, DTL-ADULT-TC, DTL-CHILD, DTL-CHILD-TC

.25mm LE

.35mm LE

.50mm LE

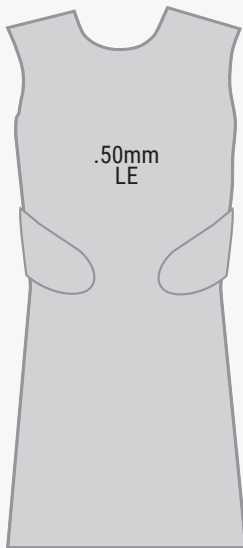
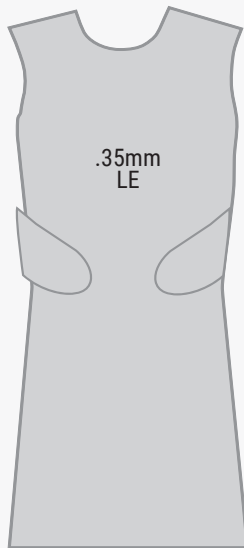
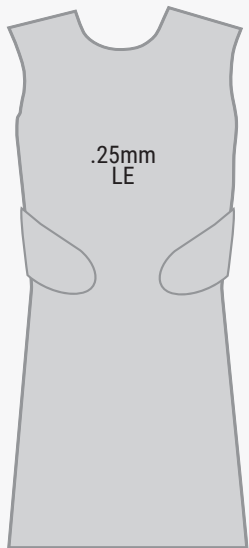

No Overlap Vest. Overlap Skirt.

EVAS, RVAS

.25mm LE

.35mm LE

.50mm LE

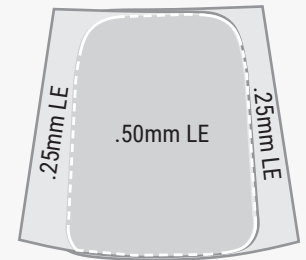
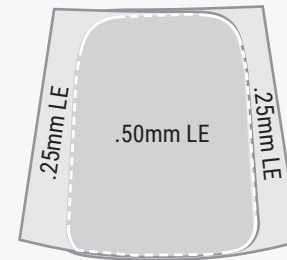
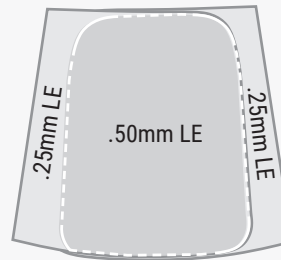

.50mm LE

.50mm LE

.50mm LE

All back panels are .25mm LE. All skirts are .50mm LE at overlap.

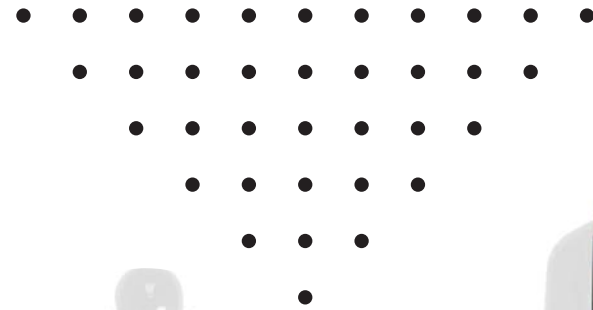

Left Surgery Drop-Away Shoulder Closure



**VAS** VEST & SKIRT

- COLORS:** Classic Nylon Colors
- CORE:** Lightweight Lead, KIARMOR Bi-Layer Low-Lead, KIARMOR Bi-Layer Lead-Free
- PROTECTION:** .50mm LE at overlap on front, .25mm LE on back
- SIZES:** Female XS-5XL, Male S-5XL
- MONOGRAM:** **Block** or *Script*

- Full overlapping front panels for maximum protection
- Hook and loop closures
- Double welt pockets
- Comfortable shoulder pads
- Belt with buckle closure on skirts
- Skirt hanging straps

**RVAS** REVERSE VEST & SKIRT

- COLORS:** Classic Nylon Colors
- CORE:** Lightweight Lead, KIARMOR Bi-Layer Low-Lead, KIARMOR Bi-Layer Lead-Free
- PROTECTION:** .25mm LE, .35mm LE, .50mm LE
- SIZES:** Female XS-5XL, Male S-5XL
- MONOGRAM:** **Block** or *Script*

- Top left shoulder hook and loop closure
- Solid front panel
- Double welt pockets
- Adjustable skirt belt, hook and loop closures
- Criss-cross elastic back for comfortable lumbar support and weight relief
- Skirt hanging straps



Hook and loop closure side slits

**EVAS ELASTIC VEST & SKIRT**

- COLORS:** Classic Nylon Colors
- CORE:** Lightweight Lead, KIARMOR Bi-Layer Low-Lead, KIARMOR Bi-Layer Lead-Free
- PROTECTION:** .25mm LE, .35mm LE, .50mm LE
- SIZES:** Female XS-5XL, Male S-5XL
- MONOGRAM:** *Block* or *Script*

- Built-in 6" orthopedic elastic back for lower back support
- Criss-cross hook and loop closures
- Double welt pockets
- Skirt hanging straps

**LSW BLACK BELT® WRAP**

- COLORS:** Classic Nylon Colors
- CORE:** Lightweight Lead, KIARMOR Bi-Layer Low-Lead, KIARMOR Bi-Layer Lead-Free
- PROTECTION:** .50mm LE at overlap on front, .25mm LE on back
- SIZES:** Female XS-5XL, Male S-5XL
- MONOGRAM:** *Block* or *Script*

- Snap on, fully adjustable elastic Black Belt® for lumbar support
- Comfortable shoulder pads
- Hook and loop closure side slits for increased mobility
- Double welt pockets



Hook and loop closure side slits

**MWA SPECIAL WRAP**

- COLORS:** Classic Nylon Colors
- CORE:** Lightweight Lead, KIARMOR Bi-Layer Low-Lead, KIARMOR Bi-Layer Lead-Free
- PROTECTION:** .5mm LE
- SIZES:** Female XS-5XL, Male S-5XL
- MONOGRAM:** **Block** or *Script*

- Solid front panel design with criss-cross back
- Shoulder strap
- 2" wide buckle closures
- Double welt pockets

**FCW FULL COAT WRAP**

- COLORS:** Classic Nylon Colors
- CORE:** Lightweight Lead, KIARMOR Bi-Layer Low-Lead, KIARMOR Bi-Layer Lead-Free
- PROTECTION:** .50mm LE at overlap on front, .25mm LE on back
- SIZES:** Female XS-5XL, Male S-5XL
- MONOGRAM:** **Block** or *Script*

- Double welt pockets
- Full overlapping front panels
- Hook and loop closure side slits for increased mobility



**AWC** WEIGHT RELIEVER

- COLORS:** Classic Nylon Colors
- CORE:** Lightweight Lead, KIARMOR Bi-Layer Low-Lead, KIARMOR Bi-Layer Lead-Free
- PROTECTION:** .25mm LE, .35mm LE, .50mm LE
- SIZES:** Female XS-5XL, Male S-5XL
- MONOGRAM:** *Block* or *Script*
- Distributes weight between waist and shoulders
  - Comfortable shoulder pads
  - Double welt pockets



**EBA** ELASTIC BACK

- COLORS:** Classic Nylon Colors
- CORE:** Lightweight Lead, KIARMOR Bi-Layer Low-Lead, KIARMOR Bi-Layer Lead-Free
- PROTECTION:** .25mm LE, .35mm LE, .50mm LE
- SIZES:** Female XS-5XL, Male S-5XL
- MONOGRAM:** *Block* or *Script*
- Built-in orthopedic elastic panels for lower back support and comfort
  - Comfortable shoulder pads
  - Double welt pockets



**LSF** BLACK BELT® FRONT

**COLORS:** Classic Nylon Colors  
**CORE:** Lightweight Lead, KIARMOR Bi-Layer Low-Lead, KIARMOR Bi-Layer Lead-Free  
**PROTECTION:** .25mm LE, .35mm LE, .50mm LE  
**SIZES:** Female XS-5XL, Male S-5XL  
**MONOGRAM** **Block** or *Script*

- Comfortable shoulder pads
- Shoulder strap
- Buckle closure in front
- Double welt pockets

**WBT** 2" WIDE BELT

**COLORS:** Classic Nylon Colors  
**CORE:** Lightweight Lead, KIARMOR Bi-Layer Low-Lead, KIARMOR Bi-Layer Lead-Free  
**PROTECTION:** .25mm LE, .35mm LE, .50mm LE  
**SIZES:** Female XS-5XL, Male S-5XL  
**MONOGRAM:** **Block** or *Script*

- Comfortable shoulder pads
- Criss-cross straps with 2" belt buckle
- Double welt pockets



**SPL BUDGET SAVER**

**COLORS:** Classic Nylon Colors  
**CORE:** Lightweight Lead, KIARMOR Bi-Layer Low-Lead, KIARMOR Bi-Layer Lead-Free  
**PROTECTION:** .25mm LE, .35mm LE, .50mm LE  
**SIZES:** Female XS-5XL, Male S-5XL  
**MONOGRAM:** **Block** or *Script*

- Comfortable shoulder pads
- Attaches in front with criss-cross tie straps



**SDO SURGERY DROP OFF SIDE RELEASE**

**COLORS:** Classic Nylon Colors  
**CORE:** Lightweight Lead, KIARMOR Bi-Layer Low-Lead, KIARMOR Bi-Layer Lead-Free  
**PROTECTION:** .25mm LE, .35mm LE, .50mm LE  
**SIZES:** Female XS-5XL, Male S-5XL  
**MONOGRAM:** **Block** or *Script*

- Designed to be removed without breaking sterile field
- No arm holes for easy drop off
- Comfortable shoulder pads
- Attaches in front with hook and loop closures
- Double welt pocket



**SDA** SURGERY DROP OFF SHOULDER RELEASE

**COLORS:** Classic Nylon Colors  
**CORE:** Lightweight Lead, KIARMOR Bi-Layer Low-Lead, KIARMOR Bi-Layer Lead-Free  
**PROTECTION:** .25mm LE, .35mm LE, .50mm LE  
**SIZES:** Female XS-5XL, Male S-5XL  
**MONOGRAM:** *Block* or *Script*

- Designed to be removed without breaking sterile field
- Hook and loop closures at top of both shoulders
- Back attaches with one hook and loop closure strap
- Double welt pocket

**TFAM** TRI-FLAP

**COLORS:** Classic Nylon Colors  
**CORE:** Lightweight Lead, KIARMOR Bi-Layer Low-Lead, KIARMOR Bi-Layer Lead-Free  
**PROTECTION:** .25mm LE, .35mm LE, .50mm LE  
**SIZES:** Female XS-5XL, Male S-5XL  
**MONOGRAM** *Block* or *Script*

- Split front panel for protection and comfort while seated
- Designed to be sat in
- Increased airflow
- Attaches in front with hook and loop closures
- Comfortable shoulder pads
- Double welt pockets





**DTL-TECH** DENTAL TECHNICIAN APRON

**SIZE:** Adult  
**COLORS:** Classic Nylon Colors  
**CORE:** Lightweight Lead, KIARMOR Bi-Layer Low-Lead, KIARMOR Bi-Layer Lead-Free  
**MONOGRAM:** *Block* or *Script*

- 24" W x 36" L
- Arm holes
- Attaches in the back with tie straps
- Front protection only
- .35mm LE

**DTL-PANO** PANO CAPE DENTAL APRON

**SIZE:** Adult  
**COLORS:** Classic Nylon Colors  
**CORE:** Lightweight Lead, KIARMOR Bi-Layer Low-Lead, KIARMOR Bi-Layer Lead-Free  
**MONOGRAM:** *Block* or *Script*

- 23" W x 25" L
- Split in back with hook and loop closure
- .35mm LE
- Non-slip inner material

DENTAL

DTL-ADULT DENTAL APRON

**SIZE:** Adult  
**COLORS:** Classic Nylon Colors  
**CORE:** Lightweight Lead, KIARMOR Bi-Layer Low-Lead, KIARMOR Bi-Layer Lead-Free  
**MONOGRAM:** Block or Script

- 24" W x 27" L
- Non-slip inner material
- .35mm LE

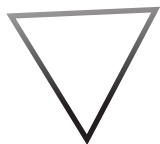

DTL-CHILD CHILD DENTAL APRON

**SIZE:** Child  
**COLORS:** Classic Nylon Colors  
**CORE:** Lightweight Lead, KIARMOR Bi-Layer Low-Lead, KIARMOR Bi-Layer Lead-Free  
**MONOGRAM:** Block or Script

- 18" W x 23" L
- Non-slip inner material
- .35mm LE



**DTL-ADULT**  
 Adult dental apron



**DTL-ADULT-TC**  
 Adult dental apron with attached thyroid collar



**DTL-CHILD**  
 Child dental apron



**DTL-CHILD-TC**  
 Child dental apron with attached thyroid collar

# STANDARD PATTERNS

No Upcharge



SH-1 Graffiti Hearts

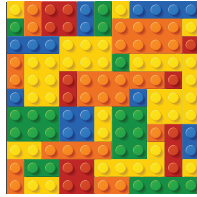

SH-2 Blocks

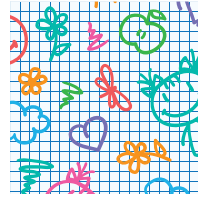

SH-3 Kids Sketch

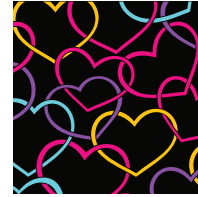

SH-4 Stylized Hearts

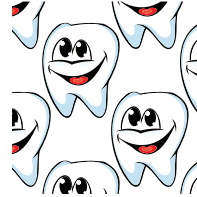

SH-5 Teeth



SH-6 Color Camo



SH-7 Metallic Splatter

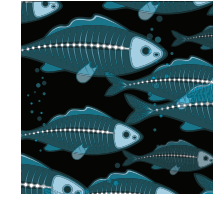

SH-8 Fish Bones



SH-9 Sports



SH-10 Cats



SH-11 Red Plaid

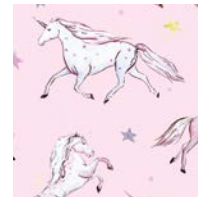

SH-12 Unicorn

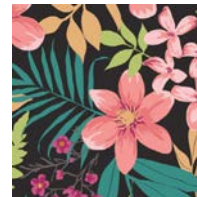

SH-13 Hawaiian Flowers



SH-14 Dino Fossil

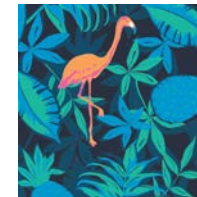

SH-15 Flamingo



SH-16 Purple Plaid



SH-17 Race Car



SH-18 Shape Camo



SH-19 Pink Paisley



SH-20 New Flames



SH-21 Volleyball

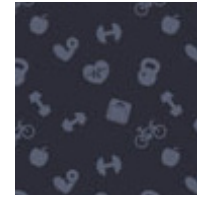

SH-22 Fitness

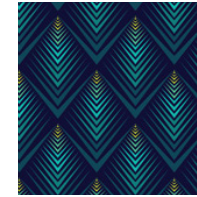

SH-23 Art Deco



SH-24 Cactus



SH-25 Emoji

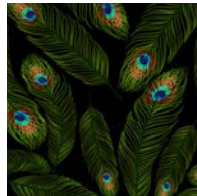

SH-26 Peacock



SH-27 Orange Blocks



SH-28 80's Palm



SH-29 Planets



SH-30 Sharks



SH-31 Sugar Skulls



SH-32 Orange Hibiscus



SH-33 Christmas Sweater

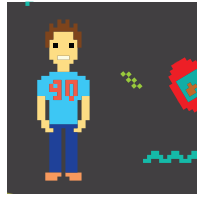

SH-34 8-Bit

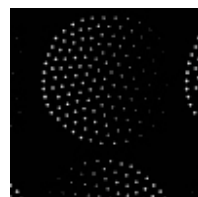

SH-35 Moon Cycle



SH-36 Color Fossils



SH-37 Dachsund



SH-38 Astronaut



SH-39 Space Fun



SH-40 Frenchies

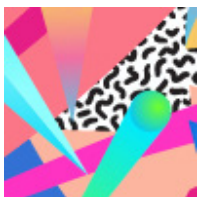

SH-42 80's

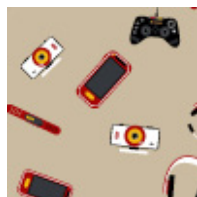

SH-43 Gamer

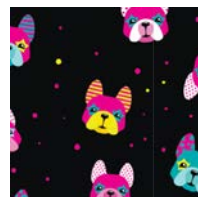

SH-44 Abstract Frenchies

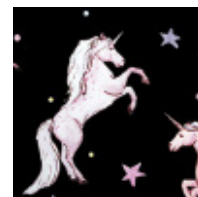

SH-48 Black Unicorn

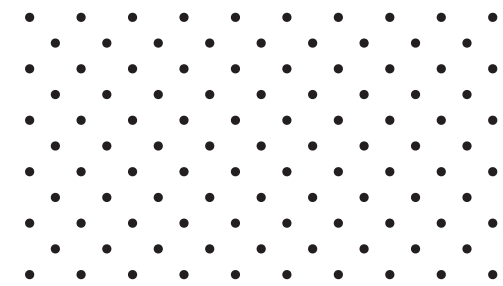

No Upcharge

STANDARD PATTERNS



120 Camouflage

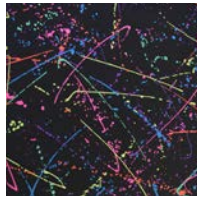

140 Splash



157 Teal Plaid



166 Zebra



167 Cheetah



168 New Jeans



169 Surf Wax

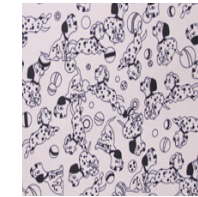

172 Puppies



174 Leather



176 Rainbow Wave



177 Butterflies



179 New Gumball



180 Orange Hawaii



182 Sheep in Clouds



184 Pink Camouflage

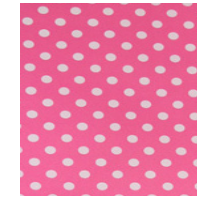

185 White Dots on Pink

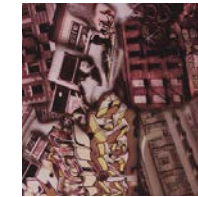

188 American Graffiti



201 Digital Camo

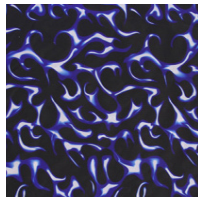

207 Blue Flame

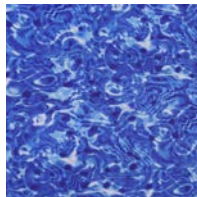

208 Blue Wash

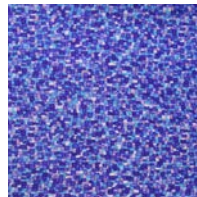

209 Chicklets



210 Skulls

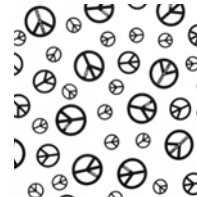

211 Peace

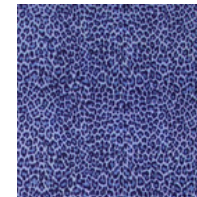

212 Animal Print Blue

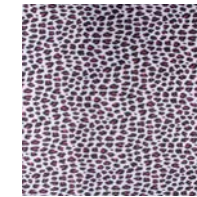

214 Animal Print Pink

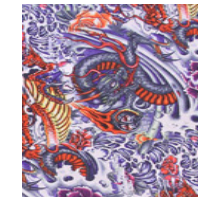

216 Asian

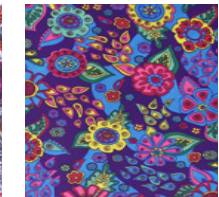

217 Mardi Gras



218 Mamba



219 Pink Paws



261 Red Skulls



262 Black Butterflies



263 Chocolate Giraffe

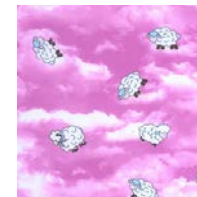

264 Sheep in Clouds Pink

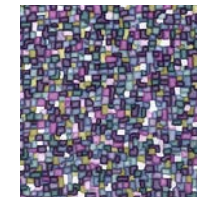

265 Chicklets Purple

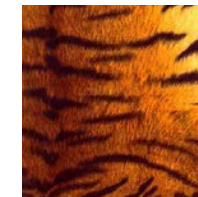

266 Tiger Skin



267 Abstract Hearts



268 Digital Camo Black



269 Animal Farm

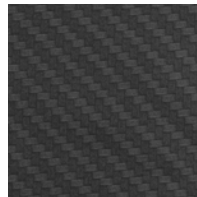

251 Carbon Fiber

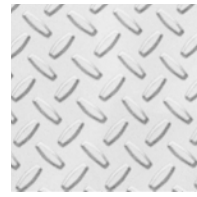

252 Steel

Colors and patterns may be added or discontinued at any time. For the most up-to-date list of Apron Colors, visit [www.infabcorp.com/colors](http://www.infabcorp.com/colors).

# STANDARD COLORS

No Upcharge

First quality nylon and polyesters, all polyurethane coated on the inside to seal the cloth from any fluid penetration and for ease-of-cleaning. Color-fast dyes won't transfer to your clothing. Colors and patterns may be added and discontinued at any time. For the most up to date list of apron colors, visit [www.infabcorp.com/colors](http://www.infabcorp.com/colors)

Mix Colors/Patterns and Trims  
Create Your Own Unique Look at No Extra Charge

 121 Pink is not available as an inside color. All other standard colors may be selected. 112 Grey is the standard inside color when ordering 121 Pink.

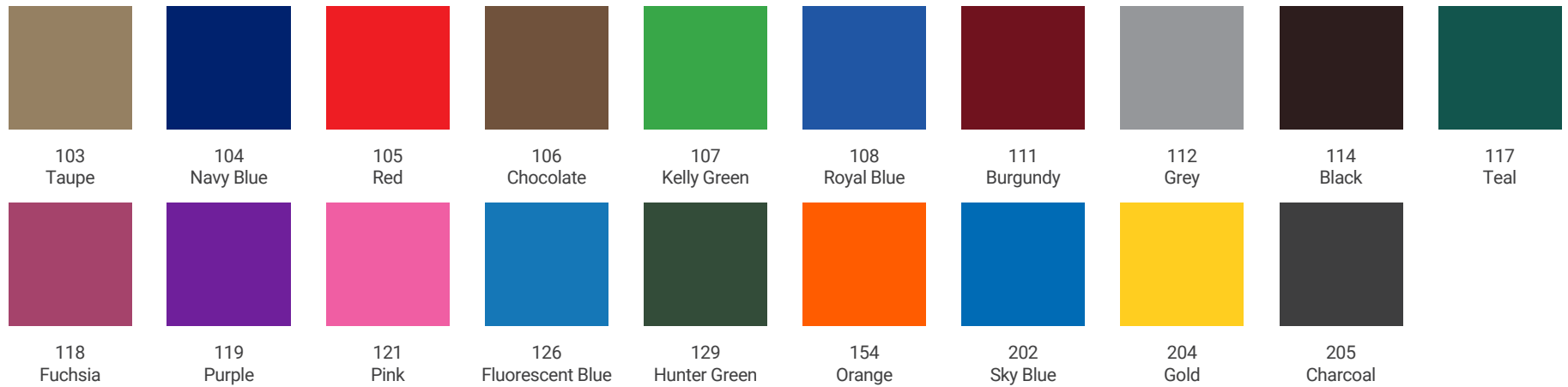

# DIAMOND RIPSTOPS

No Upcharge

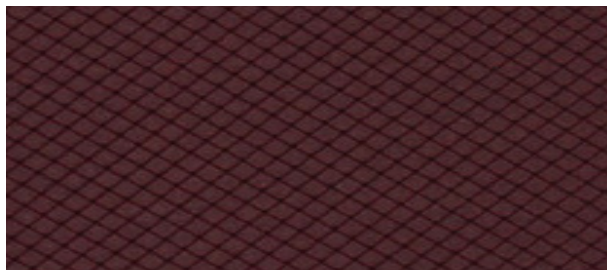





















# IN STOCK PREMIUMS Premium Upcharge

Infab offers the following in stock premiums. Choosing from one of these colors provides a faster ship time and a complete custom look for your apron.

								
SCP258-54 Vintage Postcard	TFX755-45 New Purple Plaid	SCP304-09 Dog Paw	SCP337-57 America Stars	MIR222-55 Denim Pockets	SCP305-95 Dalmatians	TFX755-31 New Pink Plaid	TFX778-57 Blue Mamba	TRP539-07 Dila Dot
								
TRP549-55 Hatchet Blue	MIR280-05 Galaxy Red	TRTB-NC65 Timber Camo	DSC01-01 Desert Camo	TFX767-37 Baby Leo	CAS009-33 Wildcat Pink	TRTB-MC2 Snow Camo	MIR215-51 Blue Camo	MIR215-55 Navy Camo
								
MIR239-53 Happy Talk	SCP084-60 Dancing Zebras	MIR260-03 Candy Circles	MIR267-09 Tahiti Black	MIR272-33 Mantis Pink	MIR272-53 Mantis Blue	MIR278-09 Crayon Hearts	MIR280-09 Galaxy Black	MIR289-95 Toxic Graffiti
								
MIR285-57 Star Gazer	TXF779-44 Mystery Splash	SCP088-43 Purple Flame	SCP088-92 Orange Flame	SCP244-85 Teal Splash	SCP098-82 Red Cherries	SCP139-13 Green Lantern	SCP145-95 Red Granite	SCP393-09 Hounds Tooth

Additional custom colors are also available at [Infabcorp.com/colors](http://Infabcorp.com/colors). These are not in stock and require a longer lead time. Premium upcharge applies.

## TRIM, HOOK AND LOOP CLOSURE OPTIONS

										
103 Taupe	104 Navy Blue	105 Red	106 Chocolate	107 Kelly Green	108 Royal Blue	110 Tan <b>Hook and Loop Closure Only</b>	111 Burgundy	112 Grey	114 Black	117 Teal
										
118 Fuchsia	119 Purple	124 Fluorescent Pink <b>Hook and Loop Closure Only</b>	126 Fluorescent Blue	129 Hunter Green	154 Orange	203 Powder Blue <b>Trim Only</b>	204 Gold	205 Charcoal		



## CUSTOM OPTIONS

### Logo Fabrics

Infab offers the ability to use and customize your logo on our Classic fabric.

### Custom Fabric

Infab offers the ability to make custom fabrics for any of our Classic style radiation protection aprons. We work with you to create a unique, one-of-a-kind design, to make your apron feel like your own.

FEMALE

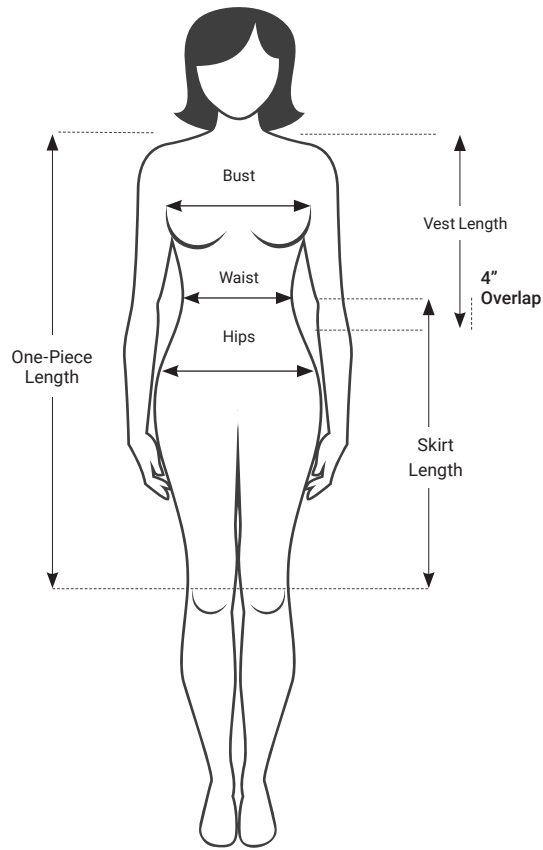

MALE

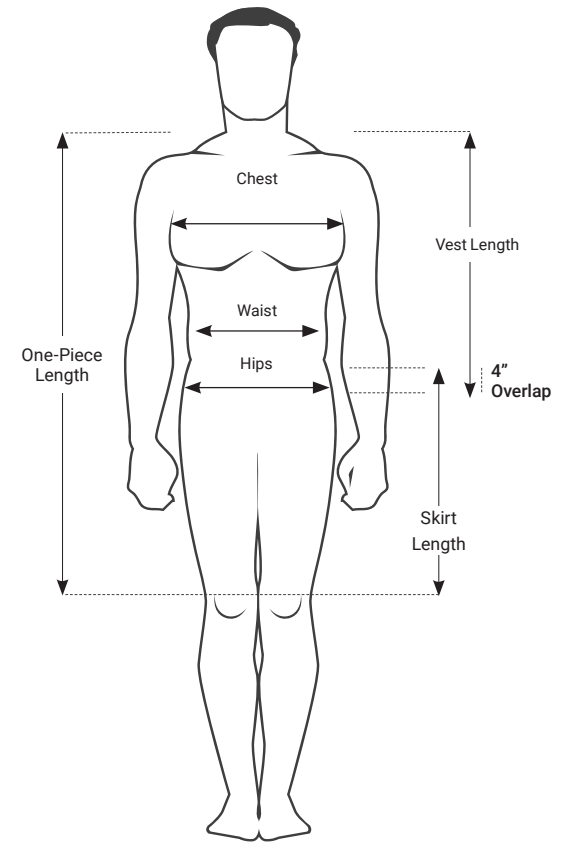

Female Frames

	X-Small	Small	Medium	Large	X-Large	XX-Large
Bust	30-32" / 76-81 cm	33-36" / 84-91 cm	37-39" / 94-99 cm	40-42" / 102-107 cm	43-45" / 109-114 cm	46-48" / 117-122 cm
Waist	25-27" / 64-69 cm	28-30" / 71-76 cm	31-33" / 78-84 cm	34-36" / 86-91 cm	37-39" / 94-99 cm	40-42" / 102-107 cm

Male Frames

	Small	Medium	Large	X-Large	XX-Large
Chest	34-37" / 86-94 cm	38-41" / 97-104 cm	42-45" / 107-114 cm	46-49" / 117-125 cm	50-52" / 127-132 cm
Waist	28-31" / 71-79 cm	32-35" / 81-89 cm	36-39" / 91-99 cm	40-43" / 102-109 cm	44-46" / 112-117 cm

Female Standard Apron Lengths

	Classic & Revolution Front	Full Apron	Classic Vest, 703 Vest	Reverse Vest, Elastic Vest	Classic Skirt	Revolution Vest Front	Revolution Vest Back	Revolution Skirt
X-Small	38" / 97 cm	38" / 97 cm	20" / 51 cm	24" / 61 cm	18" / 46 cm	22" / 56 cm	26" / 66 cm	22" / 56 cm
Small	38" / 97 cm	38" / 97 cm	22" / 56 cm	24" / 61 cm	20" / 51 cm	22" / 56 cm	26" / 66 cm	22" / 56 cm
Medium	38" / 97 cm	38" / 97 cm	24" / 61 cm	26" / 66 cm	22" / 56 cm	22" / 56 cm	26" / 66 cm	22" / 56 cm
Large	38" / 97 cm	38" / 97 cm	25" / 64 cm	27" / 69 cm	23" / 58 cm	22" / 56 cm	26" / 66 cm	22" / 56 cm
X-Large	38" / 97 cm	38" / 97 cm	26" / 66 cm	28" / 71 cm	24" / 61 cm	22" / 56 cm	26" / 66 cm	22" / 56 cm
XX-Large	38" / 97 cm	38" / 97 cm	27" / 69 cm	29" / 74 cm	25" / 64 cm	24" / 61 cm	28" / 66 cm	22" / 56 cm

Male Standard Apron Lengths

	Classic & Revolution Front	Full Apron	Classic Vest, 703 Vest	Reverse Vest, Elastic Vest	Classic Skirt	Revolution Vest Front	Revolution Vest Back	Revolution Skirt
Small	38" / 97 cm	38" / 97 cm	22" / 56 cm	25" / 64 cm	20" / 51 cm	24" / 61 cm	28" / 71 cm	22" / 56 cm
Medium	38" / 97 cm	38" / 97 cm	24" / 61 cm	27" / 69 cm	22" / 56 cm	24" / 61 cm	28" / 71 cm	22" / 56 cm
Large	38" / 97 cm	38" / 97 cm	25" / 64 cm	28" / 71 cm	23" / 58 cm	24" / 61 cm	28" / 71 cm	22" / 56 cm
X-Large	42" / 107 cm	38" / 97 cm	26" / 66 cm	30" / 76 cm	24" / 61 cm	24" / 61 cm	28" / 71 cm	22" / 56 cm
XX-Large	44" / 112 cm	38" / 97 cm	28" / 71 cm	30" / 76 cm	25" / 64 cm	26" / 66 cm	30" / 71 cm	22" / 56 cm

Contact us for sizes above 2XL



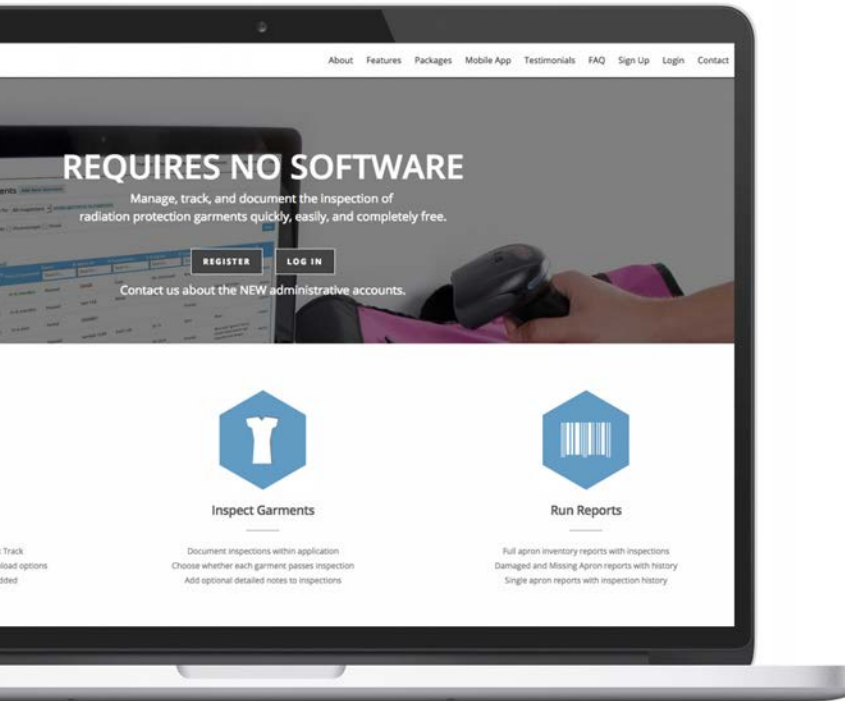

## WEB-BASED APRON TRACKING



[smartrack.infabcorp.com](https://smartrack.infabcorp.com)

Manage, track, and document the inspection of radiation protection garments quickly, easily and completely FREE.

SMART TRACK provides facilities with a simplified and user friendly process to document inspections and print detailed reports for audits from authoritative governing bodies. SMART TRACK does not change your current inspection process it will simply assist in expediting the process.

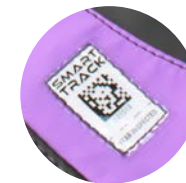

### TAGS

Included on all new Infab aprons.  
Retrofit options available.

### FEATURES

- Add various users (administrators/inspectors/view only) to your account to assist in the inspection process
- Able to be provided access to multiple accounts for health systems with multiple facilities
- Generate full inventory detailed reports making annual audits seamless
- Dispose of failed garments directly from your account (free service offered by Infab)
- Scan and document apron inspections directly from your mobile phone utilizing the free mobile Smart Track application

### BENEFITS

- NO Software, NO Registration/Annual Fees
- Expedite and Streamline the inspection process
- Assistance provided with Smart Track implementation, including inventory upload
- User-friendly design allows for simple integration

### ADD GARMENT INFORMATION AUTO-POPULATION

When you scan or enter an ID to add an Infab apron, the information will auto-populate.



### SECURE

Requires no software.  
Register for free.

## RETROFIT ANY EXISTING APRONS

including non Infab brands

Smart Track Scanner and Smart Track Tags with Backing



200 Annual Inspection Stickers



200 SMART TRACK 2D bar code tags with permanent security-style backing



SMART TRACK Scanner

## MOBILE APP

The SMART TRACK mobile app makes it easy to scan and track all of the aprons in a department or facility. The SMART TRACK app has all the features of the web-based version of SMART TRACK but also includes a built in scanner. The SMART TRACK app requires no sign up fee and no annual fee making it the easiest and best way to track radiation protection garments.

Simply download the app for free, login to your SMART TRACK account and scan and track all of your aprons quickly, easily and completely free.

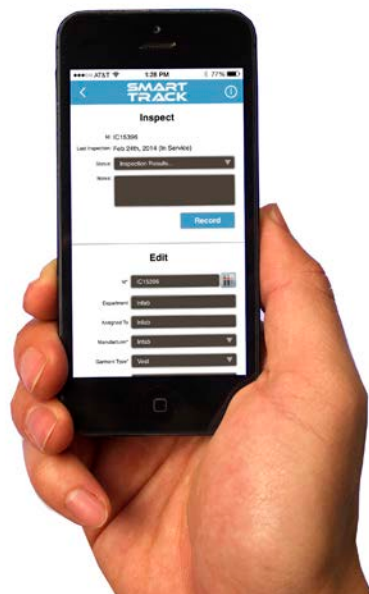

## TESTIMONIALS

"Smart Track makes it simple to manage my suite of lead aprons.

We track over 100 aprons - it saves time and headaches."

Rich Norman  
Lead Tech, Los Robles Hospital  
Thousand Oaks, CA

"Tracking lead aprons and making sure that they have been inspected is a challenge for any large radiology facility. Of the many apron-tracking systems I reviewed, I knew that the "SMART TRACK" Apron inventory system would work for our facility and meet new regulatory standards set by "The Joint Commission"...The system is user friendly. All I know is that anyone who has the burden of tracking aprons needs to get "Smart" about tracking their apron inventory".

Roseann Zeldin, RT, (R) (M), CNMT  
Assistant Radiation Safety Officer, Department of  
Radiology & Imaging, Hospital for Special Surgery-  
New York City, New York



"The SMART TRACK Apron Inventory system has revolutionized the way lead apron quality control testing and inventory management is performed at our facility. It is a superior, comprehensive, and user-friendly product. Individual bar codes make tracking aprons quick and easy. It is the best system I have had the opportunity to work with."

Doug Beardsall MRT (R) CTIC  
Senior Technologist QC, Safety, and Education, Royal  
Victoria Regional Health Center- Barrie, Ontario

**REV-TC** REVOLUTION THYROID COLLAR

**SIZES:** One size fits all  
**COLORS:** 500 Series, 600 Series, 700 Series, 800 Series, 900 Series, Remix  
**CORE:** Lightweight Lead, KIARMOR Bi-Layer Low-Lead, KIARMOR Bi-Layer Lead-Free  
**CLOSURE:** Hook and Loop Closure, Buckle

- Large coverage area
- Exclusive Revolution outer fabric
- Cool Wear moisture-wicking liner
- Optional monogram
- Optional KTC attachment



**NST** THYROID COLLAR WITHOUT BINDING

**SIZES:** X-Small, Standard, Medium  
**COLORS:** Revolution 700 series & All Classic Nylon Colors  
**CORE:** Lightweight Lead, KIARMOR Bi-Layer Low-Lead, KIARMOR Bi-Layer Lead-Free  
**CLOSURE:** Hook and Loop Closure, Buckle, Magnet

- Comfortable fit
- Large protection area
- Optional monogram
- Optional KTC attachment



**SVT** VISOR STYLE THYROID COLLAR

**SIZES:** X-Small, Standard, Medium  
**COLORS:** All  
**CORE:** Lightweight Lead, KIARMOR Bi-Layer Low-Lead, KIARMOR Bi-Layer Lead-Free  
**CLOSURE:** Hook and Loop Closure, Buckle

- Comfortable fit
- Large coverage area
- Optional monogram
- Optional KTC attachment



**MTC** MAGNETIC THYROID COLLAR

**SIZES:** X-Small, Standard, Medium  
**COLORS:** All  
**CORE:** Lightweight Lead, KIARMOR Bi-Layer Low-Lead, KIARMOR Bi-Layer Lead-Free  
**CLOSURE:** Magnet

- Comfortable fit
- Large coverage area
- Optional monogram
- Optional KTC attachment



**TCV THYROID COLLAR WITH BINDING**

- SIZES:** X-Small, Standard, Medium
- COLORS:** Revolution 700 series & All Classic Nylon Colors
- CORE:** Lightweight Lead, KIARMOR Bi-Layer Low-Lead, KIARMOR Bi-Layer Lead-Free
- CLOSURE:** Hook and Loop Closure, Buckle or Magnet

- Comfortable fit
- Large protection area
- Optional monogram
- Optional KTC attachment



**TC SEWN-ON THYROID COLLAR**



- COLORS:** Classic Nylon Colors
- CORE:** Lightweight Lead, KIARMOR Bi-Layer Low-Lead, KIARMOR Bi-Layer Lead-Free

- Available on any apron, except aprons with overlapping front flaps, by adding "TC" to the apron part number.
- No need to search for your thyroid collar anymore. The TC, attached thyroid collar, offers superior protection while being conveniently attached to your protection apron.

**300102 THYROID COLLAR COVER**



- Keeps thyroid collars sanitary and clean
- Attaches easily to NST-S1 & TCV-S1 collars
- Easy to wash or replace when soiled
- Revolution 700 Series & All Classic Nylon Colors
- Can be monogrammed for personalization and easy identification

**KTC ATTACHMENT OPTIONS**



**KTC Buckle**



**KTC Key Ring**



**KTC No Buckle**



KTC attachment is now securely positioned on the shoulder of all Revolution aprons.



## PARTNERING TO KEEP YOUR APRONS CLEAN & SAFE

Infab is proud to be a global cleaning solutions partner with Clorox.



### Excellent product aesthetics

- No harsh chemical odor or fumes
- No fragrance added
- Nonflammable, unlike quaternary ammonium-alcohol-based wipes
- No volatile organic compounds (VOCs)

### Broad healthcare surface compatibility

- Recommended for plastics and laminated surfaces, whereas isopropyl alcohol will attack some forms of plastic, rubber and coatings\*
- Surface materials: All Infab aprons, stainless steel, vinyl, glass, baked enamel, chrome, glazed tile, glazed ceramic, glazed porcelain, porcelain enamel, laminated surfaces, plastic
- If light residue appears, it can easily be removed with a clean, damp cloth

Pictures of 1 ft<sup>2</sup> Infab apron surfaces after treated with 120 product applications over a 10-week period.

Clorox Healthcare® Hydrogen Peroxide Cleaner Disinfectant Wipes

			
Revolution Fabric	Cool Wear	Standard Nylon	Diamond Ripstop

\* Based on 30-second non-TB, non-Staphylococcus epidermidis bacteria and virus contact times for general disinfecting on federal master labels as of 2/14/13.



**683447**

**REVOLUTION  
SCRUBBLES  
APRON CLEANER**

Scrubbles apron cleaner safely cleans your aprons of barium, blood and other common radiology related stains. Now with a clean citrus scent and a stronger more efficient formula.

**SIZE** 32 oz

**683448**  
Case of 12 32 oz bottles with Spray Caps



**CLX28**

**CLOROX SPRAY**

Recommended for:  
Multipurpose use on hard and soft surfaces

**SIZE** 32 oz



**CLX29**

**CLOROX REFILL**

Recommended for:  
Multipurpose use on hard and soft surfaces

**SIZE** 128 oz



**CLX24**

**CLOROX  
MULTIPURPOSE  
WIPES**

Recommended for: Everyday cleaning and disinfecting, daily patient room cleaning, hard, high-touch surfaces

**SIZE** 6.75" x 9"

**QTY** 95 ct



**CLX26**

**CLOROX  
TERMINAL  
WIPES**

Recommended for: Terminal cleaning and disinfecting of hard surfaces

**SIZE** 12" x 11"

**QTY** 185 ct.



**CLX27**

**CLOROX  
TERMINAL  
WIPES REFILL**

Recommended for: Terminal cleaning and disinfecting of hard surfaces

**SIZE** 12" x 11"

**QTY** 185 ct.

**NSM NON-SLIP MATERIAL FOR SKIRTS**

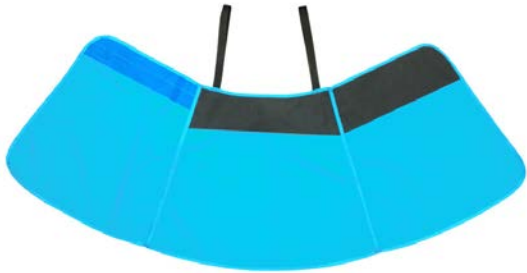

- Prevents your Infab skirt from slipping down the waist and causing discomfort
- Can be added to any Infab skirt by adding part number NSM

**SHIN GUARDS**



- Reduce radiation exposure to the shins
- Hook and loop closures for easy adjustments

**COLORS:** Classic Nylon Colors  
**SIZES:** Small, Medium, Large  
**CORE:** Lightweight Lead, KIARMOR Bi-Layer Low-Lead, KIARMOR Bi-Layer Lead-Free

**REV-BAG REVOLUTION APRON BAG**



- Revolution fabric
- Plastic bottom to prevent sagging
- Opening on top of bag
- Zipper across the top of bag



**909821 APRON BAG**



- Classic nylon color options
- Classic tube style design
- Opening on side of bag
- Plastic handle on top of bag



**REV-SLV-1** REVOLUTION ATTACHED THYROID COLLAR SLEEVES



- Exclusive Revolution outer fabric
- Additional protection for chest
- Wear under any apron

**COLORS:** Revolution 700 Series  
**SIZES:** Small, Medium, Large, X-Large, XX-Large  
**CORE:** Lightweight Lead, KIARMOR Bi-Layer Low-Lead, KIARMOR Bi-Layer Lead-Free



FRONT



BACK

**REV-SLV-2** REVOLUTION SLEEVE INDIVIDUAL



- Exclusive Revolution outer fabric
- Hook and loop closure elastic strap for easy on/off convenience
- One per order

**COLORS:** Revolution 700 Series  
**CORE:** Lightweight Lead, KIARMOR Bi-Layer Low-Lead, KIARMOR Bi-Layer Lead-Free





## APW AXILLARY PROTECTION WINGS

Increase the protection to your axillary region without sacrificing any mobility or adding weight to your apron.

**COLORS:** Revolution 700 Series & All Classic Nylon Colors  
**CORE:** Lightweight Lead, KIARMOR Bi-Layer Low-Lead, KIARMOR Bi-Layer Lead-Free



## SLV OPTIONAL LEFT OR RIGHT

- Added protection of the arm and shoulder
- .50mm LE
- Available on most Infab apron models
- Optional removable snap on, permanent sewn on or hook and loop closure attached configuration

**COLORS:** Revolution 700 Series & All Classic Nylon Colors  
**ATTACHED:** Sewn on, snaps or hook and loop closure  
**CORE:** Lightweight Lead, KIARMOR Bi-Layer Low-Lead, KIARMOR Bi-Layer Lead-Free



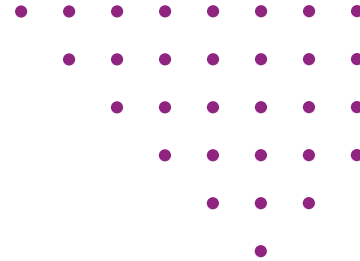

**THE ORIGINAL BLACK BELT®**

For extra support and weight relief. The Black Belt® is a 6" wide orthopedic elastic belt that supports your lower back while removing the weight of the apron from your shoulders. Optional KTC Buckle Attachment or side snaps.

**COLORS:** Black  
**SIZES:** X-Small, Small, Medium, Large, X-Large, XX-Large

- 257879** 6" Black Belt® - X-Small
- 257880** 6" Black Belt® - Small
- 257881** 6" Black Belt® - Medium
- 257882** 6" Black Belt® - Large
- 257883** 6" Black Belt® - X-Large
- 257884** 6" Black Belt® - XX-Large



**257890 SUSPENDERS**

Need a little help holding your radiation protection skirt in place? Now, exclusively from Infab, you can add these fully adjustable suspenders with a handy snap on style. One size fits all.



**REVOLUTION ELASTIC BACK THINKING CAP**

- Exclusive Revolution outer fabric
- Scatter radiation protection
- Cool Wear Moisture-Wicking Fabric
- Elastic-back for easy on/off convenience

**SIZE:** Small, Medium, Large, X-Large, XX-Large

**COLORS:** 700 Series Revolution Colors

**PROTECTION:** .25mm LE, .35mm LE, .50mm LE

**CORE:** Lightweight Lead, KIARMOR Bi-Layer Low-Lead, KIARMOR Bi-Layer Lead-Free



**400025 REVOLUTION HOOK AND LOOP CLOSURE BACK THINKING CAP**

- Exclusive Revolution outer fabric
- Scatter radiation protection
- Cool Wear Moisture-Wicking Fabric
- Hook & loop back closure for customizable fit

**SIZE:** One Size Fits All

**COLORS:** 700 Series Revolution Colors

**PROTECTION:** .25mm LE, .35mm LE, .50mm LE

**CORE:** Lightweight Lead, KIARMOR Bi-Layer Low-Lead, KIARMOR Bi-Layer Lead-Free



**CLASSIC THINKING CAP WITH TIE STRAPS**

- Head and Skull Radiation Protection
- Classic nylon color options
- .25mm LE, .35mm LE, .5mm LE
- Cool Wear Moisture-Wicking Fabric

**SIZE:** Small, Medium, Large, X-Large, XX-Large

**COLORS:** Classic Nylon Colors

**PROTECTION:** .25mm LE, .35mm LE, .50mm LE

**CORE:** Lightweight Lead, KIARMOR Bi-Layer Low-Lead, KIARMOR Bi-Layer Lead-Free

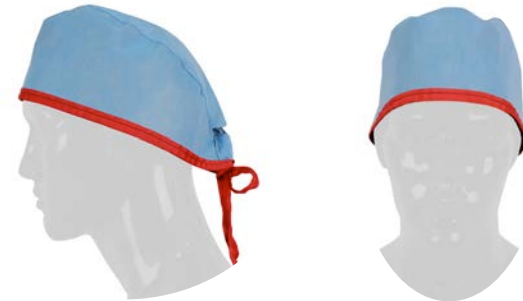

**DC-25 LEAD-FREE DISPOSABLE THINKING CAP**

- Quantity 20/Case
- .25mm LE
- Adjusts to fit all head sizes
- For use by all personnel during any interventional procedure
- 100% lead free for easy disposal

**SIZE:** One Size Fits All

**COLORS:** Scatter Armor Blue

**PROTECTION:** .25mm LE

**CORE:** KIARMOR Bi-Layer Lead-Free

CASSETTE COVERS

# Protect Your Cassettes

COMPLETE, HIGHLY EFFECTIVE PROTECTION FROM CONTAMINATION



8" x 10"



10" x 12"



14" x 17"



16" x 19"



24" x 20"

Infab offers our Cassette Covers in a variety of standard sizes to perfectly fit your needs.

Protect your cassettes in our simple and convenient Infab Cassette Covers.

Available in Boxes of 100 or Cases of 500 in an easy-to-use dispenser box.

Cassettes come in contact with blood and other potentially infectious materials.

- Protect your cassettes from cross-contamination
- Protect your patients from infection
- Specially designed to fit your X-ray cassettes
- For use in any imaging area where a risk of contamination exists.

IN-STOCK SAME-DAY SHIPPING

Help Stop the Spread of Infection



The Centers for Disease Control and Prevention (CDC) estimates that roughly 1.7 million hospital-associated infections, from all types of bacteria combined, cause or contribute to 99,000 deaths each year.<sup>1</sup>

<sup>1</sup> Klevens RM, Edwards JR, Richards CL, et al. (2007). "Estimating health care-associated infections and deaths in U.S. hospitals, 2002". Public Health Rep 122 (2): 160–6. PMID 17357358.

<sup>2</sup> Scott II, R. Douglas, (2009). "The Direct Medical Costs of Healthcare-Associated Infections in U.S. Hospitals and the Benefits of Prevention". National Center for Preparedness, Detection, and Control of Infectious Diseases

**ZIP TOP CASSETTE COVERS**

**BOX OF 100/500**



Zip Top



- Zip top
- Packed in handy dispenser boxes
- 100 or 500 individual covers per box
- Available in the five cassette sizes
- Always in stock
- Impervious to fluids
- Available in money saving cases of 500.
- Easy to use
- High quality
- Sanitary
- Disposable
- Top grade polyethylene plastic

Model	Description		Dimensions	Fits Cassette Size
910810-ZT	Cassette Cover Zip Top	Disposable Box of 100	11.25" x 13.25"	8" X 10"
900810-ZT	Cassette Cover Zip Top	Disposable Box of 500	11.25" x 13.25"	8" X 10"
911012-ZT	Cassette Cover Zip Top	Disposable Box of 100	13.375" x 14.75"	10" X 12"
901012-ZT	Cassette Cover Zip Top	Disposable Box of 500	13.375" x 14.75"	10" X 12"
911417-ZT	Cassette Cover Zip Top	Disposable Box of 100	17" x 19.875"	14" X 17"
901417-ZT	Cassette Cover Zip Top	Disposable Box of 500	17" x 19.875"	14" X 17"
911619-ZT	Cassette Cover Zip Top	Disposable Case of 100	19.25" x 22.25"	16" x 19"
901619-ZT	Cassette Cover Zip Top	Disposable Case of 500	19.25" x 22.25"	16" x 19"
912420-ZT	Cassette Cover Zip Top	Disposable Case of 100	20" x 24.625"	24" x 20"
902420-ZT	Cassette Cover Zip Top	Disposable Case of 500	20" x 24.625"	24" x 20"

**FLIP TOP CASSETTE COVERS**

**BOX OF 100/500**



Sandwich bag style flap

- "Sandwich" bag style flap
- Packed in handy dispenser boxes
- 100 or 500 individual covers per box
- Available in the five cassette sizes
- Always in stock
- Impervious to fluids
- Available in money saving cases of 500.
- Easy to use
- High quality
- Sanitary
- Disposable
- Top grade polyethylene plastic

Model	Description		Dimensions	Fits Cassette Size
910810	Cassette Cover	Disposable Box of 100	11.25" x 13.25"	8" X 10"
900810	Cassette Cover	Disposable Case of 500	11.25" x 13.25"	8" X 10"
911012	Cassette Cover	Disposable Box of 100	13.375" x 14.75"	10" X 12"
901012	Cassette Cover	Disposable Case of 500	13.375" x 14.75"	10" X 12"
911417	Cassette Cover	Disposable Box of 100	17" x 19.875"	14" X 17"
901417	Cassette Cover	Disposable Case of 500	17" x 19.875"	14" X 17"
911619	Cassette Cover	Disposable Box of 100	19.25" x 22.25"	16" x 19"
901619	Cassette Cover	Disposable Case of 500	19.25" x 22.25"	16" x 19"
912420	Cassette Cover	Disposable Case of 100	20" x 24.625"	24" x 20"
902420	Cassette Cover	Disposable Case of 500	20" x 24.625"	24" x 20"



**CASSETTE COVERS ROLL & RACK  
(AVAILABLE SEPARATELY)**

- Easy to use
- High quality
- Sanitary
- Disposable
- Top grade polyethylene plastic
- 500 individual covers per roll
- Always in stock
- Impervious to fluids
- Easy installation
- High quality

Fits up to 14" x 17" (35 x 43 cm) cassettes

Model	Description
900500	Roll of 500 Disposable Cassette Covers
900750	Wall Mounted rack for Cassette Cover Rolls

**CASSETTE COVER WALL MOUNTED RACK**

- Stores 100 covers at your fingertips
- Easy to use
- High quality
- Easy Installation

Model	Description
901825	Cassette Cover Wall Mounted rack for 14" x 17" covers
910829	Cassette Cover Wall Mounted rack for 8" x 10" covers
911132	Cassette Cover Wall Mounted rack for 10" x 12" covers

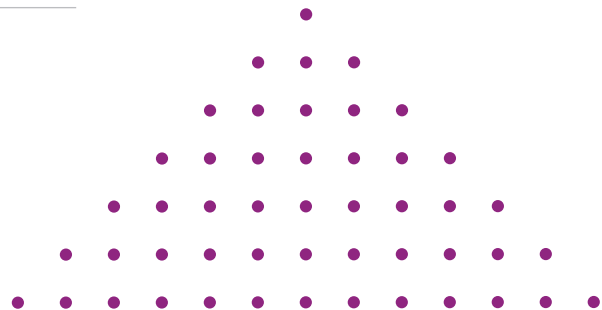

LABELS FOR ALL GLASSES



## GLASSES

Infab Corporation offers a complete array of lead glass eye protection and lead glass fitover frames. These attractive, stylish frames all meet the industry standard of 0.75mm lead equivalency radiation safety glass. Lead glass lenses provide protection from harmful radiation exposure.

### PRESCRIPTION

We offer plano, single vision, bifocal, and bifocal progressive options.

### FRAMES

Wide variety of frames from top designers for all face sizes.

### PROTECTION

All lead glasses have .75mm LE protection with the exception of the Flip Top model, Part #800275.

### NIKE FRAMES

Complete line of Nike frames, constantly updating. Check for availability.

### PERSONALIZATION

Add your name to your glasses frame.





**CURRENT-01**  
Matte Black

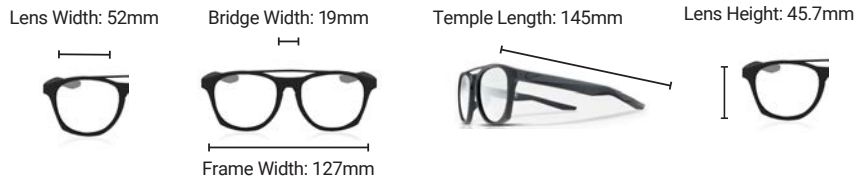

**NIKE CURRENT** SINGLE VISION, PLANO | 60.2G

Nike Current lead glasses combine everyday appeal with performance benefits. With a nod to the aviator style, they provide clear vision and a stable fit in a super-low profile frame.

<b>FRAME SIZE:</b>	Universal
<b>WEIGHT:</b>	60.2G
<b>PRESCRIPTION:</b>	Single Vision, Plano
<b>COLORS:</b>	Matte Black
<b>PROTECTION</b>	.75mm LE
<b>INCLUDES</b>	Anti-fog spray, safety strap add-on, protective case

**NIKE LEDGE** SINGLE VISION, PLANO | 65.1G

With a super-low profile and strong, squared off design, the Nike Ledge lead glasses provide style and comfort.

<b>FRAME SIZE:</b>	Universal
<b>WEIGHT:</b>	65.1G
<b>PRESCRIPTION:</b>	Single Vision, Plano
<b>COLORS:</b>	Matte Black
<b>PROTECTION</b>	.75mm LE
<b>INCLUDES</b>	Anti-fog spray, safety strap add-on, protective case



**LEDGE-01**  
Anthracite

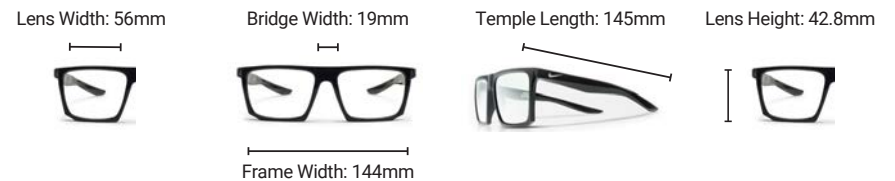





**TRAVERSE-02**  
Matte Anthracite

**TRAVERSE-01**  
Matte Black



Lens Width: 70mm

Bridge Width: 13mm

Temple Length: 135mm

Lens Height: 42mm



Frame Width: 133mm

## NIKE PREMIER

PLANO | 71.8G

Lightweight and comfortable, the Nike Premier lead glasses feature slimmed down temples with tips that grip for stability.

<b>FRAME SIZE:</b>	Universal
<b>WEIGHT:</b>	71.8
<b>PRESCRIPTION:</b>	Plano
<b>COLORS:</b>	Cool Grey, Matte Blue
<b>PROTECTION</b>	.75mm LE
<b>INCLUDES</b>	Anti-fog spray, safety strap add-on, protective case



**PREMIER-05**  
Matte Blue

**PREMIER-04**  
Cool Grey



Lens Width: 60mm

Bridge Width: 13mm

Temple Length: 135mm

Lens Height: 39.3mm



Frame Width: 145mm



**BANDIT-02**  
Blue



**BANDIT-01**  
Black



**BANDIT-03**  
White

**NIKE BANDIT** PLANO | 80G

The Nike Bandit is a full rim square frame which is made of plastic. It comes with nose pads that snap into the pad box. This product offers our standard high quality, distortion-free radiation-reducing lenses with .75mm lead equivalency.

- FRAME SIZE:** Large Frame
- WEIGHT:** 80G
- PRESCRIPTION:** Plano
- COLORS:** Blue, Black, White
- PROTECTION:** .75mm LE
- INCLUDES:** Anti-fog spray, safety strap add-on, protective case

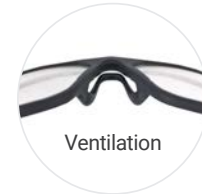

- Ventilated nose bridge for reduced fogging and secure grip
- Tiny holes in top of frame for air circulation and fog/moisture prevention

Bridge Width: 17mm    Temple Length: 145mm    Lens Width: 59mm    Lens Height: 45.1mm

**NIKE FLEET** PLANO | 71G

The Nike Fleet is a full rim square frame which is made of plastic. It comes with nose pads that snap into the pad box. This product offers our standard high quality, distortion-free radiation-reducing lenses with .75mm lead equivalency.

- FRAME SIZE:** Universal
- WEIGHT:** 71 G
- PRESCRIPTION:** Plano
- COLORS:** Matte Black/Volt, Matte Grey, Matte Blue/Grey
- PROTECTION:** .75mm LE
- INCLUDES:** Anti-fog spray, safety strap add-on, protective case

- Smaller version of Bandit

Bridge Width: 16mm    Temple Length: 135mm    Lens Width: 55mm    Lens Height: 42mm



**FLEET-01**  
Matte Black/Volt



**FLEET-02**  
Matte Grey



**FLEET-03**  
Matte Blue/Grey



**BRAZEN-02**  
Matte Black / Military Blue

**BRAZEN-04**  
Shiny Black



## NIKE BRAZEN

PLANO | 77G

The Nike Brazen glasses combine streamlined style, comfort and lightweight durability. They feature a nylon frame and ventilated nose bridge. The Brazen is our most popular model.

<b>FRAME SIZE:</b>	Universal
<b>WEIGHT:</b>	77G
<b>PRESCRIPTION:</b>	Plano
<b>COLORS:</b>	Matte Black/Military Blue, Shiny Black
<b>PROTECTION</b>	.75mm LE
<b>INCLUDES</b>	Anti-fog spray, safety strap add-on, protective case

Bridge Width: 16mm



Frame Width: 135mm



Lens Width: 60mm



Lens Width: 40mm



## NIKE LEGEND

PLANO | 85G

Combining performance eyewear with versatile style, the Nike Legend has a clean, lightweight design. .75mm LE Meets ANSI requirement for side shielding.

<b>FRAME SIZE:</b>	Universal
<b>WEIGHT:</b>	85 G
<b>PRESCRIPTION:</b>	Plano
<b>COLORS:</b>	Black/Volt, Matte Wolf Grey - Obsidian
<b>PROTECTION</b>	.75mm LE
<b>INCLUDES</b>	Anti-fog spray, safety strap add-on, protective case

Bridge Width: 15mm



Temple Length: 135mm



Lens Width: 65mm



Lens Height: 44mm



**LEGEND-01**  
Black/Volt

**LEGEND-02**  
Matte Wolf Grey - Obsidian





**7101-01**  
Matte Anthracite

**NIKE 7101** SINGLE VISION, PLANO | 58G

Nike 7101 is a full rim frame made of plastic. It features the Nike swoosh logo on temples. This product offers our standard high quality, distortion-free radiation reduction lenses.

- FRAME SIZE:** Universal
- WEIGHT:** 58G
- PRESCRIPTION:** Single Vision, Plano
- COLORS:** Matte Anthracite
- PROTECTION:** .75mm LE
- INCLUDES:** Anti-fog spray, safety strap add-on, protective case

Bridge Width: 15mm    Arm Width: 140mm    Lens Width: 53mm    Lens Height: 37mm



**NIKE 7102** SINGLE VISION, PLANO | 58G

Nike 7102 is a full rim frame made of plastic. It features the Nike swoosh logo on temples. This product offers our standard high quality, distortion-free radiation-reducing lenses.

- FRAME SIZE:** Universal
- WEIGHT:** 71 G
- PRESCRIPTION:** Single Vision, Plano
- COLORS:** Matte Seaweed, Matte Navy
- PROTECTION:** .75mm LE
- INCLUDES:** Anti-fog spray, safety strap add-on, protective case

Bridge Width: 15mm    Arm Width: 140mm    Lens Width: 55mm    Lens Height: 36mm



**7102-01**  
Matte Seaweed



**7102-02**  
Matte Navy





**7237-01**  
Matte Black-Dark Grey



**7238-04**  
Matte Black/Grey



**7238-05**  
Matte Grey/Blue

**NIKE 7237** SINGLE VISION, PLANO | 56G

<b>FRAME SIZE:</b>	Universal
<b>WEIGHT:</b>	56 G
<b>PRESCRIPTION:</b>	Single Vision, Plano
<b>COLORS:</b>	Matte Black/Dark Grey
<b>PROTECTION:</b>	.75mm LE
<b>INCLUDES:</b>	Anti-fog spray, safety strap add-on, protective case

- Lightweight acetate frame design for comfort and durability
- Stacked acetate temples with pop color accents in sneaker tread pattern
- Cam action hinges: snap firmly into place
- Jeweled plaque Nike Swoosh logo for pop color accent

Bridge Width: 17mm



Temple Length: 140mm



Lens Width: 52mm



Lens: 31mm



**NIKE 7238** SINGLE VISION, PLANO | 56G

<b>FRAME SIZE:</b>	Universal
<b>WEIGHT:</b>	58 G
<b>PRESCRIPTION:</b>	Single Vision, Plano
<b>COLORS:</b>	Matte Black/Grey, Matte Grey/Blue
<b>PROTECTION:</b>	.75mm LE
<b>INCLUDES:</b>	Anti-fog spray, safety strap add-on, protective case

- Lightweight acetate frame design for comfort and durability.
- Stacked acetate temples with pop color accents in tread pattern
- Cam action hinges snap firmly into place
- Jeweled plaque Nike Swoosh logo for pop color accent

Bridge Width: 18mm



Arm Width: 140mm



Lens Width: 52mm



Lens Width: 36.4mm





**FINESSE-01**  
Black



**NIKE FINESSE**

PLANO | 68G

- FRAME SIZE:** Female
- WEIGHT:** 68 G
- PRESCRIPTION:** Plano
- COLORS:** Black, Matte Grey
- PROTECTION:** .75mm LE
- INCLUDES:** Anti-fog spray, safety strap add-on, protective case

- Female
- Lightweight, durable nylon frame
- 6-base frame offers everyday coverage
- Durable, high tension hinges

Bridge Width: 15mm



Temple Length: 130mm



Lens Width: 58mm



Lens Height: 40mm



**FINESSE-02**  
Matte Grey

**NIKE SPREE**

PLANO | 77G

- Lightweight, durable nylon frame
- 6-base frame offers everyday coverage
- Durable, high tension hinges
- .75mm LE

<b>FRAME SIZE:</b>	Universal
<b>WEIGHT:</b>	77 G
<b>PRESCRIPTION:</b>	Plano
<b>COLORS:</b>	Matte Black, Matte Red
<b>PROTECTION</b>	.75mm LE
<b>INCLUDES:</b>	Anti-fog spray, safety strap add-on, protective case

Bridge Width: 18mm    Temple Length: 145mm    Lens Width: 57mm    Lens Height: 44mm



**SPREE-01**  
Matte Black



**SPREE-02**  
Matte Red



**UNREST-02**  
Wolf Grey - Deep Pewter

**NIKE UNREST**

PLANO | 72G

The Nike Unrest features a nylon frame for visual clarity and lightweight comfort.

<b>FRAME SIZE:</b>	Universal
<b>WEIGHT:</b>	72 G
<b>PRESCRIPTION:</b>	Plano
<b>COLORS:</b>	Wolf Grey - Deep Pewter
<b>PROTECTION</b>	.75mm LE
<b>INCLUDES:</b>	Anti-fog spray, safety strap add-on, protective case

Bridge: 19mm



Temple Length: 145mm



Lens: 57mm



Lens: 46mm



**INCREDIBLES**

PLANO | 75G

The Incredibles are a stylish wrap around safety frame made of TR-90 high impact resistant plastic. ANSI Z87.1+ approved, lightweight and comfortable. Includes a high quality carrying case. Incredibles glasses are .75mm LE and available from stock in non-prescription.

**FRAME SIZE:** Universal

**WEIGHT:** 75 G

**PRESCRIPTION:** Plano

**COLORS:** Soft Matte Black, Blue - Yellow, Grey Carbon, Red, Silver - Purple, Silver, Pink

**PROTECTION** .75mm LE

**INCLUDES:** Anti-fog spray, safety strap add-on, protective case

- Available in 7 colors
- Lens sizes: 62mm
- Lightweight acrylic frames
- Comfortable to wear
- Padded ear temple bars

Lens Width: 62 mm

Bridge Width: 18mm

Temple Length: 145mm



Lens Height: 36mm

Lens Diameter: 60mm

Frame Width: 130mm



**800064** Soft Matte Black



**860002** Blue - Yellow



**800068** Grey Carbon



**800066** Red



**683260** Silver



**880015** Pink



**860003** Silver - Purple





830250 Black



830251 Red



830252 Silver



800070 Blue

Lens Width: 62mm Bridge Width: 18mm Temple Length: 145mm Lens Height: 36mm Frame Width: 130mm



**MAXX 30**

PLANO, SINGLE VISION, BIFOCAL PROGRESSIVE | 63G

- FRAME SIZE:** Universal
- WEIGHT:** 63 G
- PRESCRIPTION:** Plano, Single Vision, Bifocal, Bifocal Progressive
- COLORS:** Black, Red, Silver, Blue
- PROTECTION:** .75mm LE
- INCLUDES:** Anti-fog spray, safety strap add-on, protective case

- Prescription compatible (for most Rx)
- First protective eyewear to receive the American Ophthalmology Associations seal of acceptance.
- Meets ANSI Z87.1+ standards along with ASTM F803 impact resistance standards.
- Temple bars and nose bridge have soft rubberized padding for extra comfort
- Lightweight and comfortable
- Large lens area for maximum protection
- Bifocal Progressive Rx frame (requires segment height)

**EDGE**

PLANO | 73G

- FRAME SIZE:** Universal
- WEIGHT:** 73 G
- PRESCRIPTION:** Plano
- COLORS:** Black, Silver
- PROTECTION:** .75mm LE
- INCLUDES:** Anti-fog spray, safety strap add-on, protective case

- Wrap around design for enhanced lateral protection
- Rubberized nose piece for comfort

Lens Width: 53mm Bridge Width: 17mm Temple Length: 130mm Lens Height: 35mm

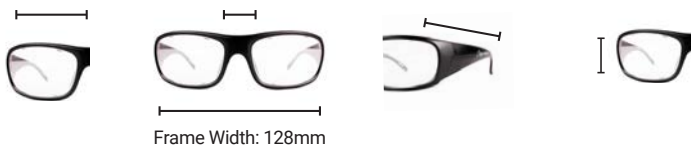

880005 Black



880006 Silver



870001 Silver



870002 Red



870003 Black

## XERXES

PLANO | 71G

<b>FRAME SIZE:</b>	Universal
<b>WEIGHT:</b>	71 G
<b>PRESCRIPTION:</b>	Plano
<b>COLORS:</b>	Shiny Black
<b>PROTECTION</b>	.75mm LE
<b>INCLUDES:</b>	Anti-fog spray, safety strap add-on, protective case

- Wrap-around shape that delivers more protection from radiation with nose pads for added comfort.
- Lightweight and comfortable
- Large lens area for maximum protection
- Non Rx

## ZONE

PLANO | 75G

<b>FRAME SIZE:</b>	Universal
<b>WEIGHT:</b>	75 G
<b>PRESCRIPTION:</b>	Plano
<b>COLORS:</b>	Silver, Red, Black
<b>PROTECTION:</b>	.75mm LE
<b>INCLUDES:</b>	Anti-fog spray, safety strap add-on, protective case

- Rubber nose pads and rubberized temple bars
- Wrap around design
- Lightweight and comfortable
- Large lens area for maximum protection

Lens Width: 60mm	Bridge Width: 18mm	Temple Length: 135mm	Lens Height: 36mm
Frame Width: 130mm			



800081 Shiny Black

Lens Width: 59mm	Bridge Width: 18mm	Temple Length: 140mm	Lens Height: 34mm
Frame Width: 129mm			

**ACHILLES**

PLANO, SINGLE VISION, BIFOCAL PROGRESSIVE | 69G



800076 Blue

<b>FRAME SIZE:</b>	Larger
<b>WEIGHT:</b>	69 G
<b>PRESCRIPTION:</b>	Plano, Single Vision , Bifocal, Bifocal Progressive
<b>COLORS:</b>	Blue, Red, Plated Silver, Shiny Black
<b>PROTECTION</b>	.75 mm LE
<b>INCLUDES:</b>	Anti-fog spray, safety strap add-on, protective case

- Vented radiation protection goggle with neoprene foam on the inside designed to protect against fluid splashing and perspiration
- Easy to adjust with elastic head band
- Prescription compatible (for most Rx)
- Lightweight and comfortable
- Large lens area for maximum protection



800075 Red



800077 Plated Silver



800079 Shiny Black

Lens Width: 53mm

Bridge Width: 17mm

Lens Height: 35mm

Frame Width: 128mm

**FLIP TOP**

PLANO | 85G

<b>FRAME SIZE:</b>	Universal
<b>WEIGHT:</b>	85 G
<b>PRESCRIPTION:</b>	Plano
<b>COLORS:</b>	Amber
<b>PROTECTION:</b>	.07mm LE
<b>INCLUDES:</b>	Anti-fog spray, safety strap add-on, protective case

- “Flip Top” radiation goggles are an all new product, designed to reduce scatter radiation by as much as 70% (actual reduction is dependent upon imaging technique used)
- Lightweight
- Large protective area (lens area 2.5” (6 cm) tall x 6.25 (16 cm) long)
- Flips open when not needed.
- Adjustable nose bridge
- Can be used as a stand alone radiation reduction goggle or fits easily over your existing glasses.



800275 Flip Top

Lens Height: 35mm

Frame Width: 128mm





683206 Clear/Blue

Lens Width: 59mm

Bridge Width: 19mm

Temple Length: 135-150mm

Lens Height: 40mm



Frame Width: 136mm

**DYLAN**

SINGLE VISION, PLANO | 60G

<b>FRAME SIZE:</b>	Universal	• Classic style
<b>WEIGHT:</b>	60 G	• Holds single vision prescriptions
<b>PRESCRIPTION:</b>	Single Vision, Plano	• Lightweight and comfortable
<b>COLORS:</b>	Black	
<b>PROTECTION</b>	.75mm LE	
<b>INCLUDES:</b>	Anti-fog spray, safety strap add-on, protective case	

**CYBERFLEX**

SINGLE VISION, PLANO | 83G

<b>FRAME SIZE:</b>	Universal	• Optional .50mm LE side shields
<b>WEIGHT:</b>	83 G	• Adjustable temple bar
<b>PRESCRIPTION:</b>	Single Vision, Plano	• Large viewing area
<b>COLORS:</b>	Clear/Blue	• Built-in side shields for added splash protection
<b>PROTECTION</b>	.75mm LE	• Oversized protective lens area
<b>INCLUDES:</b>	Anti-fog spray, safety strap add-on, protective case	• Splash protection



880001 Black

Lens Width: 50mm

Bridge Width: 24mm

Temple Length: 130mm

Lens Height: 42mm



Frame Width: 140mm



683213 Tortoise Shell

Lens Width: 57mm

Bridge Width: 9mm

Temple Length: 140mm

Lens Height: 59mm



Frame Width: 130mm

**PREMIUM WRAPS**

SINGLE VISION, PLANO | 90G

<b>FRAME SIZE:</b>	Universal	• Only radiation protection frames on the market with lead glass lenses on the side shields for superior protection and excellent front and peripheral vision.
<b>WEIGHT:</b>	90 G	• Spring hinges, formable side temple bars and a fully adjustable nose piece
<b>PRESCRIPTION:</b>	Single Vision, Plano	• Large front lens area is ideal for regular prescriptions.
<b>COLORS:</b>	Clear/Blue	• Prescription compatible (for most Rx)
<b>PROTECTION</b>	.75mm LE	• Lightweight and comfortable
<b>INCLUDES:</b>	Anti-fog spray, safety strap add-on, protective case	• Large lens area for maximum protection



800230 Matte Black



800240 Gun Metal



800235 Olive/Charcoal

**FITOVERS RAZOR**

PLANO | 82G

- FRAME SIZE:** Universal
- WEIGHT:** 82 G
- PRESCRIPTION:** Plano
- COLORS:** Matte Black, Gun Metal, Olive/Charcoal
- PROTECTION:** .75mm LE
- INCLUDES:** Anti-fog spray, safety strap add-on, protective case

- Fits frames not exceeding 132mm width x 38mm height.
- Wrap around Radiation protection
- Hypo-allergenic Crystal Nylon™ Frame
- Designed to be worn over small, square, or rectangle prescription eyewear frame shapes



800304 Matte Black



800306 Smoke Marble



800307 Claret Stripe

**FITOVERS LOTUS**

PLANO | 83G

- FRAME SIZE:** Universal
- WEIGHT:** 83 G
- PRESCRIPTION:** Plano
- COLORS:** Matte Black, Smoke Marble, Claret Stripe
- PROTECTION:** .75mm LE
- INCLUDES:** Anti-fog spray, safety strap add-on, protective case

- Fits frames not exceeding 141mm width x 40mm height.
- Wrap around Radiation protection
- Hypo-allergenic Crystal Nylon™ Frame
- Designed to be worn over medium, oval, or round prescription eyewear frame shapes



ORION-01 Black



ORION-02 Blue Marble

**FITOVERS ORION**

PLANO | 84G

- FRAME SIZE:** Universal
- WEIGHT:** 84 G
- PRESCRIPTION:** Plano
- COLORS:** Black, Blue Marble
- PROTECTION:** .75mm LE
- INCLUDES:** Anti-fog spray, safety strap add-on, protective case

- Fits frames not exceeding 140mm width x 43mm height.
- Wrap around Radiation protection
- Hypo-allergenic Crystal Nylon™ Frame
- Designed to be worn over medium prescription eyewear frame shapes
- Non Rx



832001 Tortoise



832000 Black

**FITOVERS ECOFIT**

PLANO | 90G

- FRAME SIZE:** Universal
- WEIGHT:** 90 G
- PRESCRIPTION:** Plano
- COLORS:** Black, Tortoise
- PROTECTION:** .75mm LE
- INCLUDES:** Anti-fog spray, safety strap add-on, protective case

- Wrap around Radiation protection
- .35mm LE side shield protection
- Hypo-allergenic Crystal Nylon™ Frame
- Designed to be worn over prescription eyewear



## GLOVES

Infab gloves are available in a wide variety of styles, sizes and protection levels.

### PROTECTION

Wide array of protection types based on usage.

### DISPOSABLE OPTIONS

Infab offers our customers a wide selection of sterile, disposable, radiation protection gloves.

### EVERYDAY USE

Infab offers high quality, affordable, multi-use gloves. Taking full advantage of years of Infab innovation, our line of gloves offer the highest quality materials you have come to expect from Infab Corporation.

### MITTENS & HAND SHIELDS

Offering users mobility and dexterity during their procedures. Hands and fingers move freely while the beam is blocked from the top.

## REVOLUTION GLOVES

Infab's Exclusive Revolution Radiation Protection gloves are designed to be the most comfortable, flexible, lightweight and protective gloves. Revolution Radiation Protection Gloves come with tactile grip finger tips. The tactile grip helps with keeping a strong grasp on instruments during a long procedure.

**SIZES:** 6.5, 7, 7.5, 8, 8.5, 9  
**COLORS:** Black  
**ATTENUATION**  
 Light (60kV:40%, 80kV:35%, 100kV:30%)  
 Medium (60kV:68%, 80kV:61%, 100kV:54%)  
 Heavy (60kV:75%, 80kV:69%, 100kV:63%)

- Latex-free
- Powder-free
- Tactile grip
- Tactile sensitivity
- Sterile
- Leaded rubber
- Anatomical fit
- Boxes of 5 available with each model (add -B to part number)



## LATEX-FREE LEAD-FREE NEOPRENE RADIATION PROTECTION GLOVES

Designed to reduce the amount of scattered radiation exposure to the hands from the primary X-ray beam during radiological procedures.

**SIZES:** 6.5, 7, 7.5, 8, 8.5, 9  
**ATTENUATION:** 60kVp:44.9%, 80kVp:36.3%, 100kVp:30.6%, 120kVp 26.8%  
 Direct beam energy levels. May vary by + 5%

- Lead-free
- Latex-free
- Powder-free
- High sensitivity
- 30% reduction of direct beam radiation transmitted at 100 kVp
- Packed in sterile pouch
- Shipped from stock





**683300-500**  
Black

**683300-501**  
Red/Black

**683300-503**  
Taupe/Black

**683300-505**  
Navy/Black

**683300-506**  
Teal/Black

### REVOLUTION MAXI-FLEX 5 FINGER LEAD GLOVES

The perfect way to insure your hands and lower forearms are fully protected by the most flexible, comfortable radiation protection gloves on the market. Comfortable fit with maximum dexterity. Soft removable, washable and replaceable inner liners that reduce odors and permit frequent laundering. Expanded durable vinyl outer covers are removable for inspection of lead core and permit replacement when they become worn. The lead vinyl cores are precision molded for consistent 0.50mm lead equivalency and long life.

- SIZES:** 15"
- COLORS:** Revolution Colors
- PROTECTION:** .50mm LE
- ACCESSORIES:** 683306 - Liners  
683307 - Covers

- .50mm LE
- Tough, durable vinyl outer coverings
- Soft, Flexible and Comfortable
- Removable, washable and replaceable Cool Wear moisture-wicking inner liners
- Replaceable outer covers

### MAXI-FLEX LEAD GLOVES

Comfortable fit with maximum dexterity. Soft removable, washable and replaceable inner liners reduce odors and permit frequent laundering. Expanded durable vinyl outer covers are removable for inspection of lead core and permit replacement when they become worn. The lead vinyl cores are precision molded for consistent 0.50mm lead equivalency and long life.

- SIZE:** 15"
- COLORS:** Grey, Blue
- PROTECTION:** .50mm LE
- ACCESSORIES:** 683306 Liners  
683307-108 Blue Covers  
683307-112 Grey Covers

- .50mm LE
- Removable, washable and replaceable Cool Wear moisture-wicking inner liners
- Tough, durable vinyl outer coverings
- Soft, Flexible and Comfortable
- Replaceable outer covers



**683300-112**  
Grey



**683300-108**  
Blue



## SPLIT PALM MITTENS

- Outstanding manual dexterity
- Slotted palm allowing the fingers to be extended from the mitten
- Complete hand and lower arm protection
- .50mm LE
- Fifteen inches in length
- Colors: Grey, Blue
- Removable, washable and replaceable Cool Wear moisture-wicking inner liners

**683700** Open palm mittens

**683701** Right Hand Open Palm Mitten

**683702** Left Hand Open Palm Mitten



## SPLIT PALM MITTENS WITH FLAP

- Special flap to close the opening in the mitten when finger extension is not desired
- .50mm LE
- Fifteen inches in length
- Colors: Grey, Blue
- Removable, washable and replaceable Cool Wear moisture-wicking inner liners

**683710** Open Palm Mittens with Flap

**683711** Right Hand Open Palm Mitten with Flap

**683712** Left Hand Open Palm Mitten with Flap



## HAND SHIELDS

- .50mm LE
- Durable, comfortable and fully adjustable
- Full upper hand protection
- Total mobility of the hand and fingers
- Finger retainers are constructed of durable 1" polypropylene webbing
- Hook and loop closure at wrist offers plenty of adjustment
- One size fits all

**684000** Hand Shields



## MAXI-FLEX MITTENS

The perfect way to insure your hands and lower forearms are fully protected by the most flexible, comfortable radiation protection mitten on the market.

- .50mm LE
- Removable, washable and replaceable Cool Wear moisture-wicking inner liners
- Soft, Flexible and Comfortable
- Colors: Grey, Blue
- Removable, washable and replaceable inner liners
- Replaceable outer covers

**683303** Maxi-Flex Mittens

**683308** Maxi-Flex Mitten Replacement Liners

**683309** Maxi-Flex Mitten Outer Covers



# SCATTER RADIATION SAFETY FOR THE INTERVENTIONALIST & TECH

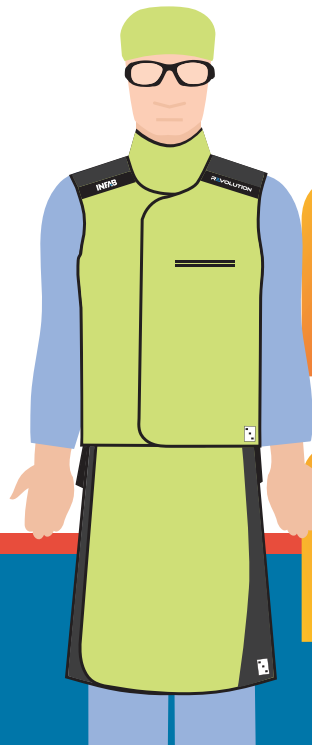

## Chest exposure

SCATTER ARMOR  
Reduces Chest Exposure  
**55-80%**

## Hand exposure

SCATTER ARMOR  
Reduces Hand Exposure  
**>49%**



**SCATTER ARMOR**



**Reduce Scatter Radiation Dose Exposure with Disposable Shields & Drapes**

**SCATTER ARMOR**  
Protective Core Material Inside:

**KI**  
KIARMOR  
BI-LAYER  
LEAD-FREE

The only bi-layer lead-free core material which passes DIN (6875-1), ASTM (F3094-14) and IEC (61331-1-2014) standards from 50 to 150 kVp.



*"The scattered radiation from the patient comprises the main source of radiation dose to staff."*

### Scatter Protection

Shields provide scatter radiation protection for radial and many other types of procedures. KIARMOR Bi-Layer is the most protective core material against scatter radiation.

### How it works

Sterile Scatter Armor Shields are placed on top of the patient drape to block scatter radiation at the source, creating a scatter-free zone, reducing harmful radiation exposure to the doctor or clinician.

### One-time use

Scatter Armor Shields are lead-free and disposable.

### Sterile

Packaged individually in sterile packets.

### Flexible

Scatter Armor Shields easily mold to the patients body for ease of use and maximum protection

### Scatter Radiation Testing

According to ASTM Test Method F3094-14.

Sample Information	50 kV	70 kV	90 kV	110 kV	120 kV	150 kV
Scatter Armor Shield	98.7%	96.1%W	92.0%	87.8%	85.8%	80.1%

### Direct Beam Attenuation

Sample Information	60 kV	80 kV	100 kV	120 kV
Scatter Armor Shield	0.967	0.911	0.846	0.788

### Absorbent

Scatter Armor Shields utilize the highest absorbency covering material in the industry, critical in heavy fluid situations.

Absorbent Rate	1.3 sec
Weight	2.36 osy / 80 gsm
Absorbent Capacity	686% 16.2osy / 549 gsm

GSM - Grams per square meter, OSY - Ounce per square yard

### Scatter Armor Multipurpose Shield

Transradial Access: Left and Right Radial, Shunt, Biliary Drainage, Spinal, Fibroid Embolization

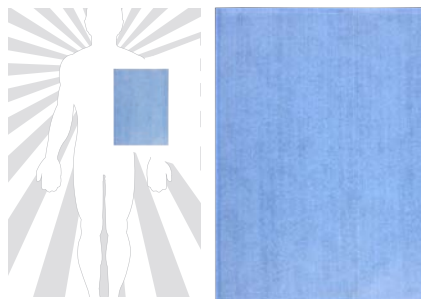

### Scatter Armor Angiography Shield

Transfemoral Access: Angiography, Coronary Catheterization

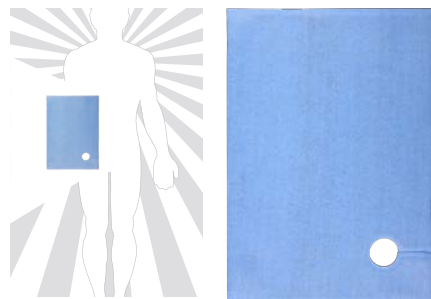

### Scatter Armor Biliary Split Shield

Biopsy Procedures, Transjugular Intrahepatic Portosystemic Shunt (TIPS)

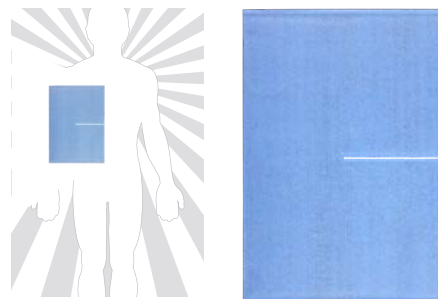

### Scatter Armor Peripheral Shield

Peripheral procedures where the access is through the femoral artery.

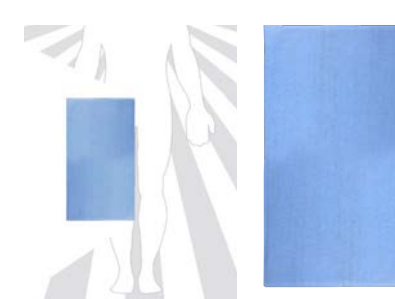

### Scatter Armor Multipurpose Shield with Fenestration

Needle Biopsy or Puncture Procedures.

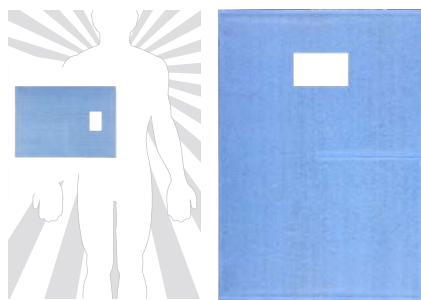

### Scatter Armor EP Shield

Subclavian Access: Bi-Ventricular Pacemaker Implants, ICS procedures, and Bi-Ventricular Pacing.

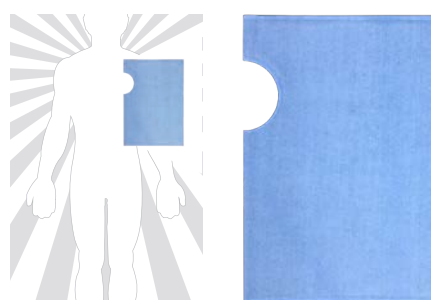

### Scatter Armor Dialysis Drape

Dialysis Access and Declothing Procedures.

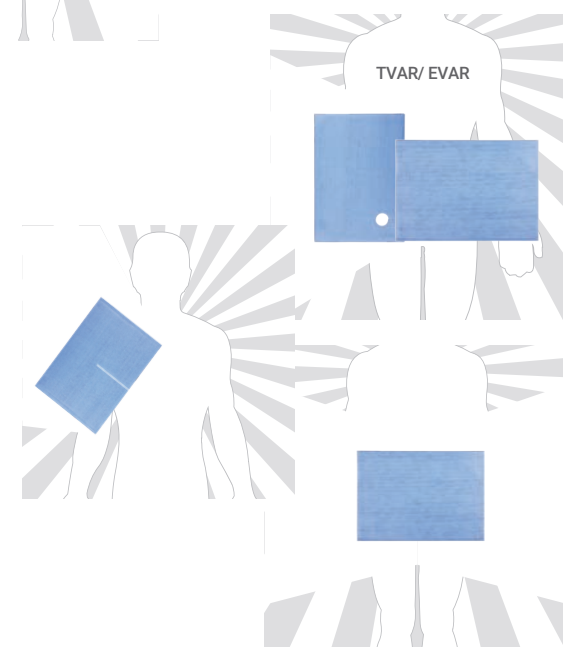
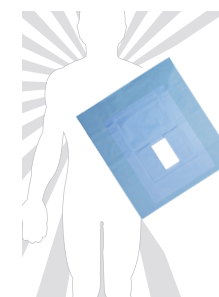
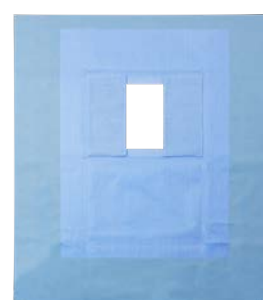

#### Scatter Armor Shields

Scatter Armor Multi-Purpose Shield, Absorbent, No Fenestration Box	SA-MPS	Box of 15
Scatter Armor Multi-Purpose Shield, Absorbent, No Fenestration Case	SA-MPS-CS	Case of 45
Scatter Armor Multi-Purpose Shield with Fenestration, Absorbent, Rectangular Fenestration Box	SA-MPF	Box of 15
Scatter Armor Multi-Purpose Shield with Fenestration, Absorbent, Rectangular Fenestration Case	SA-MPF-CS	Case of 45
Scatter Armor EP Shield, Absorbent, Scoop Fenestration Box	SA-EPS	Box of 15
Scatter Armor EP Shield, Absorbent, Scoop Fenestration Case	SA-EPS-CS	Case of 45
Scatter Armor Angiography Shield, Absorbent, Circular Fenestration Box	SA-AGS	Box of 15
Scatter Armor Angiography Shield, Absorbent, Circular Fenestration Case	SA-AGS-CS	Case of 45
Scatter Armor Biliary Split Shield, Absorbent, Center Slit Fenestration Box	SA-BSS	Box of 15
Scatter Armor Biliary Split Shield, Absorbent, Center Slit Fenestration Case	SA-BSS-CS	Case of 45
Scatter Armor Dialysis Drapes Box	SA-DDD	Box of 10
Scatter Armor Dialysis Drapes Case	SA-DDD-CS	Case of 30
Scatter Armor Peripheral Shield, Absorbent, No Fenestration Box	SA-PER	Box of 10
Scatter Armor Peripheral Shield, Absorbent, No Fenestration Case	SA-PER-CS	Case of 30

#### Part Number

#### Unit

SA-MPS	Box of 15
SA-MPS-CS	Case of 45
SA-MPF	Box of 15
SA-MPF-CS	Case of 45
SA-EPS	Box of 15
SA-EPS-CS	Case of 45
SA-AGS	Box of 15
SA-AGS-CS	Case of 45
SA-BSS	Box of 15
SA-BSS-CS	Case of 45
SA-DDD	Box of 10
SA-DDD-CS	Case of 30
SA-PER	Box of 10
SA-PER-CS	Case of 30

## BARRIERS

Infab high-quality radiation protection barriers are purpose-built to handle the daily rigors of hospital use. These smooth-rolling and easy-maneuvering barriers offer the highest levels of radiation protection in the industry.

### WINDOW

Your choice of 2.0mm LE lead glass, completely encased with acrylic panels to help prevent damage and breakage, or .50mm LE acrylic

### CASTERS

Hospital-grade swivel locking casters, for easy mobility and positive and secure placement.

### FRAME

Powder coated steel frame. Precision TIG welded for years of trouble-free service completely enclosing the leaded glass panel for increased durability and safety

### PROTECTION

2.0mm LE lead glass or .50mm LE acrylic window  
1.5mm LE base panel  
2 0.75mm LE Curtains totalling 1.5mm LE

### COLORS

Standard white, black or grey. Custom options available. Upcharge applies.

### CUSTOMIZATION

- Color: Frames can be custom powder coated in any pantone color (upcharge applies)
- Size: Infab can produce barriers to your specification
- Logo: Add your logo to any barrier
- Stainless Steel: Optional stainless steel frame



Stationary floor and wall-mounted barriers, built to your specifications.





## 683462 TILTED BARRIER WITH REACH-THROUGH CURTAIN

<b>WINDOW:</b>	<b>2.0mm LE Lead Glass or .50mm LE Acrylic</b>
<b>WINDOW SIZE:</b>	24" H x 30" W
<b>OVERALL SIZE:</b>	70" H x 34" W X 25" D
<b>CURTAIN SIZE:</b>	20" H x 30" W
<b>COLORS:</b>	Standard white, grey or black. Custom options available.
<b>FRAME:</b>	Metal, Stainless Steel (Upgrade)
<b>SHIPPING:</b>	Crate: 73" x 30" x 43", 355 lbs / 161.03 kg

- Tilted design for better view
- Powder coated steel frame
- Acrylic impact panels, enclosed in a precision TIG welded frame for years of trouble-free service, completely enclosing the leaded glass panel for increased durability and safety
- 2 high-quality hospital grade locking casters
- 1.50mm LE opaque base covered in "Sintra" plastic for easy cleaning and durability
- Modular parts can be easily replaced, including the glass if needed.
- Ergonomical viewing area
- Shipping worldwide by ground, air or sea freight



REACH-THROUGH CURTAIN



**076994 PHYSICIAN PROTECTION MOBILE SCREEN**

A unique new design for operating physicians that allows unparalleled protection for close-to-table studies. Sturdy, yet thoughtfully engineered with a small footprint so it can easily be positioned exactly where you want it for maximum scatter radiation protection.

- WINDOW:** .50mm LE acrylic
- WINDOW SIZE:** 45.7" W x 18.7" Height
- OVERALL SIZE:** Minimum Height: 57.5" (146 cm), Maximum Height: 69.7" (177 cm)  
Base: 27" W x 24" D
- FRAME COLORS:** Standard white, grey or black. Custom options available.
- CURTAIN COLORS:** Standard Revolution grey. Custom options available.
- FRAME:** Metal, Stainless Steel (Upgrade)
- SHIPPING:** Pallet: 48" x 40" x 12", 160 lbs / 72.57 kg

- Screen height adjustable by 11.8" (30 cm). Includes safety catch to set in desired position
- .50mm LE double protective curtain
- Horizontal position can be adjusted to fit close to table
- 2 high-quality hospital grade locking casters
- Powder coated steel frame
- Modular parts can be easily replaced, including the lead acrylic if needed.
- Shipping worldwide by ground, air or sea freight



**076994-IT**  
Optional 9"x 24" Stainless Steel Instrument Tray





## REV-PMC REVOLUTION MOBILE CURTAIN

A unique new design for operating physicians that allows unparalleled protection for close-to-table studies. Sturdy, yet thoughtfully engineered with a small footprint so it can easily be positioned exactly where you want it for maximum scatter radiation protection.

<b>SIZE:</b>	Adjustable height 43½" - 66" Base: 34" W x 25" D
<b>CURTAIN:</b>	38"H x 30"W .50mm LE lead curtain with grey Revolution fabric
<b>FRAME COLORS:</b>	Standard white, grey or black. Custom options available.
<b>CURTAIN COLORS:</b>	Standard Revolution grey. Custom options available.
<b>FRAME:</b>	Powder Coated Steel, Stainless Steel (Upgrade)
<b>SHIPPING:</b>	Box: 13" x 42" x 9", 45 lbs / 20.41 kg Box: 26" x 30" x 8", 30 lbs / 13.60 kg



- Special 4 caster T-bar base design to stabilize the unit
- Smooth easy maneuvering
- Special spring mechanism allows for easy raising, lowering, and automatically holding shield
- .50mm LE double protective curtain
- 2 high-quality hospital grade locking casters

Spring mechanism makes it easy to raise and lower and stay in place.



**REV-SPMC** REVOLUTION SOLID PANEL MOBILE CURTAIN

- SIZE:** 56" H x 30" W
- CURTAIN:** 30" x 30"
- PROTECTION:** REV-SPMC10 1.0mm LE  
REV-SPMC50 .50mm LE
- FRAME COLORS:** Standard white, grey or black. Custom options available.
- CURTAIN COLORS:** Standard Revolution grey. Custom options available.
- FRAME:** Powder Coated Steel, Stainless Steel (Upgrade)
- SHIPPING:** Box: 21" x 21" x 10", 18 lbs / 8.17 kg  
Box: 16" x 33" x 7", 28 lbs / 12.7 kg

- Heavy-duty hospital-grade purpose-built unit.
- Adjustable height between 37" and 56"
- 30" wide by 30" tall lead vinyl curtain
- 2 high-quality hospital grade locking casters
- Smooth and easy maneuvering



Adjustable height locking system from 37" to 56"







## REV-MC ECONOMY MOBILE CURTAIN

<b>SIZE:</b>	66" H x 28" W
<b>CURTAIN:</b>	30" x 30" .50mm LE curtain with grey Revolution fabric
<b>FRAME COLORS:</b>	Standard white, grey or black. Custom options available.
<b>CURTAIN COLORS:</b>	Standard Revolution grey. Custom options available.
<b>FRAME:</b>	Powder Coated Steel, Stainless Steel (Upgrade)
<b>SHIPPING:</b>	Box: 24" x 30" x 12", 20 lbs / 9.07 kg Box: 6" x 6" x 6", 27 lbs / 12.25 kg

- Raise and lower shield
- Smooth easy maneuvering
- Special spring mechanism allows for easy raising, lowering, and automatically holding shield
- .50mm LE double protective curtain
- 2 high-quality hospital grade locking casters



**KIARMOR**  
BI-LAYER  
INSIDE



**683461 TILTED MOBILE BARRIER**

**WINDOW:** 2.0mm LE Lead Glass or .50mm LE Acrylic  
**WINDOW SIZE:** 24" H x 30" W  
**OVERALL SIZE:** 70" H x 34 1/4" W X 25" D  
**COLORS:** Standard white, grey or black. Custom options available.  
**FRAME:** Metal, Stainless Steel (Upgrade)  
**SHIPPING:** Crate: 73" x 30" x 43", 355 lbs / 161.03 kg

- Powder coated steel frame
- Acrylic impact panels, enclosed in a precision TIG welded frame for years of trouble-free service, completely enclosing the leaded glass panel for increased durability and safety
- 2 high-quality hospital grade locking casters
- 1.50mm LE opaque base covered in "Sintra" plastic for easy cleaning and durability
- Modular parts can be easily replaced, including the glass if needed.
- Ergonomical viewing area
- Shipping worldwide by ground, air or sea freight

Tilted design for better view

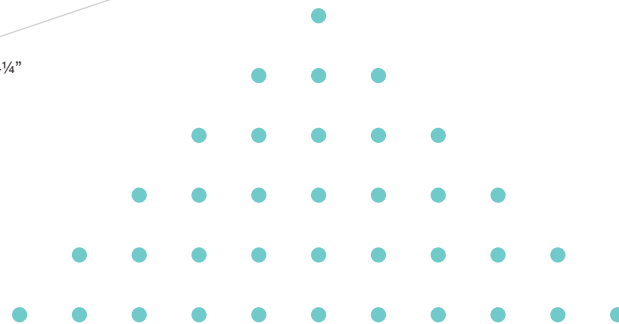



## 076993 TECHNICIAN PROTECTION MOBILE SCREEN

The Technician Protection Mobile Screen can be easily raised and lowered by hand and stays in position thanks to the perfectly counter-balanced internal springs. The high quality steel construction and stainless springs provide a lifetime of trouble-free use.

**SIZE RAISED:** 73" H x 31" W x 20 ½" D

**SIZE LOWERED:** 44" H x 31" W x 20 ½" D

**WINDOW SIZE:** 37.4" H x 27." W

**COLORS:** Standard white, grey or black. Custom options available.

**FRAME** Metal, Stainless Steel (Upgrade)

**SHIPPING:** Pallet: 48" x 40" x 10", 180 lbs / 81.65 kg

- Retractable Window
- Multiple heights
- Perfectly counter balanced
- Easily raised and lowered
- 1.0mm LE base
- .50mm LE lead acrylic window
- 2 high-quality hospital grade locking casters
- Complete with bar to hold controls

New steel frame adds strength and prevents bending or warping of viewing window



# STANDARD BARRIERS

Available in a variety of heights, widths, and window configurations, Infab barriers are fully customizable, to any specifications. Custom colors, logos and 100% stainless steel options are available. Full head-to-toe protection with our exclusive base curtain included on every barrier. Your choice of 2.0mm LE lead glass or .50mm LE acrylic window. All bases are 1.50mm LE.



## 683492

### LARGE WINDOW MOBILE BARRIER

**SIZE:** 80¼" H x 40½" W X 25" D  
**WINDOW:** 72" H x 36" W  
**GLASS:** Lead or Acrylic (-AC)  
**SHIPPING:** Crate: 30" x 78" x 48"  
 480lbs / 217.72 kg

## 683476

### X-TALL MOBILE BARRIER

**SIZE:** 78¼" H x 40½" W X 25" D  
**WINDOW:** 60" H x 36" W  
**GLASS:** Lead or Acrylic (-AC)  
**SHIPPING:** Crate: 30" x 78" x 48"  
 450lbs / 204.12 kg

## 683488

### X-WIDE MOBILE BARRIER

**SIZE:** 74½" H x 76½" W X 25" D  
**WINDOW:** 36" H x 72" W  
**GLASS:** Lead or Acrylic (-AC)  
**SHIPPING:** Crate: 32" x 85" x 85"  
 600lbs / 272.16 kg

## 683473

### MID-TALL MOBILE BARRIER

**SIZE:** 74½" H x 34½" W X 25" D  
**WINDOW:** 60" H x 30" W  
**GLASS:** Lead or Acrylic (-AC)  
**SHIPPING:** Crate: 73" x 30" x 43"  
 380lbs/172.36kg

## BARRIER FEATURES

- All Infab Barriers include four hospital grade casters, 2 with locking brakes.
- Fully enclosed glass with our exclusive concussion panels to protect the lead glass.
- Easy-clean Sintra plastic base and high quality powder coated steel frames.



### 683482

#### WIDE MOBILE BARRIER

**SIZE:** 72" H x 52½" W X 25" D  
**WINDOW:** 36" H x 48" W  
**GLASS:** Lead or Acrylic (-AC)  
**SHIPPING:** Crate: 30" x 72" x 60"  
 480 lbs / 217.72 kg

### 683465

#### SMALL WINDOW MOBILE BARRIER

**SIZE:** 72¼" H x 52½" W X 25" D  
**WINDOW:** 12" H x 12" W  
**GLASS:** Lead or Acrylic (-AC)  
**SHIPPING:** Crate: 30" x 72" x 60"  
 380 lbs / 217.72 kg

### 683468

#### MEDIUM WINDOW MOBILE BARRIER

**SIZE:** 74" H x 52½" W X 25" D  
**WINDOW:** 12" H x 24" W  
**GLASS:** Lead or Acrylic (-AC)  
**SHIPPING:** Crate: 73" x 30" x 57"  
 410 lbs / 185.97 kg

### 683460

#### STANDARD MOBILE BARRIER

**SIZE:** 72" H x 34½" W X 25" D  
**WINDOW:** 24" H x 30" W  
**GLASS:** Lead or Acrylic (-AC)  
**SHIPPING:** Crate: 30" x 72" x 42"  
 335 lbs / 151.95 kg

### 683484

#### REGULAR MOBILE BARRIER

**SIZE:** 64½" H x 40½" W X 25" D  
**WINDOW:** 24" H x 36" W  
**GLASS:** Lead or Acrylic (-AC)  
**SHIPPING:** Crate: 30" x 65" x 48"  
 430 lbs / 195.04 kg

### 683458

#### "SHORTY" MOBILE BARRIER

**SIZE:** 45" H x 34½" W X 25" D  
**WINDOW:** 24" H x 30" W  
**GLASS:** Lead or Acrylic (-AC)  
**SHIPPING:** Crate: 45" x 30" x 42"  
 220 lbs / 99.79 kg

New

**683495** ADJUSTABLE HEIGHT WRAPAROUND MOBILE BARRIER

An adjustable height, partial wraparound mobile barrier, designed for maximum protection. Easy to adjust and maneuver. Includes protection all the way to the floor.

- SIZE:** 42"-55" H x 36<sup>3</sup>/<sub>4</sub>" W; Tower 25" W  
Height adjusts from 42" to 55"  
Inside 20<sup>1</sup>/<sub>2</sub>" W x 17" D
- PROTECTION:** .50mm LE
- COLORS:** All fabric options
- SHIPPING:** Crate: 30" x 42" x 44", 210 lbs / 95.25 kg

- Powder coated steel frame
- 2 high-quality hospital grade locking casters
- Shipping worldwide by ground, air or sea freight



Easy to adjust height

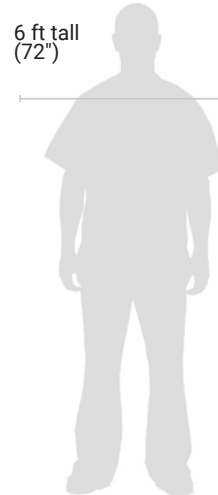

6 ft tall (72")



55"



Adjustable Height  
42" - 55"



Tower Width  
25"  
20<sup>1</sup>/<sub>2</sub>" W  
Inside

Inside  
17" D

## APRON RACKS

Infab Apron Racks are purpose-built pieces of hospital equipment, designed to last as long as the facility they are being used in.

### OPTIONS

- Mobile
- Wall-Mounted
- Single Apron
- Multi-Apron
- Deluxe
- Economy
- Custom Colors

### HOSPITAL GRADE MATERIALS

- Cold-rolled metal or optional stainless steel frames
- Hospital grade casters, two with locking brakes, for easy mobility and positive placement when parked.

### THOUGHTFUL DESIGN

- Easy to use
- Space-efficient
- Plentiful storage
- Easy on/off apron convenience



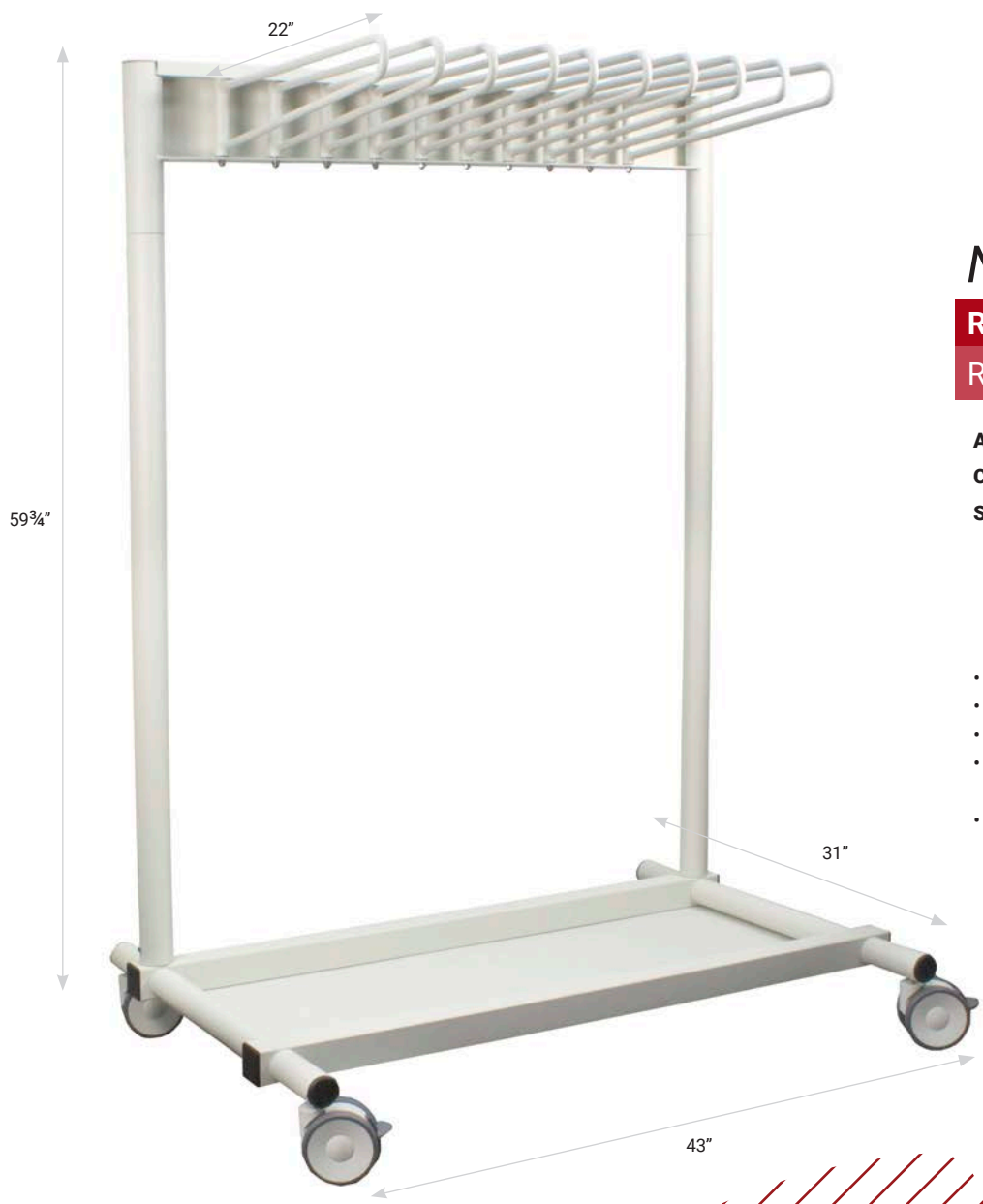

New

**REV-MRK-10**

**REVOLUTION 10 ARM MOBILE APRON RACK**

**ASSEMBLED SIZE:** 59 3/4" H x 43" W X 31" D

**COLORS:** White, Custom Options

**SHIPPING:** Box 1: 16" x 58" x 9", 52 lbs / 23.59 kg  
 Box 2: 34" x 45" x 14", 58 lbs / 26.31 kg

- Holds up to 10 vest and skirt aprons
- Vest and skirts hang on a single arm
- Handy storage area on base
- Heavy duty hangers that swivel on a sealed ball bearing for years of trouble-free use
- New circular tube design with sleek look

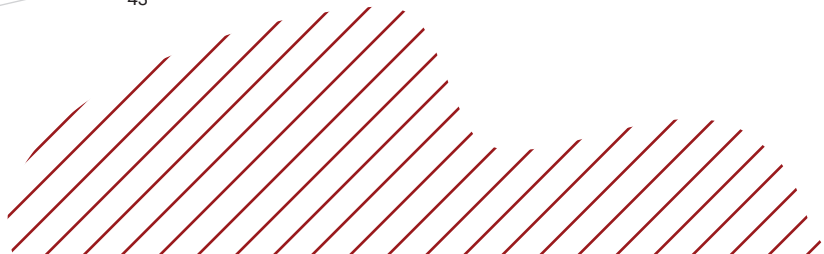
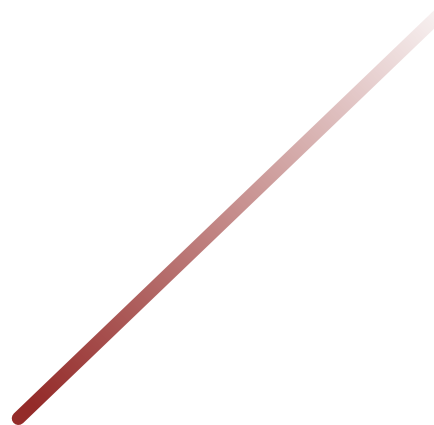



**683435**

### 10 HANGER MOBILE APRON VALET

**ASSEMBLED SIZE:** 58" H x 26½" W X 25" D

**COLORS:** White, Custom Options

**SHIPPING:** Box 1: 55" x 7" x 7", 25 lbs / 11.34 kg  
Box 2: 16" x 32" x 14", 34 lbs / 15.42 kg

- Space saving; providing major storage while taking up minimum space.
- Steel construction with baked enamel finish.
- 2 high-quality hospital grade locking casters
- 10 Deluxe Custom Apron Hangers (683450) included

**683438**

### 20 HANGER MOBILE APRON VALET

**ASSEMBLED SIZE:** 58" H x 48½" W X 25" D

**COLORS:** White, Custom Options

**SHIPPING:** Box 1: 55" x 7" x 7", 32 lbs / 14.51 kg  
Box 2: 16" x 32" x 14", 43 lbs / 19.50 kg

- Space saving; providing major storage while taking up minimum space.
- Steel construction with baked enamel finish.
- 2 high-quality hospital grade locking casters
- 20 Deluxe Custom Apron Hangers included
- Optional: full circle loop hangers (-H)

**683419**

### MINI MOBILE APRON RACK WITH HANGERS

**ASSEMBLED SIZE:** 78" H x 27" W X 25" D

**COLORS:** White, Custom Options

**SHIPPING:** Box: 29" x 49" x 8", 59 lbs / 26.76 kg

- Six apron hangers included
- Heavy gauge cold rolled steel
- Powder coated
- Attractive, durable, long lasting finish
- 2 high-quality hospital grade locking casters
- Holds up to six protection aprons, a pair of lead gloves and two pairs of radiation protection glasses

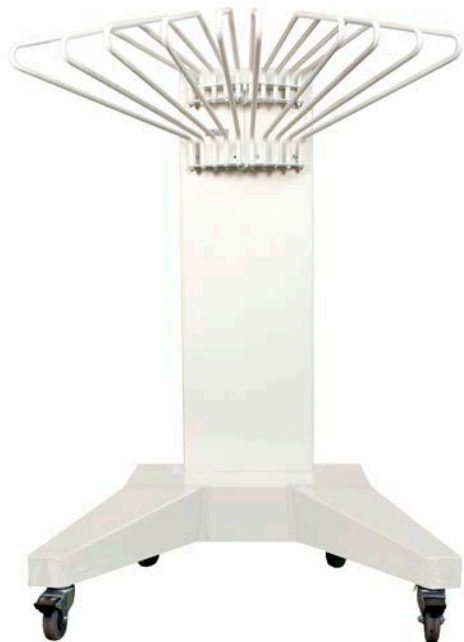

**683407**

**DELUXE MOBILE  
APRON RACK**

**ASSEMBLED SIZE:** 53" H x 39" W X 26" D

**COLORS:** White, Custom Options

**SHIPPING:** Box 1: 16" x 32" x 14", 25 lbs / 11.34 kg  
 Box 2: 40" x 29" x 12", 55 lbs / 24.95 kg  
 Box 3: 58" x 17" x 9", 52 lbs / 23.59 kg

- Super heavy-duty
- 2 high-quality hospital grade locking casters
- Stores up to ten protection aprons
- Optional vest and skirt adapter (Part Number 683000)
- Holds up to 200 lbs. of aprons



**683426**

**5 ARM BUDGET SAVER  
MOBILE APRON RACK**

**ASSEMBLED SIZE:** 58" H x 26" W X 30" D

**COLORS:** White, Custom Options

**SHIPPING:** Box 1: 51" x 7" x 7", 31 lbs / 14.06 kg  
 Box 2: 16" x 32" x 14", 34 lbs / 15.42 kg  
 Box 3: 16" x 41" x 7", 21lbs / 9.53 kg  
 Box 4: 26" x 21" x 2", 12 lbs / 5.44 kg

- Economically priced
- Heavy gauge steel
- Powder coated
- 2 high-quality hospital grade locking casters
- Stores up to 5 protection aprons
- Convenient additional storage on base
- Optional vest and skirt adapter (Part Number 683000)



**683427**

**10 ARM BUDGET SAVER  
MOBILE APRON RACK**

**ASSEMBLED SIZE:** 58" H x 44½" W x 30" D

**COLORS:** White, Custom Options

**SHIPPING:** Box 1: 51" x 7" x 7", 36 lbs / 16.33 kg  
 Box 2: 16" x 32" x 13", 34 lbs / 15.42 kg  
 Box 3: 58" x 16" x 9", 40 lbs / 18.14 kg  
 Box 4: 22" x 44" x 2", 21 lbs / 9.53 kg

- Economically priced
- Heavy gauge steel
- Powder coated
- 2 high-quality hospital grade locking casters
- Stores up to 10 protection aprons
- Convenient additional storage on base
- Optional vest and skirt adapter (Part Number 683000)

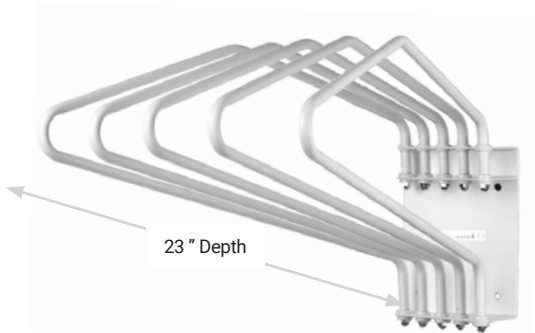
**683101**

5 Arm Left Folding Apron Rack

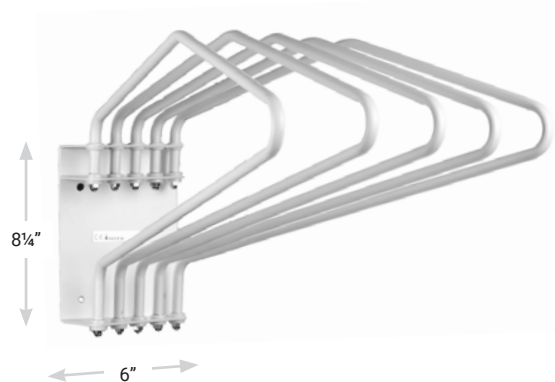
**683100**

5 Arm Right folding Apron Rack

**WALL-MOUNTED 5 ARM APRON RACK****ASSEMBLED SIZE:** 8 1/4" H x 6" W X 23" D**COLORS:** White, Custom Options

- Stores up to 5 aprons
- Swings out easily for immediate access to aprons
- Heavy duty
- Power coated steel mounting bracket and storage arms
- Arms with nylon bushings
- Racks fold flush to wall
- Can be mounted side by side
- Optional vest and skirt adapter (Part Number 683000)

**683000**

Vest and Skirt Rack Adapter

Skirt rack adapter easily mounts to rack with included tool. Skirt hanging adapter provides convenient storage for vest & skirt aprons.

**SHIPPING****683100** 5 Arm Folding Right Hand Folding

Box 1: 10 lbs (12" x 30" x 6")

**683101** 5 Arm Folding Left Hand Folding

Box 1: 10 lbs (12" x 30" x 6")

**683415 WALL-MOUNTED WALL TOWER RACK**

**ASSEMBLED SIZE:** 48" H x 13 3/4" W X 27" D (w/racks)

**COLORS:** White, Custom Options

- Includes right and left 5 arm apron racks
- Heavy duty
- Handles toughest hospital environments
- Heavy gauge steel
- Powder coated
- Scratch resistant
- Easy to install
- Hardware provided
- Requires only minimal space
- 13.75" wide x 48" tall

**SHIPPING**

683115 Weak Wall Support

683415 Rack/Tower W/ R.H. & L.H. Racks

Box 1: 10 lbs (12" x 30" x 6")

Box 1: 10 lbs (12" x 30" x 6")

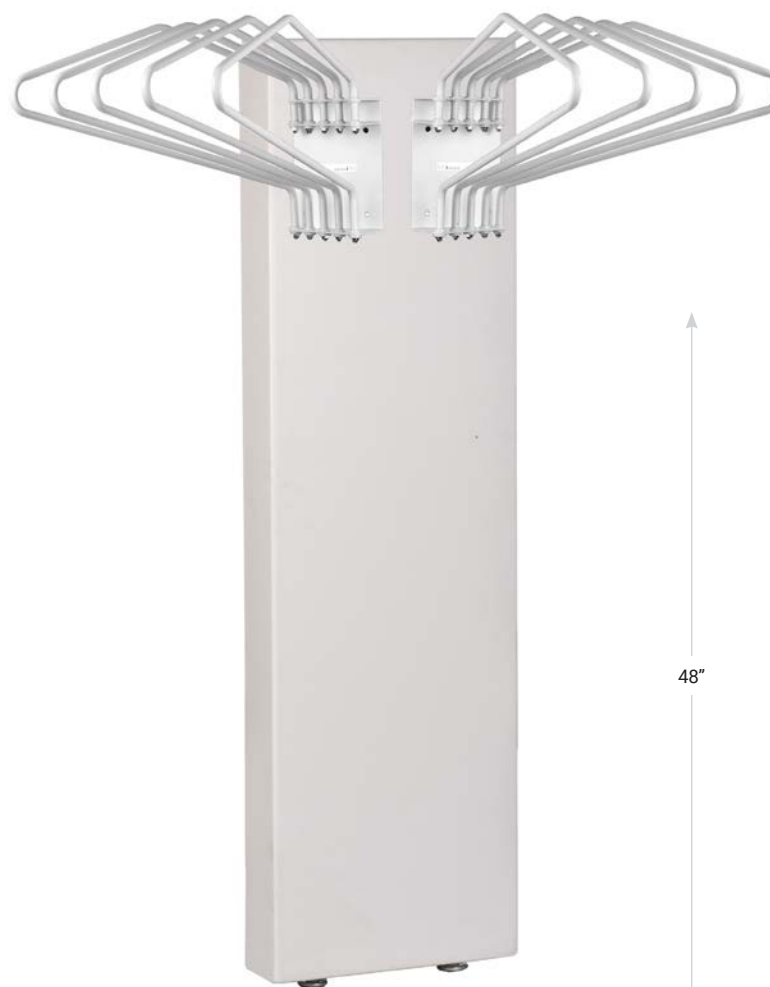

**683415**  
Wall Tower Rack with right and left hand racks

13 3/4"

48"



**683115**  
Weak Wall Support

**683429 WALL MOUNTED RACK****ASSEMBLED SIZE:** 12" H x 36" W X 26" D**COLORS:** White, Custom Options

- Heavy gauge steel
- 200 lbs. Capacity
- Powder coated
- Scratch resistant
- Easy to install
- Requires only minimal space
- Stores up to 10 aprons
- Optional vest and skirt adapter (Part Number 683000)

**683429 SHIPPING**

Box 1: 40 lbs (16" x 58" x 9")

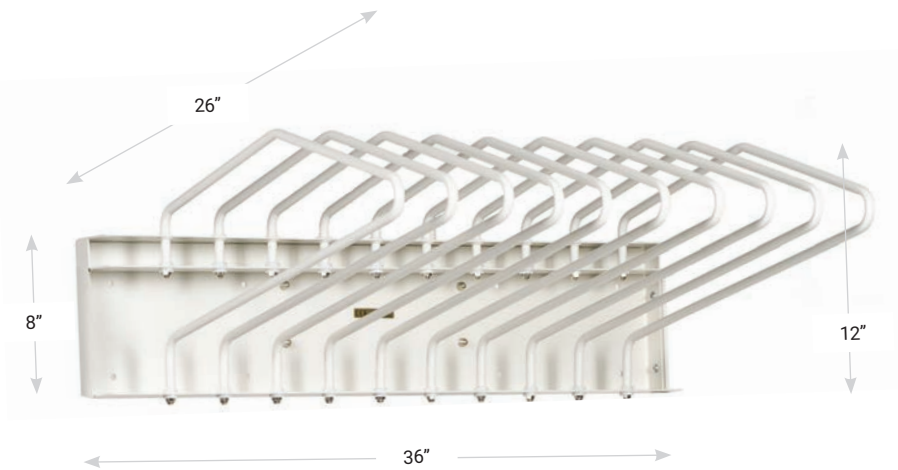
**683430 APRON AND GLOVE COMBINATION RACK****ASSEMBLED SIZE:** 17" H x 28<sup>3</sup>/<sub>4</sub>" W (9<sup>1</sup>/<sub>2</sub>" Baseplate)**COLORS:** White, Custom Options

- Rounded corners to prevent accidental apron tears or skin punctures
- Quick, convenient storage
- Stores 1 apron and 1 pair of lead gloves
- Sturdy & compact
- Mounts quickly and easily
- Heavy gauge steel mounting plate
- Half inch outside diameter tubing
- Electro static powder coated

**683430 SHIPPING**

Box 1: 9 lbs. (19" x 30" x 11")

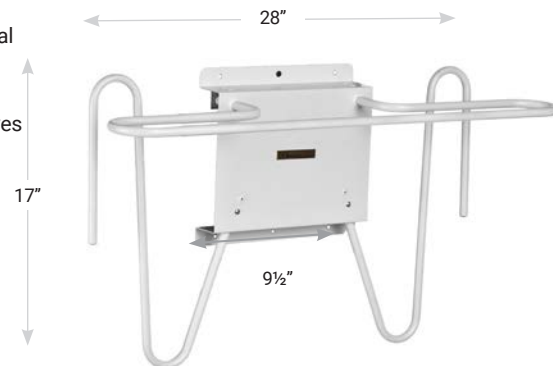
**683420 APRON AND GLOVE STORAGE RACK****ASSEMBLED SIZE:** 25" H x 28" W x 6" D**COLORS:** White, Custom Options

- Quick, convenient storage
- Sturdy
- Compact
- Mounts quickly and easily
- Heavy gauge steel mounting plate
- Half inch outside diameter tubing
- Electro static powder coated
- Great for dental aprons

**683420 SHIPPING**

Box 1: 15 lbs (26" x 31" x 8")



**683102** PROTECTIVE ACCESSORIES RACK



**ASSEMBLED SIZE:** 21" H x 18½" x 5" D

**COLORS:** White, Custom Options

- Storage unit for two or more aprons, a pair of glasses and a pair of lead gloves
- Mounts quickly and easily
- 18" wide
- Extends a mere 4.5" from the wall
- Contains no sharp edges
- Perfectly suited to small areas
- Powder coated heavy steel construction

**683102 SHIPPING**

Box 1: 8 lbs (19" x 23" x 8")

**683424** SINGLE BAR APRON RACK



**ASSEMBLED SIZE:** 6" H x 18 ½" W x 3" D

**COLORS:** White, Custom Options

- Storage unit for one apron
- Mounts quickly and easily
- Contains no sharp edges
- Perfectly suited to small areas
- Powder coated heavy steel construction

**683102 SHIPPING**

Box 1: 3 lbs (24" x 4" x 8")

**683452** LOCKER SIZE HANGER



**SIZE:** 6" H x 14 ½" W

**COLORS:** White, Custom Options

- Securely hold a radiation protection apron
- Constructed from heavy gauge steel tube
- Designed to fit in personal locker
- Powder Coated



Optional hook (-H)

**683450** DELUXE CUSTOM HANGER



**SIZE:** 7½" x 22½"

**COLORS:** White, Custom Options

- Securely hold a radiation protection apron
- Constructed from heavy gauge steel tube
- Powder coated
- "No slip" tubing shield
- Available in a pack of 5 hangers - Part Number 683451



Optional hook (-H)

**683412 TWO PEG WALL MOUNTED RACK**

**683412** Two Peg Wall Mounted Rack  
**683412-LS** Two Peg Wall Mounted Rack with Locking System

**ASSEMBLED SIZE:** 9" H x 15 ¼" W x 7¼" D  
**COLORS:** White, Custom Options  
**SHIPPING:** Box: 11" x 18" x 9", 6 lbs / 2.72 kg

**683410 SIX PEG WALL MOUNTED RACK**

**683410** Six Peg Wall Mounted Rack  
**683410-LS** Six Peg Wall Mounted Rack with Locking System

**ASSEMBLED SIZE:** 9" H x 34 ½" W x 7 ¼" D  
**COLORS:** White, Custom Options  
**SHIPPING:** Box: 11" x 37" x 9", 16 lbs / 7.26 kg

**683411 EIGHT PEG WALL MOUNTED RACK**

**683411** Eight Peg Wall Mounted Rack  
**683411-LS** Eight Peg Wall Mounted Rack with Locking System

**ASSEMBLED SIZE:** 9" H x 34¼" W x 7¼" D  
**COLORS:** White, Custom Options  
**SHIPPING:** Box: 13" x 47" x 10", 21 lbs / 9.53 kg

**LS LOCKING SYSTEM**

- Available in 2 peg, 6 peg, or 8 peg configurations
- Inexpensive and very effective
- Heavy gauge steel plate
- Electrostatic powder coated
- Tilted storage bars so aprons wont slip off
- Requires minimal space
- Includes lock



REV-LOCKER-20

## REVOLUTION MOBILE APRON LOCKERS

- Features digital passcode locks with keypad
- Set up to 3 administrative and user passcodes
- Battery operated lock with backup battery and emergency power supply
- T-Handle with 2-cable latch/release system to lock at top and bottom



Hangers Included



Passcode Lock with Keypad





### REV-LOCKER-5

#### REVOLUTION 5 HANGER MOBILE APRON LOCKER

**ASSEMBLED SIZE:** 65" H x 16" W x 26.5" D

**COLORS:** White, Grey, or Black  
Custom colors available.  
Ships in standard white unless specified.

**SHIPPING:** Crate: 29" x 20" x 70", 170 lbs / 77.11 kg

- Includes 5 hangers
- Secure up to 5 aprons



### REV-LOCKER-10

#### REVOLUTION 10 HANGER MOBILE APRON LOCKER

**ASSEMBLED SIZE:** 65" H x 32" W X 26.5" D

**COLORS:** White, Grey, or Black  
Custom colors available.  
Ships in standard white unless specified.

**SHIPPING:** Crate: 29" x 36" x 70", 205 lbs / 93 kg

- Includes 10 hangers
- Secure up to 10 aprons



### REV-LOCKER-20

#### REVOLUTION 20 HANGER MOBILE APRON LOCKER

**ASSEMBLED SIZE:** 65" H x 48" W X 26.5" D

**COLORS:** White, Grey, or Black  
Custom colors available.  
Ships in standard white unless specified.

**SHIPPING:** Pallet: 29" x 52" x 70", 230 lbs / 148.33 kg

- Includes 20 hangers
- Secure up to 20 aprons



## CURTAINS

Infab's line of radiation protection curtains provide the highest level of quality while offering full customization. These high quality curtains are available with a heavy-duty track that is built to your specifications. Our curtain tracks are available either straight or curved to ensure you get the right fit for your room. Infab's radiation protection curtains are available in multiple levels of protection as well as any size, colors and fabrics that we offer.

### Custom Sizes

Our radiation protection curtains are custom manufactured to whatever specifications you need. We will work with you to make sure that your curtains arrive exactly how you want them, and as quickly as possible.

### Custom Tracks

Infab knows not every room is built the same. If you need a curved track for your Infab radiation protection curtains, we are happy to build it for you at your exact specifications. Infab will gladly work with you to create the exact curtain and track you need to make your room perfect and functional.

Contact us with your configuration for an instant quote.

## LEAD CURTAIN



Our lead curtains include one grommet hole with a "S" hook every six inches.

- COLORS:** Classic Nylon Colors
- CORE:** Lightweight Lead, KIARMOR Bi-Layer Low-Lead, KIARMOR Bi-Layer Lead-Free
- PROTECTION:** .25mm LE, .35mm LE, .50mm LE, .75mm LE, 1.0mm LE
- SIZE:** Per square foot
- 683650** .25mm LE curtain with Grommets (per sq. ft.)
- 683655** .35mm LE curtain with Grommets (per sq. ft.)
- 683660** .50mm LE curtain with Grommets (per sq. ft.)
- 683670** .75mm LE curtain with Grommets (per sq. ft.)
- 683675** 1.0mm LE curtain with Grommets (per sq. ft.)

**683680 STRAIGHT TRACK FOR CURTAIN**

Mill finish 6063-T5 extruded aluminum 1-3/4" wide x 2" high, .080 thick.  
**Priced per linear foot.**

- INCLUDES:**
- 1 Straight Track
  - 2 End Stops
  - 1 Single Carrier for each grommet hole on curtain

- OPTIONS:**
- Clamp Hanger
  - Ceiling Splice
  - Trim Chain



**OPTIONS:**

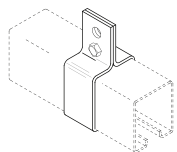

**Clamp Hanger**  
 Formed steel brackets clamp to track. Adjusts to any position. Suspend track with welded chain or wire rope. 1 pair pictured.

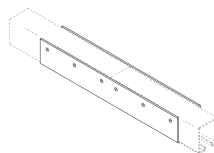

**Ceiling Splice**  
 To align and lock track sections together on ceiling mounted tracks. 1 pair pictured.  
Note: Cannot be used with No. 132 Overlap Master or No. 10 Pivot Device due to interference with the wheels.



**Trim Chain**  
 3 links No.10 single jack chain added to carriers to provide 3" of curtain height adjustment

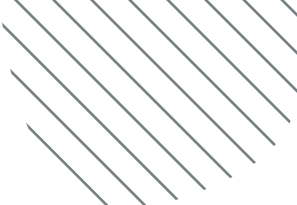

**683690 CURVED TRACK FOR CURTAIN**

Mill finish 6063-T5 extruded aluminum 5/8" wide x 1-11/16" high, 0094" thick.  
For curved track applications only. **Each piece requires custom quoting.**

- INCLUDES:**
- 1 Curved Track
  - 2 End Stops
  - 1 Single Carrier for each grommet hole of curtain
- OPTIONS:**
- Clamp Hanger
  - Ceiling Splice
  - Ceiling Hanger
  - Trim Chain



**Single Carrier**  
2 polyethylene wheels riveted to plated steel body with swivel hook.

**End Stop**  
Bolt with horizontal pipe spacer to prevent carriers from traveling beyond desired location. For use with walk-along tracks.

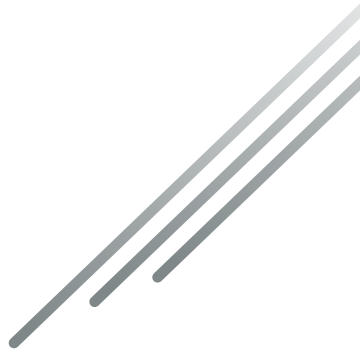

**Trim Chain**  
3 links No.10 single jack chain added to carriers to provide 3" of curtain height adjustment

**OPTIONS:**

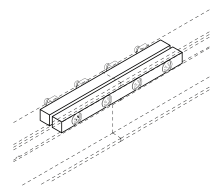

**Splice**  
Steel plates align and lock track together. 1 pair pictured.

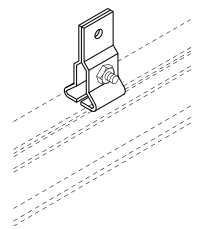

**Clamp Hanger**  
Formed steel brackets clamp to track. Adjusts to any position. Suspend track with welded chain or wire rope. 1 pair pictured

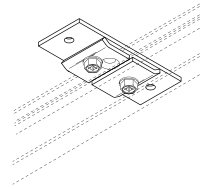

**Ceiling Hanger**  
Steel plate mounts flush to ceiling. Track clamps to bracket with offset clips.

# TABLE MOUNT SCATTER SHIELDS

These scatter shields are attached to the table to protect both the operator and the patient from harmful radiation. The upper part of the screen (removable) protects against scatter radiation from the patient's body. The lower part protects the operator's lower body against the radiation from the tube source.

## Easy Setup & Installation

Easily slides on to most tables with side rails and quickly locks in to place with an adjustable knob.

Universal adapter bracket fits almost every table with a side rail.

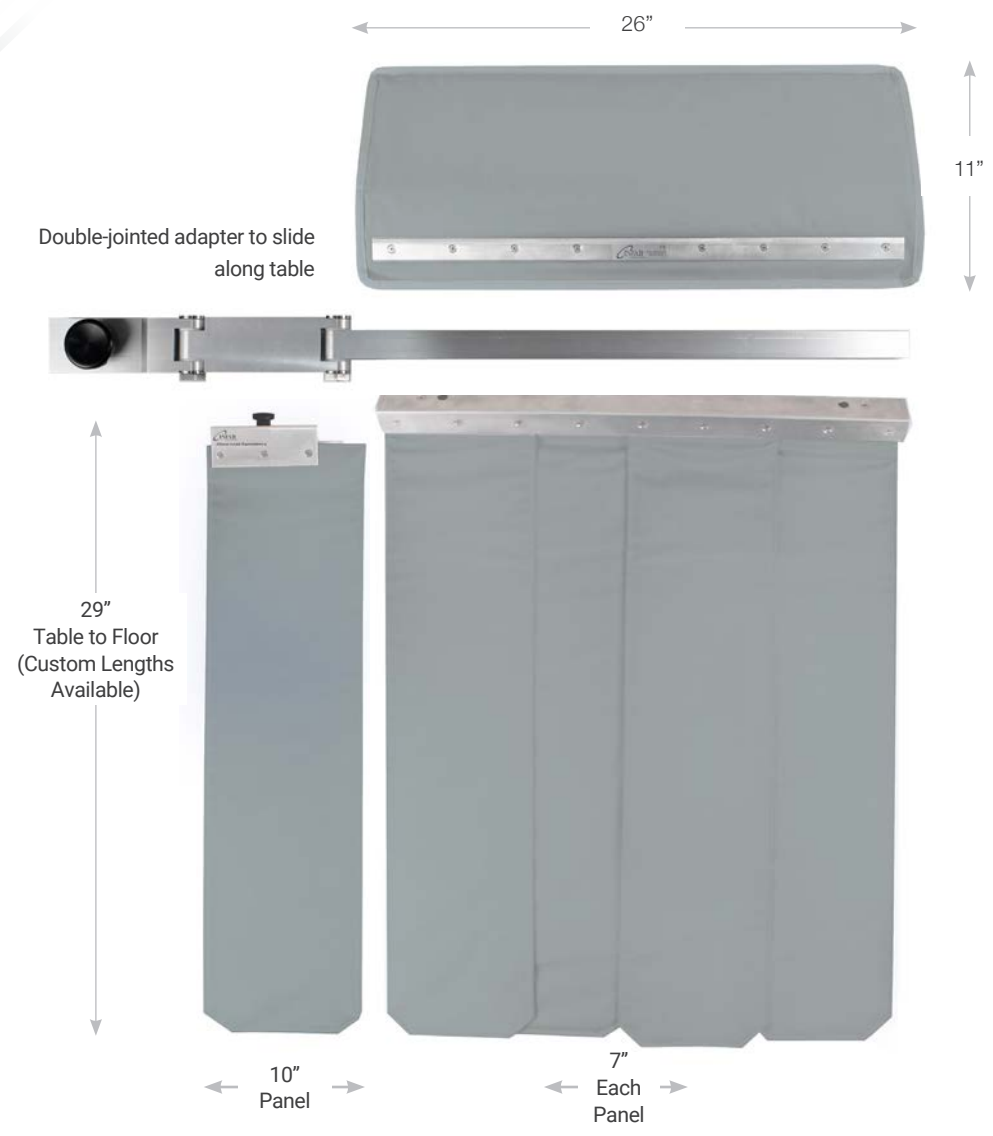

Swivel Arm for easy movement of screen



Universal Adapter



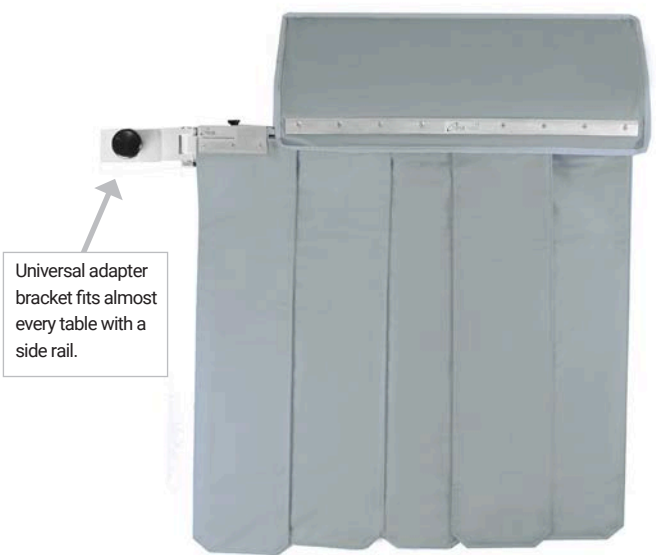
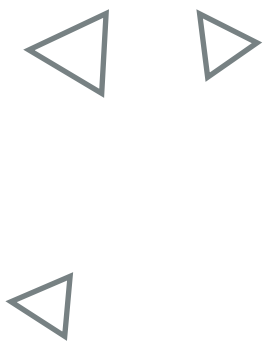

Universal adapter bracket fits almost every table with a side rail.

## 077035 MULTIPLE PANEL SCATTER SHIELD

- Upper Screen
- .50mm LE with stiff support
  - 11" H x 26" W
  - Hooks into mobile arm that can be easily removed
- Lower Screen
- .50mm LE made up of 4 strips
  - 30" L x 26" W
  - Additional Strip (Included)
  - Applied with addition of intermediate joint
  - 30" L x 10" W



Universal adapter bracket fits almost every table with a side rail.

## 077036 SINGLE PANEL SCATTER SHIELD

- Upper Screen
- .50mm LE with stiff support
  - 11" H x 26" W
  - Hooks into mobile arm that can be easily removed.
- Lower Screen
- .50mm LE made up of 1 strip
  - 30" L x 26" W



**990007 SADDLE SHIELD RADIATION PROTECTION CURTAINS**

- Custom sizing and configuration available
- Easy to install, extremely effective at drastically reducing scatter radiation.
- Available in all of our classic nylon colors and patterns.

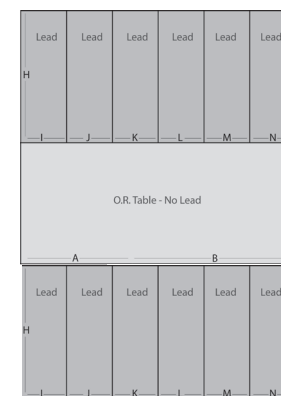
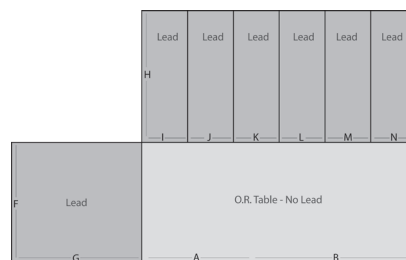
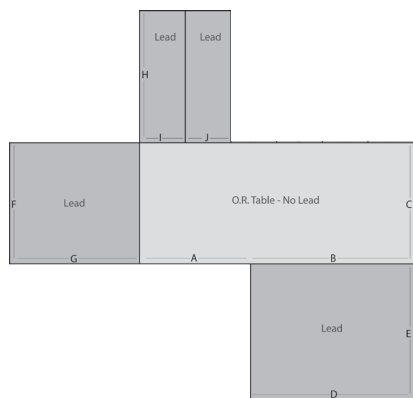
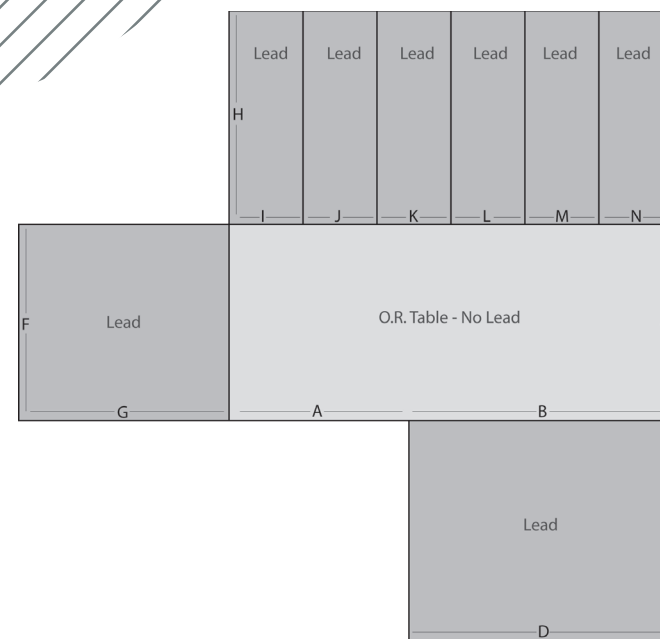

**683400 PATIENT PROTECTION SET**

- INCLUDES:** Storage rack with 4 aprons (Toddler, Child, Average, Large)
- COLORS:** Classic Nylon Colors
- CORE:** Lightweight Lead, KIARMOR Bi-Layer Low-Lead, KIARMOR Bi-Layer Lead-Free
- PROTECTION:** .25mm LE, .35mm LE, .50mm LE
- SIZES:** Toddler, Child, Average Adult, Large Adult



683401  
9" H x 11.5" W  
Toddler Apron

683402  
13" H x 13" W  
Child's Apron

683403  
14" H x 17.5" W  
Average Adult Apron

683404  
17" H x 21" W  
Large Adult Apron

**HALF APRON**

**HSV**  
Hook and Loop Closure Half Apron

- HSV-S1** 12" x 24" Half apron with hook and loop closure
- HSV-M1** 18" x 24" Half apron with hook and loop closure
- HSV-L1** 24" x 24" Half apron with hook and loop closure



Standard hook and loop closure

**ASB**  
Buckle Closure Half Apron

- ASB-S1** 12" x 24" Half apron with buckle closure
- ASB-M1** 18" x 24" Half apron with buckle closure
- ASB-L1** 24" x 24" Half apron with buckle closure





**PP-ES** DISPOSABLE EYE SHIELDS



- Minimum 40% Dose Reduction
- Box of 50
- Barium sulfate shields are non-latex and 100% disposable

**PP-TS** DISPOSABLE THYROID SHIELD

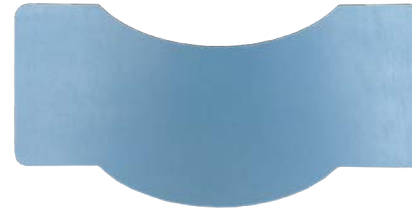

- Minimum 60% Dose Reduction
- Box of 50
- Barium sulfate shields are non-latex and 100% disposable

**684120** OVARIAN SHIELDS



- Set of the three (Infant, Youth and Adult)
- Designed especially for ovarian procedures
- 1.0mm LE
- Easy to use and explain to your patient
- Available in our Classic Nylon Colors
- Durable
- Easily wipes clean

**PGS** GONAD SHIELDS



- Set of three or available individually: Infant, Youth and Adult
- 3/4" tie strap
- Easy fastening around the waist
- .50mm LE
- Available in our Classic Nylon Colors

**GND** TRIANGULAR GONAD



- Set of three or available individually: Infant, Youth and Adult
- 1/2" tie strap
- Easy fastening around the waist
- .50mm LE
- Available in our Classic Nylon Colors

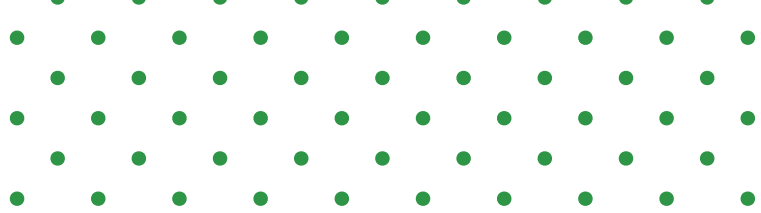

**PTD** PATIENT TRANSFER DEVICE

- Radiolucent plastic
- 18" or 22" wide models
- Also available with storage rack
- Large hand holds
- One inch wide wrist straps
- Anti-static
- Thin
- Board slides easily from surface to surface
- Tested up to 300 lbs.

**MODELS:** PDT-18, PDT-22  
**COLORS:** White  
**SHIPPING:** PDT-18  
 Box: 73" x 23" x 1", 11 lbs / 4.99 kg  
 PDT-22  
 Box: 73" x 23" x 1", 13 lbs / 5.90 kg



**FEATURE YOUR COMPANY LOGO**  
 Upcharge applies



**683399** PATIENT TRANSFER RACK

Wall mounted rack for PTD storage  
**SIZE** 9" H X 15" 1/4 W x 6 3/4" D

# Core Material Testing by Independent Agency



**NATIONAL PHYSICAL LABORATORY**  
Teddington Middlesex UK TW11 0LW Telephone +44 20 8977 3222

## Certificate of Calibration

Determination of the shielding properties  
of Bi-layer Lead-free vinyl samples

This certificate provides traceability of measurement to the SI system of units insofar as units of measurement realised at the National Physical Laboratory or other recognised national metrology institutes. This certificate may not be reproduced other than in full, unless permission for the publication of an approved extract has been obtained in writing from the Managing Director. It does not of itself impute to the subject of calibration any attributes beyond those shown by the data contained herein.

---

**FOR:** Infab Corporation  
1040 Avenida Acaso  
Camarillo, CA 93012  
USA

**DESCRIPTION:** Determination of Lead equivalence of Bi-layer Lead-free vinyl samples in accordance with BS EN 61331-1:2014 using the inverse broad beam geometry.

**DATE OF MEASUREMENTS:** 29 July 2015

---

Reference: 2015070344\_2  
Date of Issue: 06 August 2015  
Checked by: *[Signature]*

Page 1 of 3  
Signed: *[Signature]*  
(Authorised signatory)  
Name: G A Bass  
for Managing Director

Infab Corporation protective material is extensively tested by multiple INDEPENDENT professional agencies and testing facilities using the latest scientific methods before it ever becomes your radiation protection apron.

In actual independent side by side tests, Infab Corporation protective aprons attenuate higher across a larger spectrum of direct beam kVp and are lighter weight at those attenuation levels than any other manufacturer's aprons in the world.

Real testing, real data, real protection.  
That's the Infab difference.

**NATIONAL PHYSICAL LABORATORY**  
Continuation Sheet

**CONDITIONS:**

from x-ray tube to target sample: 0.8m  
chamber used: PTW TW34060-2.5 s/n 000259

Equipment associated with the measurements performed in this report has direct traceability to UK standards or UKAS accredited calibration facilities.

Table I  
61331-1:2014 X-ray beam qualities

X-ray Tube Voltage kV	Total filtration mmAl*
50	2.5
70	2.5
90	2.5
110	2.5
120	2.5
150	2.5

\*The inherent filtration of the x-ray tube was determined to be 0.3mmAl equivalent

---

Reference: 2015070344\_2  
Checked by: *[Signature]*

Page 2 of 3

**NATIONAL PHYSICAL LABORATORY**  
Continuation Sheet

**RESULTS:**

Attenuation = 1 - attenuated/un-attenuated x 100

Table II  
Bi-layer Lead-free vinyl sheet, 0.25mm nominal Lead equivalent

kV	Equivalent Lead thickness mm	Attenuation %	PASS/FAIL
50	0.2344	98.7	PASS
70	0.2766	96.1	PASS
90	0.2867	92.0	PASS
110	0.2759	87.8	PASS
120	0.2702	85.8	PASS
150	0.2570	80.1	PASS

**UNCERTAINTIES**

The uncertainty in the Lead equivalence is ±5%. The reported expanded uncertainty is based on a standard uncertainty multiplied by a coverage factor  $k = 2$ , providing a level of confidence of approximately 95%.

Clause 5.5.3 of IEC 61331-1:2014 states that a relative standard uncertainty of 7% be taken into account in the decision of conformity in assigning the class of the Lead equivalent thickness to the material under test. If  $t_{pb}$  is the standard Lead equivalent thickness class (0.25mm, 0.35mm, 0.5mm or 1mm) and  $\delta_{IB}$  is the Lead equivalence of the material under test, the condition can be written as:

$$\delta_{IB} \geq 0.93t_{pb}$$

---

Reference: 2015070344\_2  
Checked by: *[Signature]*

Page 3 of 3



NATIONAL PHYSICAL LABORATORY

Teddington Middlesex UK TW11 0LW Telephone +44 20 8977 3222

**Certificate of Calibration**  
Determination of the shielding properties  
of Bi-layer Lead-free vinyl samples

This certificate provides traceability of measurement to the SI system of units and/or to units of measurement realised at the National Physical Laboratory or other recognised national metrology institutes. This certificate may not be reproduced other than in full, unless permission for the publication of an approved extract has been obtained in writing from the Managing Director. It does not of itself impute to the subject of calibration any attributes beyond those shown by the data contained herein.

**FOR:** Infab Corporation  
1040 Avenida Acaso  
Camarillo, CA 93012  
USA

**DESCRIPTION:** Determination of Lead equivalence of Bi-layer Lead-free vinyl samples in accordance with BS EN 61331-1:2014 using the inverse broad beam geometry.

**DATE OF MEASUREMENTS:** 27 April 2015 – 05 May 2015

**Reference:** 2015050150\_8  
**Date of Issue:** 26 May 2015  
**Checked by:**

**Signed:**   
**Name:** G A Bass  
for Managing Director

Page 1 of 3  
(Authorised signatory)  
for Managing Director

NATIONAL PHYSICAL LABORATORY

Continuation Sheet

**CONDITIONS:**

Distance from x-ray tube to target sample: 0.8m  
Ionisation chamber used: Radcal 10x5-60E s/n 9088

All equipment associated with the measurements performed in this report has direct traceability to UK national standards or UKAS accredited calibration facilities.

**Table I**  
61331-1:2014 X-ray beam qualities

X-ray Tube Voltage kV	Total filtration mmAl*
50	2.5
70	2.5
90	2.5
110	2.5
120	2.5
150	2.5

\*The inherent filtration of the x-ray tube was determined to be 0.3mmAl equivalent

**Reference:** 2015050150\_8  
**Checked by:**

Page 2 of 3

NATIONAL PHYSICAL LABORATORY

Continuation Sheet

**LTS:**  
LTS = 1 – attenuated/un-attenuated x 100

**Table II**  
Bi-layer Lead-free vinyl sheet, 0.35mm nominal Lead equivalent

kV	Equivalent Lead thickness mm	Attenuation %	PASS/FAIL
50	0.3354	99.6	PASS
70	0.3679	98.0	PASS
90	0.3680	95.3	PASS
110	0.3599	92.7	PASS
120	0.3546	91.5	PASS
150	0.3396	88.1	PASS

**Table III**  
Bi-layer Lead-free vinyl sheet, 0.50mm nominal Lead equivalent (0.25mm double layer)

kV	Equivalent Lead thickness mm	Attenuation %	PASS/FAIL
50	0.5*	>99.9	
70	0.5563	99.4	PASS
90	0.5538	97.8	PASS
110	0.5208	96.3	PASS
120	0.5044	95.5	PASS
150	0.4696	93.0	PASS

The response of the ionisation chamber was too low to measure accurately. This value was extrapolated from a straight line fit of the 70-150kV qualities.

**UNCERTAINTIES**

The uncertainty in the Lead equivalence is ±5%. The reported expanded uncertainty is based on a standard uncertainty multiplied by a coverage factor  $k=2$ , providing a level of confidence of approximately 95%.

5.5.3 of IEC 61331-1:2014 states that a relative standard uncertainty of 7% be taken into account in the decision of conformity in assigning the class of the Lead equivalent thickness to the material under test. If  $\rho_B$  is the standard Lead equivalent thickness class (0.25mm, 0.35mm, 0.5mm) or  $\delta_{IB}$  is the Lead equivalence of the material under test, the condition can be written as:

$$\delta_{IB} \geq 0.93\rho_B$$

**Reference:** 2015050150\_8  
**Checked by:**

Page 3 of 3



NATIONAL PHYSICAL LABORATORY  
Teddington Middlesex UK TW11 0LW Telephone +44 20 8977 3222

### Certificate of Calibration

#### Determination of the shielding properties of Bi-layer Reduced-Lead vinyl samples

This certificate provides traceability of measurement to the SI system of units and/or to units of measurement realised at the National Physical Laboratory or other recognised national metrology institutes. This certificate may not be reproduced other than in full, unless permission for the publication of an approved extract has been obtained in writing from the Managing Director. It does not of itself impinge to the subject of calibration any attributes beyond those shown by the data contained herein.

**FOR:** Infab Corporation  
1040 Avenida Acaso  
Camarillo, CA 93012  
USA

**DESCRIPTION:** Determination of Lead equivalence of Bi-layer Reduced-Lead vinyl samples in accordance with BS EN 61331-1:2014 using the inverse broad beam geometry.

**DATE OF MEASUREMENTS:** 29 July 2015

Reference: 2015070344\_1  
Date of Issue: 06 August 2015  
Checked by: *[Signature]*

Signed: *[Signature]*

Page 1 of 3  
(Authorised signatory)  
Name: G A Bass  
for Managing Director

### NATIONAL PHYSICAL LABORATORY

Continuation Sheet

**CONDITIONS:**

Distance from x-ray tube to target sample: 0.8m  
Ionisation chamber used: PTW TW34060-2.5 s/n 000259

All equipment associated with the measurements performed in this report has direct traceability to UK national standards or UKAS accredited calibration facilities.

Table I  
61331-1:2014 X-ray beam qualities

X-ray Tube Voltage kV	Total filtration mmAl*
50	2.5
70	2.5
90	2.5
110	2.5
120	2.5
150	2.5

\*The inherent filtration of the x-ray tube was determined to be 0.3mmAl equivalent

Reference: 2015070344\_1  
Checked by: *[Signature]*

Page 2 of 3

### NATIONAL PHYSICAL LABORATORY

Continuation Sheet

**RESULTS:**

Transmission = 1 - attenuated/un-attenuated x 100

Table II  
Bi-layer Reduced-Lead vinyl sheet, 0.25mm nominal Lead equivalent

kV	Equivalent Lead thickness mm	Attenuation %	PASS/FAIL
50	0.2518	98.9	PASS
70	0.2882	96.5	PASS
90	0.2968	92.5	PASS
110	0.2868	88.5	PASS
120	0.2799	86.5	PASS
150	0.2658	80.9	PASS

**UNCERTAINTIES**

The uncertainty in the Lead equivalence is ±5%. The reported expanded uncertainty is based on a standard uncertainty multiplied by a coverage factor  $k = 2$ , providing a level of confidence of approximately 95%.

Section 5.5.3 of IEC 61331-1:2014 states that a relative standard uncertainty of 7% be taken into account in the decision of conformity in assigning the class of the Lead equivalent thickness to the material under test. If  $t_{ps}$  is the standard Lead equivalent thickness class (0.25mm, 0.35mm, 0.5mm or 0.7mm) and  $\delta_{tB}$  is the Lead equivalence of the material under test, the condition can be written as:

$$\delta_{tB} \geq 0.93t_{ps}$$

Reference: 2015070344\_1  
Checked by: *[Signature]*

Page 3 of 3



NATIONAL PHYSICAL LABORATORY  
Teddington Middlesex UK TW11 0LW Telephone +44 20 8977 3222

**Certificate of Calibration**  
Determination of the shielding properties  
of Lead vinyl samples

This certificate provides traceability of measurement to the SI system of units and/or to units of measurement realised at the National Physical Laboratory or other recognised national metrology institutes. This certificate may not be reproduced other than in full, unless permission for the publication of an approved extract has been obtained in writing from the Managing Director. It does not of itself impute to the subject of calibration any attributes beyond those shown by the data contained herein.

**FOR:** Infab Corporation  
1040 Avenida Acaso  
Camarillo, CA 93012  
USA

**DESCRIPTION:** Determination of Lead equivalence of Lead vinyl samples in accordance with BS EN 61331-1:2014 using the inverse broad beam geometry.

**DATE OF MEASUREMENTS:** 27 April 2015 – 05 May 2015

Reference: 2015050150\_4  
Date of Issue: 22 May 2015  
Checked by:

Signed:   
Name: G A Bass

Page 1 of 3  
(Authorised signatory)  
for Managing Director

NATIONAL PHYSICAL LABORATORY  
Continuation Sheet

**CONDITIONS:**

Room x-ray tube to target sample: 0.8m  
Chamber used: Radcal 10x5-60E s/n 9088

Consistent associated with the measurements performed in this report has direct traceability to UK standards or UKAS accredited calibration facilities.

Table I  
61331-1:2014 X-ray beam qualities

X-ray Tube Voltage kV	Total filtration mmAl*
50	2.5
70	2.5
90	2.5
110	2.5
120	2.5
150	2.5

The inherent filtration of the x-ray tube was determined to be 0.3mmAl equivalent

Reference: 2015050150\_4  
Checked by:

Page 2 of 3

NATIONAL PHYSICAL LABORATORY  
Continuation Sheet

**RESULTS:**

Attenuation = 1 – attenuated/un-attenuated x 100

Table II  
Lightweight Lead vinyl sheet, 0.25mm nominal Lead equivalent

kV	Equivalent Lead thickness mm	Attenuation %	PASS/FAIL
50	0.2395	98.8	PASS
70	0.2520	95.1	PASS
90	0.2534	90.7	PASS
110	0.2601	87.5	PASS
120	0.2592	86.2	PASS
150	0.2611	82.7	PASS

Table III  
Lightweight Lead vinyl sheet, 0.35mm nominal Lead equivalent (0.175mm double layer)

kV	Equivalent Lead thickness mm	Attenuation %	PASS/FAIL
50	0.3400	99.7	PASS
70	0.3417	97.6	PASS
90	0.3409	94.5	PASS
110	0.3490	92.3	PASS
120	0.3475	91.3	PASS
150	0.3507	88.6	PASS

Table IV  
Lightweight Lead vinyl sheet, 0.50mm nominal Lead equivalent (0.25mm double layer)

kV	Equivalent Lead thickness mm	Attenuation %	PASS/FAIL
50	0.5*	>99.9	
70	0.4980	99.1	PASS
90	0.4966	97.4	PASS
110	0.5067	96.1	PASS
120	0.5076	95.5	PASS
150	0.5107	93.0	PASS

\*The response of the ionisation chamber was too low to measure accurately. This value was extrapolated from a straight line fit of the 70-150kV qualities.

**UNCERTAINTIES**

The uncertainty in the Lead equivalence is ±5%. The reported expanded uncertainty is based on a standard uncertainty multiplied by a coverage factor  $k = 2$ , providing a level of confidence of approximately 95%.

Clause 5.5.3 of IEC 61331-1:2014 states that a relative standard uncertainty of 7% be taken into account in the decision of conformity in assigning the class of the Lead equivalent thickness to the material under test. If  $t_B$  is the standard Lead equivalent thickness class (0.25mm, 0.35mm, 0.5mm or 1mm) and  $\delta_B$  is the Lead equivalence of the material under test, the condition can be written as:

$$\delta_B \geq 0.93t_B$$

Reference: 2015050150\_4  
Checked by:

Page 3 of 3

NATIONAL PHYSICAL LABORATORY  
Continuation Sheet

CONDITIONS:

Distance from x-ray tube to target sample: 0.8m  
Ionisation chamber used: Radcal 10x5-60E s/n 9088

All equipment associated with the measurements performed in this report has direct traceability to UK national standards or UKAS accredited calibration facilities.

Table I  
61331-1:2014 X-ray beam qualities

X-ray Tube Voltage kV	Total filtration mmAl*
50	2.5
70	2.5
90	2.5
110	2.5
120	2.5
150	2.5

\*The inherent filtration of the x-ray tube was determined to be 0.3mmAl equivalent

Reference: 2015050150\_7  
Checked by: *[Signature]*

Page 2 of 3

NATIONAL PHYSICAL LABORATORY  
Continuation Sheet

CONDITIONS:

Distance from x-ray tube to target sample: 0.8m  
Ionisation chamber used: Radcal 10x5-60E s/n 9088

All equipment associated with the measurements performed in this report has direct traceability to UK national standards or UKAS accredited calibration facilities.

Table I  
61331-1:2014 X-ray beam qualities

X-ray Tube Voltage kV	Total filtration mmAl*
50	2.5
70	2.5
90	2.5
110	2.5
120	2.5
150	2.5

\*The inherent filtration of the x-ray tube was determined to be 0.3mmAl equivalent

Reference: 2015050150\_7  
Checked by: *[Signature]*

Page 2 of 3

NATIONAL PHYSICAL LABORATORY  
Continuation Sheet

RESULTS:

Attenuation = 1 - attenuated/un-attenuated x 100

Table II  
Bi-layer Low-Lead vinyl sheet, 0.35mm nominal Lead equivalent

kV	Equivalent Lead thickness mm	Attenuation %	PASS/FAIL
50	0.3317	99.6	PASS
70	0.3771	98.1	PASS
90	0.3814	95.6	PASS
110	0.3712	93.1	PASS
120	0.3628	91.9	PASS
150	0.3464	88.4	PASS

Table III  
Bi-layer Low-Lead vinyl sheet, 0.50mm nominal Lead equivalent (0.25mm double layer)

kV	Equivalent Lead thickness mm	Attenuation %	PASS/FAIL
50	0.5*	>99.9	
70	0.5727	99.4	PASS
90	0.5710	98.0	PASS
110	0.5394	96.5	PASS
120	0.5193	95.7	PASS
150	0.4840	93.3	PASS

\*The response of the ionisation chamber was too low to measure accurately. This value was extrapolated from a straight line fit of the 70-150kV qualities.

UNCERTAINTIES

The uncertainty in the Lead equivalence is ±5%. The reported expanded uncertainty is based on a standard uncertainty multiplied by a coverage factor  $k = 2$ , providing a level of confidence of approximately 95%.

Clause 5.5.3 of IEC 61331-1:2014 states that a relative standard uncertainty of 7% be taken into account in the decision of conformity in assigning the class of the Lead equivalent thickness to the material under test. If  $t_{pb}$  is the standard Lead equivalent thickness class (0.25mm, 0.35mm, 0.5mm or 1mm) and  $\delta_{IB}$  is the Lead equivalence of the material under test, the condition can be written as:

$$\delta_{IB} \geq 0.93t_{pb}$$

Reference: 2015050150\_7  
Checked by: *[Signature]*

Page 3 of 3



**CE 0338**

**Category III CE Mark**

Infab has been awarded the Quality Assurance Certificate MODULE D for X-ray radiation protective clothing and associated accessories. Certificate number 54067 was issued by BTTG™ for the notified body No. 0338 for regulation (EU) 2016/425. The Infab manufacturing facility was found to be in compliance with Module D "conformity to type based on quality assurance of the production process" of the Regulation.

View All Certificates at:  
<http://www.infabcorp.com/ce-mark/>





**Schedule of Approval**  
**Certificate Number: 54067**

First Issued: 14 August 2014 Page No: 3 of 3  
 Issue date: 04 December 2018 Issued by: BTTG™ (Notified Body No. 0338)  
 Expiry date: 14 August 2020 BTTG™ ref: E-003104

Manufacturer: Infab Corporation

Terms and Conditions associated with the issue of this Quality Assurance Certificate

1. This certificate is issued subject to BTTG™'s standard terms of business.
2. Production is limited to the site(s) listed above.
3. The client must implement appropriate changes as notified by BTTG™.
4. The client must ensure the certified product is representative of the ongoing manufactured product.
5. The client must:
  - a) Permit ongoing surveillance and access to documentation and records, and access to the relevant equipment, location(s), area(s), personnel and clients subcontractors.
  - b) Investigate complaints associated with the certified products. Records of such complaints, and actions taken, must be kept by the client and made available to BTTG™ when requested.
  - c) Allow participation of observers during surveillance audits when requested.
6. The client must only make claims consistent with the scope of certification,
7. The client must not make any misleading or unauthorised comments regarding the certified product or the certification body.
8. The client must upon suspension, withdrawal, or termination of certification discontinue the use of all advertising matter that contains any reference thereto and take action to return this certificate to BTTG™.
9. The client must comply with the requirements for the use of the notified body number as detailed below.
10. Changes to a client's product design, manufacturing processes, operations, location, management team or resource provision that could have an impact on the certified product shall be immediately notified to BTTG™.
11. This certificate is issued in the English language only. It is the responsibility of the Manufacturer / Authorised Representative to obtain and supply language versions acceptable to the country where the product is to be sold.
12. This certificate remains the property of BTTG™ and will be withdrawn if any of the conditions attached to its issue are not complied with.
13. The Manufacturer shall have continuous surveillance of Factory Production Control carried out by a Notified Body and a re-certification of Factory Production Control every three years.

Use of Notified Body Number

1. The Notified Body Number must only be used:
  - a) In direct association with products or systems covered by this Quality System Certificate.
  - b) By holder(s) of the Certificate.
2. Use of BTTG™ Notified Body Number does not extend to other companies which are:
  - a) part of the same corporate group as the Certificate holding company: or
  - b) named in a Certificate, for example as a supplier.
3. Particular care must always be taken to avoid the association of the BTTG™ Notified Body Number with other products or systems or schemes and with claims or information not contained in the BTTG™ document.
4. The EC mark consists of the letters 'CE', in the form given in Annex II of Regulation (EC) No. 765/2008, followed by BTTG™'s notified body number.

If any of the above requirements are not met BTTG™ will seek to suspend, withdraw or terminate this certificate.

END OF REPORT

BTTG™ & Shirley\* are trade names of Shirley Technologies Limited. Registered Office: Wira House, West Park Ring Road, Leeds, LS16 6QL. A company registered in England & Wales with company number 04669651. VAT Number GB816764800. Copyright © 2018 Shirley Technologies Limited. All rights reserved. PPE Module D Certificate v6 July 18



**Schedule of Approval**  
**Certificate Number: 54067**

First Issued: 14 August 2014 Page No: 2 of 3  
 Issue date: 04 December 2018 Issued by: BTTG™ (Notified Body No. 0338)  
 Expiry date: 14 August 2020 BTTG™ ref: E-003104

Manufacturer: Infab Corporation

BTTG™, specified as a "notified body" under the terms of the Regulation (EU) 2016/425 of the European Parliament and of the Council on personal protective equipment, did undertake the relevant quality assessment procedures for the manufacturing sites identified below, which were found to be in compliance with Module D "conformity to type based on quality assurance of the production process" of the Regulation, subject to any conditions in the schedule attached hereto.

This certificate authorises the use of the Mark of Conformity (the 'CE mark'), together with the number of the Notified Body involved in the production control phase (0338) once the manufacturer has issued a Declaration of Conformity according to Article 15 of the Regulation.

Places of Production

Infab Corporation  
 1040 Avenida Acaso  
 Camarillo  
 California  
 93012  
 USA

Technical Files / Models Approved

X-Ray radiation protection aprons and relate accessories made from various lead containing and lead-free sheets, singularly used or combined to obtain various "Lead Equivalence" protection values, including, but not limited to, the following products:

AWC, EBA, LSF, MAT-S1, WBT, SPL, SDO, SDA, CBV, SBC, TFA, LSW, FCW, MAT-FW, MWA, RVAS, VAS, EVAS, SKT, ESKT, RSKT, VST, EVKT, RVST, NST, TCV, SVT, REV-TC, LSC, HSV, ASB, PGS, GND, 399999, 400000, 400001, 400002, 400003, 400004, 400005, 400006, 400007, 400008, 400009, 400010, 400011, 400012, 683300, 7000165, 7000170, 700175, 700180, 700185, 700190, 735065, 735070, 735075, 735080, 735085, 735090, 775065, 775070, 775075, 775080, 775085, 775090

Approval Documents

Assessment Report: BTTG/KJW/Infab/04.2018

CONTINUED ON PAGE 3

BTTG™ & Shirley\* are trade names of Shirley Technologies Limited. Registered Office: Wira House, West Park Ring Road, Leeds, LS16 6QL. A company registered in England & Wales with company number 04669651. VAT Number GB816764800. Copyright © 2018 Shirley Technologies Limited. All rights reserved. PPE Module D Certificate v6 July 18



## Certification to ISO 13485:2016

### The Highest Standard of Excellence in Medical Device Quality Management Systems Certification

Perry Johnson Registrars, Inc., an accredited certification body, has audited the Quality Management System for INFAB and granted certification to ISO 13485:2016 for the following scope: "Manufacture and design and development of radiation protective apparel, accessories, barriers, apron racks and gloves and distribution of glasses."

We look forward to maintaining this certification and to continue to provide the best, highest quality radiation protection products on the market.

# FDA

Establishment Registration & Device Listing:  
 INFAB CORP.  
 1040 Avenida Acaso  
 Camarillo, CA 93012  
 Registration Number: 2024351

Date of Registration Status: 2017  
 Owner/Operator:  
 INFAB CORP.  
 1040 Avenida Acaso  
 Camarillo, CA 93012

Owner/Operator Number: 2024351  
 Official Correspondent:  
 Don J Cusick  
 1040 Avenida Acaso  
 Camarillo, CA 93012  
 Phone: 805-987-5255 x106

## FDA Certificate

Device Classification Name:	Shield, protective, personnel
510(k) Number	K896289
Device Name	RADIATION PROTECTION APRON
Applicant	INFAB CORP. 1040 Avenida Acaso Camarillo, CA 93012
Contact	Don Cusick
Regulation Number	892.6500
Classification Product Code	KPY
Date Received	10/31/1989
Decision Date	12/14/1989
Decision	Substantially equivalent (SE)
Classification Advisory Committee	Radiology
Review Advisory Committee	Radiology
Statement/Summary/Purged Status	Purged, no summary or statement
Type	Traditional
Reviewed by Third Party	No

## 510(k) Premarket Notification

Proprietary Name	Non leaded apron; Greenlite®
Classification Name	Apron, non leaded
Product Code	EAJ
Device Class	1
Regulation Number	892.6500
Medical Specialty	Radiology
Registered Establishment Name	Infab Corp.
Registered Establishment Number	2024351
Owner/Operator	Infab Corp.
Owner/Operator Number	2024351
Review Advisory Committee	Radiology
Establishment Operations:	Manufacturer



## TERMS & CONDITIONS

1. **PRICING, DELIVERY AND PAYMENT.** The prices for Product delivered under this Order do not include customs charges or duties, or sales, use, excise or similar taxes, or special packaging, or transportation, rigging, drayage, insurance charges and other costs associated with the delivery of Product to the destinations specified by the Customer unless specifically set out on the invoice as individual line items. Therefore Customer will pay directly to Seller ("Seller"), in addition to the prices specified in this Order, any amount set forth on Seller's invoices for customs charges, duties and/or taxes (or provide applicable tax exemption certificates acceptable to the taxing authorities) and special packaging costs, and shall pay directly to the involved carrier(s) all such delivery related costs. All licenses or certificates required for import or export of the Product shall be the responsibility of and obtained at the cost of Customer. Seller's terms are cash upon delivery, unless otherwise set forth in a distribution or reseller agreement. If credit terms are approved by Seller, Customer shall pay all invoices net thirty (30) days after date of shipment. If payment is not made when due, Customer shall be assessed a late charge equal to one and one-half percent (1-1/2%) of the past due balance for each month or partial month following the due date. Additionally, at seller's discretion, all discounts shall be removed and any amounts due shall be the current list price of such items, regardless of any other agreement or discount offered. All deliveries shall be made F.O.B. common carrier, Seller's plant. Title and risk of loss or damage will transfer from Seller to Customer upon delivery of goods at the F.O.B. point. Customer shall notify Seller, in writing, within one (1) calendar day after delivery, of any claimed shortages, damage or of rejection of the delivery. Sufficient detail to establish grounds shall be included in any rejection.

2. **PRODUCT SAMPLES.** Product samples will be provided to licensed distributors of Seller's product. Upon termination of a distribution arrangement, distributor shall return to Seller, at distributor's expense, all samples previously provided to distributor by Seller in resalable as new condition. For any goods not returned in accordance with the above, Distributor will be invoiced for sample product at the same discount established for distributor for production goods. If invoice is not paid within 10 days of receipt, all discounts will be canceled and prices for samples will revert to full List Price.

3. **SECURITY INTEREST.** Seller reserves, until full payment is received, a Purchase Money Security

Interest in each Product Unit and the proceeds of any sale thereof. A copy of this Order may be filed as a Financing Statement with the appropriate state authorities to perfect the security interest of Seller.

4. **CANCELLATION OF PRODUCT.** Customer hereby acknowledges and agrees that all Product is custom manufactured for each individual Customer and once production has commenced there can be no cancellation of orders.

5. **TERMINATION.** This Order may be terminated by either party at any time: (a) if the other party has breached any material provision contained in this Order and has not cured the breach within thirty (30) days of receipt of written notice of the breach; or (b) if the other party petitions for relief under the Bankruptcy Act, if a receiver is appointed to conduct its business, if its makes an assignment for the benefit of creditors or if an involuntary bankruptcy petition is brought against it and has not been discharged within 30 days of date brought. Seller termination of this Order shall be without prejudice to any other remedies Seller may have. In the event Seller terminates this Order pursuant to Article 4, in addition to any other remedies available to Seller, Customer shall be obligated to pay for all Product shipped and shall accept delivery of and pay for all Product on order as of the date of termination. Customer's obligation to pay all charges accrued as of the termination hereof shall survive such termination.

6. **GENERAL PROVISIONS.** These terms and conditions shall supersede all terms and conditions printed or implied on any purchase order issued by Customer. No other terms or conditions shall be binding upon Customer or Seller unless said terms and conditions are specifically accepted in writing by Customer and Seller. The failure of Customer or Seller to enforce at any time or for any period of time any of the provisions of this Order shall not constitute a waiver of such provisions. Seller shall not be liable for delays or failure to ship for causes beyond Seller's control, affecting it or its suppliers, including, in part: natural disasters; war; Customer's conduct; labor unrest; riot; governmental interference; unavailability or shortage of labor, materials, fuel or power through customary means at normal rates; failure or destruction of plant or equipment arising from any cause whatsoever; or failure of transportation. If any provision of this Order should be determined to be unenforceable or illegal, it shall be deemed severable from the other provisions, which shall remain valid and enforceable. The validity, performance and construction of this Order shall be governed by the laws of the state of California. Customer agrees to accept venue in, and accept the exclusive jurisdiction of, the courts sitting in the state of California. Any disputes arising out of the performance of this Order shall be settled in accordance with the rules of the American Arbitration Association. The arbitrator may award all costs of dispute resolution, including attorneys' fees, to the prevailing party. Seller

agrees that the Product to be furnished under this Order was produced in compliance with all applicable federal requirements with respect to fair labor standards and equal employment opportunity.

7. **LIMITED WARRANTY ON PRODUCT.** Seller warrants that all Products are warranted to be free of defects in material and workmanship for a period of two (2) years from the date of shipment. Products returned under the above warranty shall be either repaired or replaced at the sole discretion of Infab Corporation, and is limited to the value of the Products on the date of the original shipment. All replaced parts and Product become the property of Seller. This limited warranty does not include service to repair damage to the Product resulting from customer's negligence, misuse, modification of the Product, or use for purposed other than those intended by its manufacture. Does not cover excessive use or wear and tear from improper storage or customer abuse or failure to follow proper care guidelines. Warranty is voided if any solvent based cleaning solutions are used. Seller's obligations under this limited warranty are conditioned upon Customer's compliance with Seller's reasonable instructions and requests in connection with its performance of such obligations. Service under this limited warranty may be obtained by delivering the Product at Customer's expense (using the original shipping container or its equivalent) during the warranty period to the manufacturer and providing proof of purchase date. Customer shall assume the risk of loss or damage in transit. Seller shall bear the cost for return of repaired or replaced Product under valid warranty claims to Customer by normal commercial means in the continental United States. For further information, refer to the Limited Warranty contained in Seller's standard product literature, if applicable.

**NOTE:** All aprons must be inspected by the facility before they are put into service. No returns for aprons with alleged pinholes, tears, or cracks will be allowed more than seven (7) days after the aprons have been received by the end user. Protective core material is fragile, easily damaged and therefore great care is needed to protect the integrity of the core material. All aprons are inspected and free of defects when they are shipped. Pinholes, tears, cracks and other damage to the protective core material can be caused by many different factors, but if they are not there when the apron is received and inspected, then they are not the responsibility of the manufacturer and the warranty does not apply.

**EXCEPT AS SET FORTH HEREIN AND IN THE LIMITED WARRANTY INCLUDED IN SELLER'S STANDARD PRODUCT LITERATURE, IF APPLICABLE, SELLER HEREBY DISCLAIMS ALL OTHER WARRANTIES, EXPRESS OR IMPLIED, ARISING OUT OF OR IN CONNECTION WITH THE SALE OR USE OF THE EQUIPMENT, INCLUDING, BUT NOT LIMITED TO, THE IMPLIED WARRANTIES OF MERCHANTABILITY AND FITNESS FOR A PARTICULAR PURPOSE. OTHER**

**THAN AS STATED ABOVE THE LIMITED WARRANTY SET FORTH IN THIS SECTION, COMBINED WITH THE LIMITED WARRANTIES CONTAINED IN SELLER'S STANDARD PRODUCT LITERATURE, IF APPLICABLE, SHALL CONSTITUTE THE SOLE AND EXCLUSIVE REMEDY OF CUSTOMER AND SHALL ESTABLISH THE SOLE AND EXCLUSIVE LIABILITY OF SELLER, ITS SUCCESSORS OR ASSIGNS IN CONNECTION WITH THE PRODUCT. IN NO EVENT WILL SELLER BE LIABLE TO CUSTOMER FOR ANY DAMAGES, INCLUDING SPECIAL, INCIDENTAL OR CONSEQUENTIAL DAMAGES, ARISING OUT OF THE USE OR INABILITY TO USE SUCH PRODUCT, EVEN IF SELLER HAS BEEN ADVISED OF THE POSSIBILITY OF SUCH DAMAGES, OR ANY CLAIM BY ANY OTHER PARTY. SOME STATES DO NOT ALLOW THE LIMITATION OR EXCLUSION OF IMPLIED WARRANTIES OR OF LIABILITY FOR SPECIAL OR CONSEQUENTIAL DAMAGES, SO THE ABOVE LIMITATION OR EXCLUSION MAY NOT APPLY TO YOU. SOME STATES DO NOT ALLOW THE LIMITATION OF LIABILITY OR THE EXCLUSION OF IMPLIED WARRANTIES, SO THE ABOVE LIMITATIONS AND EXCLUSIONS MAY NOT APPLY AND CUSTOMER MAY ALSO HAVE OTHER RIGHTS WHICH VARY FROM STATE TO STATE.**

8. **DAMAGE IN SHIPMENT.** The packaging of Infab products meets or exceeds all requirements of the Consolidated Freight Classifications. However, all packages should be checked immediately upon arrival at Customer's facility. Should any concealed damage be suspected the Customer shall note it on the Bill of Lading when received. If any concealed damage is discovered, place a hold the shipping container and contact the carrier to schedule an inspection. Any claim must be made directly to the carrier within 24 to 48 hours of merchandise or the claim may not be allowed. Any claim for damage must be made directly with the carrier. Infab cannot file a claim in the name of or for the benefit of the Customer. Failure to follow this exact procedure could invalidate your claim.

9. **DELIVERY.** All stock items are shipped from our warehouse the same day if P.O. is received before noon. Otherwise it will ship next day. Non-stock or custom items (such as modified or special size aprons and/or monogramming) are shipped within 7 to 10 days of our receipt of your completed order. All special services such as UPS Blue or Red, Fed-Ex, Airborne, etc. can be accommodated at actual cost.

10. **MINIMUM ORDERS.** There is a \$100.00 minimum per purchase order.

11. **EXCHANGES OR RETURNS.** Exchanges or Returns must have prior approval by notifying us within 5 days of receipt of the order whether shipped direct to you or drop shipped to your customer. All returns must be sent in their original packaging. A 20% restock charge plus all freight charges including the outbound and return freight will be due and payable. Custom items such as special sized aprons, monogrammed aprons or a product with any modification are not returnable. This includes barriers or racks in any other color except our standard Medical White.



**If you have any questions about  
choosing the right radiation  
protection garment for you, please  
*contact us*  
for a *free consultation.***

**805-987-5255**

M-F 6:30am-5pm PDT

[info@infabcorp.com](mailto:info@infabcorp.com)

[www.InfabCorp.com](http://www.InfabCorp.com)



# INFAB

TRANSPARENCY IN RADIATION PROTECTION

Contact Us  
M-F 6:30am-5pm PDT  
[info@infabcorp.com](mailto:info@infabcorp.com)  
[www.InfabCorp.com](http://www.InfabCorp.com)

Infab Corporation  
1040 Avenida Acaso  
Camarillo, CA, USA 93012  
Phone: 805-987-5255  
Fax: 805-482-8424

CE 0338

