

INFAB

2023
CATALOG



Table of Contents

About Infab	3
Core Material	4
Revolution Aprons	6
Classic Aprons	26
Lightning Aprons	48
Smart Track	50
Accessories	52
Disposables–Casette Covers.....	61
Disposables–Scatter Armor.....	64
Disposables–C-Arm Drapes.....	66
Glasses	70
Gloves	93
Barriers	198
Apron Racks	112
Curtains	123
Patient	129
Certification.....	132
Terms & Conditions	133

Connect with Us

INFAB has established itself as a global company. Reach us anywhere around the world for the best radiation protection.

Connect with us through social media:



View our Channel on YouTube

YouTube.com/Infabcorp



Join us on Twitter

Twitter.com/Infabcorp



Link with us on LinkedIn

LinkedIn.com/company/infab-corporation



Follow us on Instagram

Instagram.com/Infabcorp



Connect with us on Facebook

Facebook.com/Infabcorp

** Product availability and details may change at any time. For current information and availability, please view our online catalog at <https://www.infabcorp.com/catalog>.*

Welcome to INFAB

INFAB enables health care providers and patients to apply and benefit from imaging technology's diagnostic capabilities with the peace of mind that comes from knowing they are protected by the best-engineered garments, eyewear, and protective barriers in the world.

INFAB designs and builds the world's lightest weight, most comfortable and technologically advanced radiation attenuation products with the highest protection levels of any manufacturer.

Reach out to our Sales Team

Monday - Friday: 6:30 AM - 5 PM (PT)

Number: (805) 987-5255

Email: info@infabcorp.com

www.INFABCORP.com





KIARMOR™ BI-LAYER MATERIAL

The World's Most Advanced Certified Radiation Protection Core Material

KIARMOR is the only lead-free material that passes all three universally recognized testing procedures:

- ASTM F2547-18
- IEC 61331-1:2014
- DIN 6857-1



Tested & Certified Against 50 kVp to 150 kVp

KIARMOR Bi-Layer is tested and certified for attenuation and lead equivalence by the National Physical Laboratory (NPL) against a full range of radiation qualities 50 kVp to 150 kVp using the broad beam geometry method.





2 Individual Layers Within 1 Homogenous Material

KIARMOR takes advantage of the physics associated with using individual layers of specific materials to provide maximum attenuation by eliminating the effects of fluorescence.



Sb	Antimony	51 (Low atomic weight element)
Bi	Bismuth	83 (High atomic weight element)

Radiation Protection CORE Material	Materials	Lead Equivalency	Attenuation						Core Weight Lb/Ft ² (of core in apron)	Core Weight KG/m ² (area density)	Front Protection Male Medium Apron Weight 303M-M
			50 kVp	70 kVp	90 kVp	110 kVp	120 kVp	150kVp			
 <p>KIARMOR Lead-Free is the lightest weight protection offered. It is the only lead-free material that passes all 3 universally recognized testing procedures: ASTM F2547-18, IEC 61331-1:2014, DIN 6857-1</p>	Antimony, Bismuth One Homogeneous Layer	.25mm LE	98.7%	96.1%	92.0%	87.8%	85.8%	80.1%	0.522	2.55	3.85 Lbs.
		.35mm LE	99.6%	98.0%	95.3%	92.7%	91.5%	88.1%	0.729	3.56	5.0 Lbs.
		.5mm LE	99.9%	99.4%	97.8%	96.3%	95.5%	93.0%	1.042	5.09	6.95 Lbs.
 <p>Our Lightweight Lead core material passes all 3 universally recognized testing procedures: ASTM F2547-18, IEC 61331-1:2014, DIN 6857-1</p>	Lightweight Lead	.25mm LE	98.8%	95.1%	90.7%	87.5%	86.2%	82.7%	0.622	3.04	4.35 Lbs
		.35mm LE	99.7%	97.6%	94.5%	92.3%	91.3%	88.6%	0.872	4.26	6.15 Lbs
		.5mm LE	99.9%	99.1%	97.4%	96.1%	95.5%	93.0%	1.245	6.08	8.0 Lbs

For over 40 years INFAB has been a leader in providing our customers with new and innovative products to protect against harmful radiation. We believe our customers have the right to be educated about precisely what is in their radiation protection aprons. We offer a simple two core material line: KIARMOR Lead Free and Lightweight Lead.

Every core material option provides complete attenuation between 50 and 150 kVp. INFAB has dedicated countless hours into the research and development of the best materials to keep customers safe. We urge you to always ask for testing results as a basis of comparison. INFAB KIARMOR offers the lightest material that passes all international protection standards.

REVOLUTION

Key Features



Smart Track



Abrasion Resistant



Flame Resistant



Water Resistant



Bacteria Resistant



Cool wear



Monograms can be added either in "Block" or "Script" to any INFAB Aprons

How to Measure for Your New Apron

- Take all measurements with a cloth measuring tape.
- Measurements should be taken over your clothing.
- Do not attempt to take your own measurements. You should request the help of an assistant for best accuracy.
- Refer to the Find Your Size diagram for proper location of measurements.
- Some apron patterns are cut for specific genders. In these instances, if users of various genders will be sharing aprons, plan to consider male size options. If aprons are being purchased for separate gender use, plan to select the specific gender of the wearer(s) to ensure the best protection/fit.
- Once all measurements have been taken, refer to our sizing chart to find your size.
- If it is determined that a user is between sizes, consider the larger size. Garments that are too big may be made smaller; however, garments that are too small cannot be made larger.

The Tools You Will Need

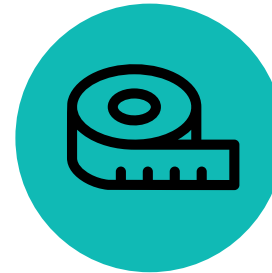

Cloth Measuring Tape



Pencil & Paper



Measuring Assistant

Find Your Size

Available Length Alteration of (±2" or ±4")

Revolution Vest Length (*)

Location	xSmall, Small, Medium, Large, xLarge	2xLarge
Front	22" / 56 cm	24" / 61 cm
Back	26" / 66 cm	28" / 66 cm

Revolution Skirt Length (*)

Location	xSmall, Small, Medium, Large, xLarge, 2xLarge
Wraparound	22" / 56 cm

Revolution Front Panel Apron Length (*)

Location	xSmall, Small, Medium, Large, xLarge, 2xLarge
Front	38" / 97 cm

Revolution Full Wrap Apron Length (*)

Location	xSmall, Small, Medium, Large, xLarge, 2xLarge
Wraparound	38" / 97 cm

Revolution 903 Vest Sizing

Location	xSmall	Small	Medium	Large	xLarge	2xLarge
Chest (C)	30-32" / 76-81 cm	35-36" / 89-91 cm	37-38" / 94-97 cm	39-40" / 99-102 cm	41-42" / 104-107 cm	43-44" / 109-112 cm
Length (L)	21" / 53 cm	21.5" / 55 cm	22" / 56 cm	22.5" / 57 cm	23" / 58 cm	23.5" / 60 cm

Revolution 903 Skirt Sizing

Location	xSmall	Small	Medium	Large	xLarge	2xLarge
Waist (W)	25-27" / 64-67 cm	28-30" / 71-76 cm	31-33" / 79-84 cm	34-36" / 86-91 cm	37-39" / 94-99 cm	40-42" / 102-107 cm
Length (L)	22" / 56 cm	22" / 56 cm	22" / 56 cm	22" / 56 cm	23" / 58 cm	23" / 58 cm

603 Unisex Sizing

Location	xSmall	Small	Medium	Large	xLarge	2xLarge
Chest (C)	30-33" / 76-84 cm	34-37" / 86-94 cm	38-41" / 97-104 cm	42-45" / 107-114 cm	46-49" / 117-125 cm	50-52" / 127-132 cm
Waist (W)	25-27" / 64-67 cm	28-31" / 71-79 cm	32-35" / 81-89 cm	36-39" / 91-99 cm	40-43" / 102-109 cm	44-46" / 112-117 cm

UNISEX SIZING

SPECIAL SIZING

If you see these icons, it means that the apron has its own unique measurements.

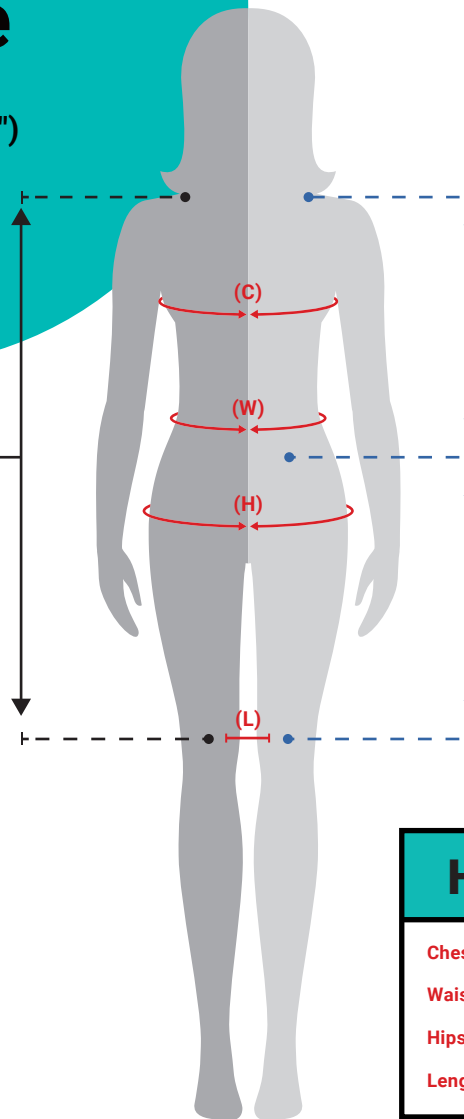

Measure from high point shoulder to about 1" above the knee. This will be your one piece apron length.

Measure from high point shoulder to desired skirt belt line. Then add 4" to find your vest length.

Measure from your desired skirt belt line to about 1" above the knee. This will be your skirt length.

HELPFUL HINTS

Chest (C): Measure widest part 1" below armhole.

Waist (W): Measure narrowest part 1" above navel.

Hips (H): Measure widest part of hips.

Length (L): We recommend 1" above the knee.

Female Measurements (Applies to All *)

Location	xSmall	Small	Medium	Large	xLarge	2xLarge
Chest (C)	30-32" / 76-81 cm	33-36" / 84-91 cm	37-39" / 94-99 cm	40-42" / 102-107 cm	43-45" / 109-114 cm	46-48" / 117-122 cm
Waist (W)	25-27" / 64-67 cm	28-30" / 71-76 cm	31-33" / 78-84 cm	34-36" / 86-91 cm	37-39" / 94-99 cm	40-42" / 102-107 cm

Contact us for sizes above 2XL

Find Your Size

Available Length Alteration of (±2" or ±4")

UNISEX SIZING

SPECIAL SIZING

If you see these icons, it means that the apron has its own unique measurements.

Measure from high point shoulder to desired skirt belt line. Then add 4" to find your vest length.

Measure from your desired skirt belt line to about 1" above the knee. This will be your skirt length.

Measure from high point shoulder to about 1" above the knee. This will be your one piece apron length.

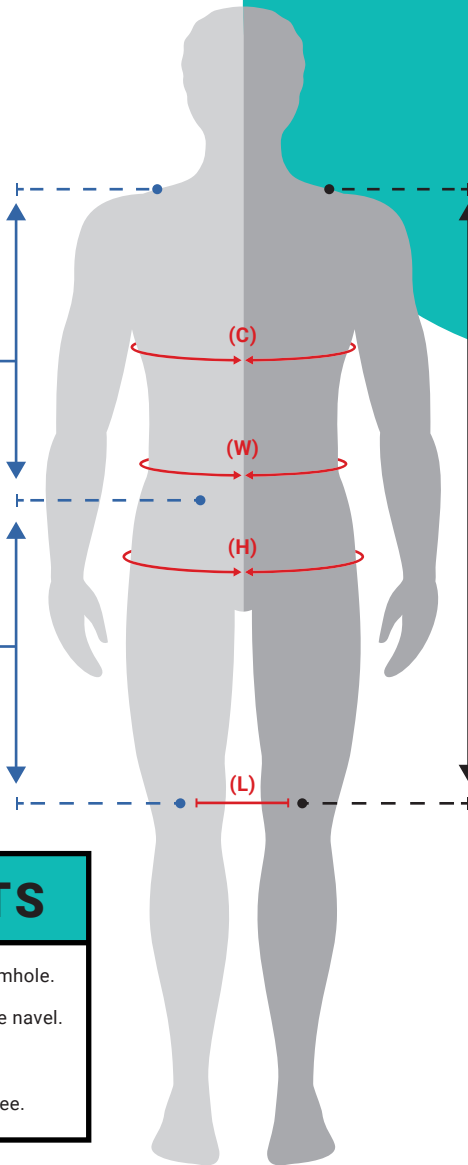

HELPFUL HINTS

- Chest (C):** Measure widest part 1" below armhole.
- Waist (W):** Measure narrowest part 1" above navel.
- Hips (H):** Measure widest part of hips.
- Length (L):** We recommend 1" above the knee.

Male Measurements (Applies to All *)

Location	Small	Medium	Large	xLarge	2xLarge
Chest (C)	34-37" / 86-94 cm	38-41" / 97-104 cm	42-45" / 107-114 cm	46-49" / 117-125 cm	50-52" / 127-132 cm
Waist (W)	28-31" / 71-79 cm	32-35" / 81-89 cm	36-39" / 91-99 cm	40-43" / 102-109 cm	44-46" / 112-117 cm

Contact us for sizes above 2XL

Revolution Vest Length (*)

Location	xSmall, Small, Medium, Large, xLarge	2xLarge
Front	24" / 61 cm	26" / 66 cm
Back	28" / 71 cm	30" / 71 cm

Revolution Skirt Length (*)

Location	xSmall, Small, Medium, Large, xLarge, 2xLarge
Wraparound	22" / 56 cm

Revolution Front Panel Apron Length (*)

Location	xSmall, Small, Medium, Large	xLarge	2xLarge
Front	38" / 97 cm	42" / 107 cm	44" / 112 cm

Revolution Full Wrap Apron Length (*)

Location	xSmall, Small, Medium, Large, xLarge, 2xLarge
Wraparound	38" / 97 cm

Revolution 903 Vest Sizing

Location	xSmall	Small	Medium	Large	xLarge	2xLarge
Chest (C)	35-36" / 89-91 cm	37-38" / 94-97 cm	39-40" / 99-102 cm	41-42" / 104-107 cm	43-44" / 109-112 cm	45-46" / 114-117 cm
Length (L)	23.5" / 53 cm	24.5" / 62 cm	25" / 63.5 cm	25.5" / 65 cm	26" / 66 cm	26.5" / 67 cm

Revolution 903 Skirt Sizing

Location	xSmall	Small	Medium	Large	xLarge	2xLarge
Waist (W)	24-27" / 61-69 cm	28-31" / 71-79 cm	32-35" / 81-89 cm	36-39" / 91-99 cm	40-43" / 102-109 cm	44-46" / 112-117 cm
Length (L)	22" / 56 cm	22" / 56 cm	22" / 56 cm	22" / 56 cm	23" / 58 cm	23" / 58 cm

603 Unisex Sizing

Location	xSmall	Small	Medium	Large	xLarge	2xLarge
Chest (C)	30-33" / 76-84 cm	34-37" / 86-94 cm	38-41" / 97-104 cm	42-45" / 107-114 cm	46-49" / 117-125 cm	50-52" / 127-132 cm
Waist (W)	25-27" / 64-67 cm	28-31" / 71-79 cm	32-35" / 81-89 cm	36-39" / 91-99 cm	40-43" / 102-109 cm	44-46" / 112-117 cm

Core Material Configurations



Overlapping Sections



Non-Overlapping Sections



Overlapping LE #



Non-Overlapping LE #

PARTIAL OVERLAP

REVOLUTION Vests and Full Wrap Aprons *DO NOT REQUIRE* a full overlap to achieve the stated protection level shown. Skirt Aprons *REQUIRE* a full overlap to achieve the stated protection level shown.

REVOLUTION: 103, B103, L103, BL103

REVOLUTION: 203, B203

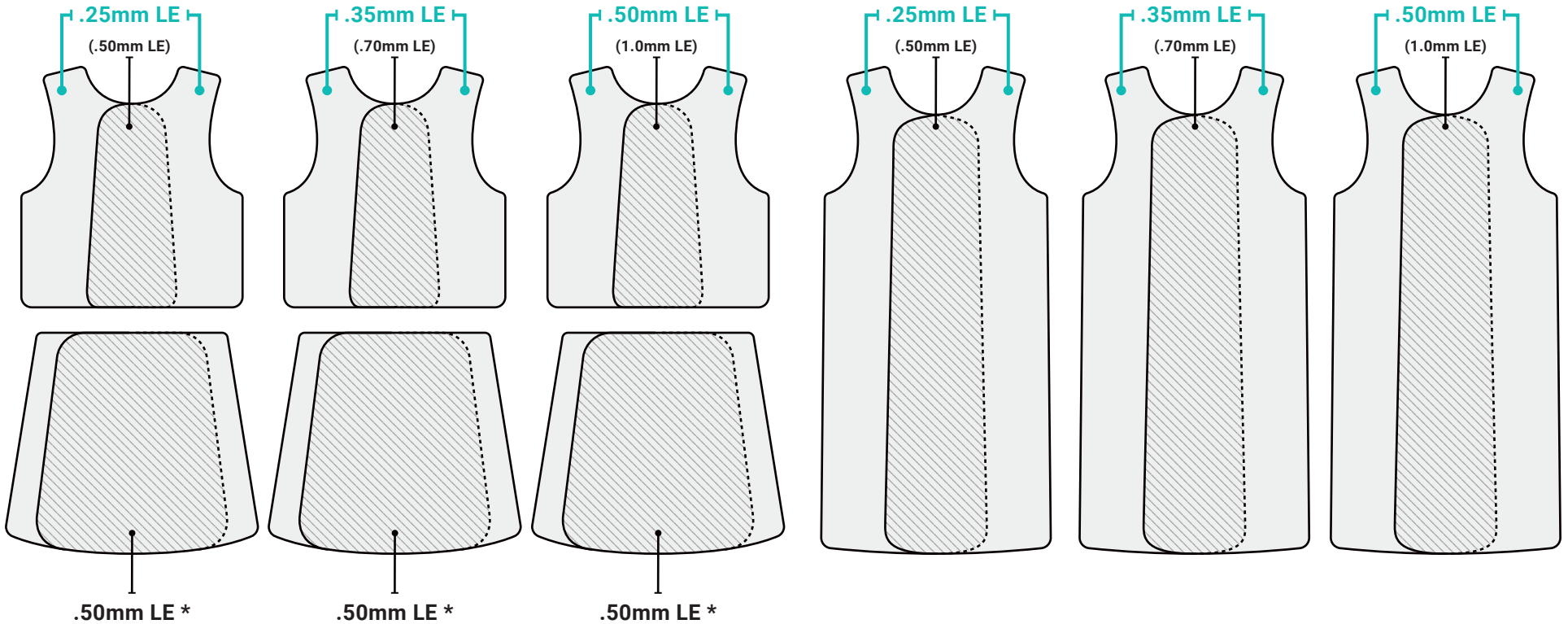

All non-overlapping skirt sections are .25mm LE *

(These overlapping sections are extra protection)

Core Material Configurations



Overlapping Sections



Non-Overlapping Sections



Overlapping LE #



Non-Overlapping LE #

NO OVERLAP

REVOLUTION Front Wrap Aprons achieve the stated protection level shown.

REVOLUTION: 303, B303, 403, B403, 503, B503, 603, B603

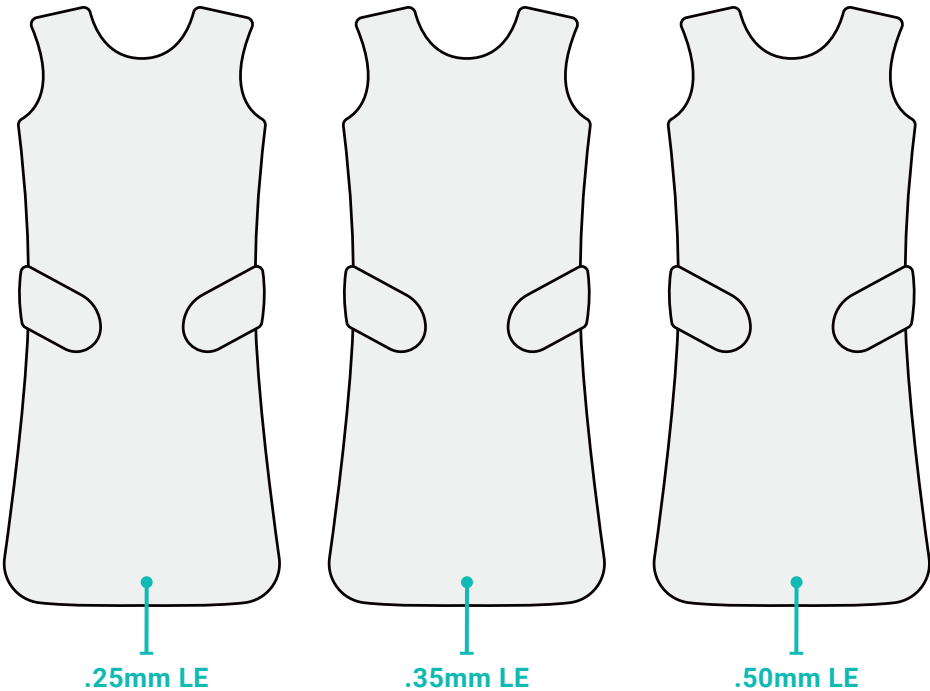

FULL OVERLAP

REVOLUTION 703 and 803 Aprons *REQUIRE* a full overlap to achieve the stated protection level shown.

REVOLUTION: 703, 803

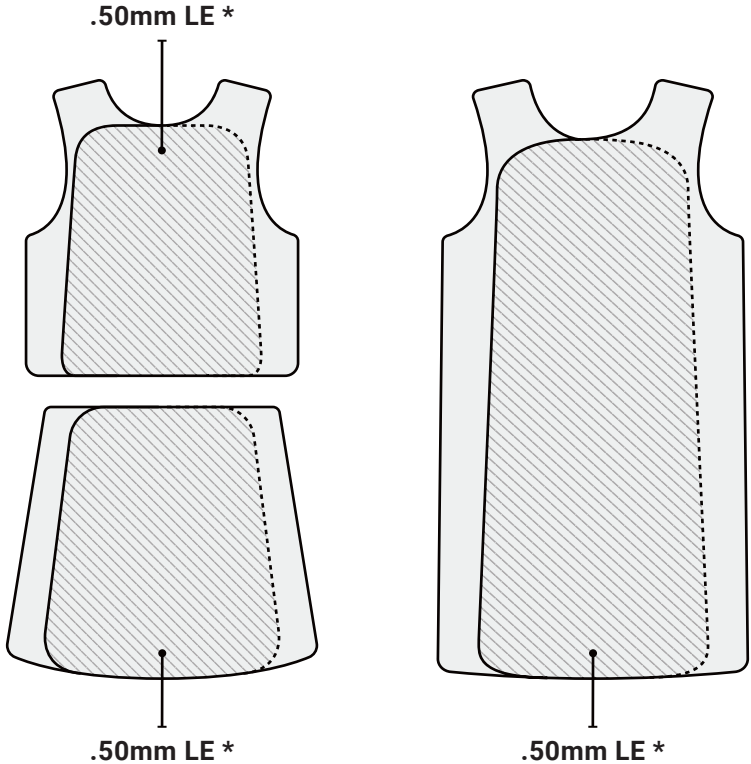

The 603 and B603 back panels are .25mm LE

All non-overlapping sections are .25mm LE *

103 & L103

Revolution Vest and Skirt &
Revolution Lumbar Vest and Skirt

The Revolution Vest and Skirt apron provides maximum weight distribution between the shoulders and hips, reducing stress on the upper and lower back. The vest is a partial overlap and offers full front and back protection. The L103 includes a Snap-on, fully adjustable lumbar Black Belt®. SmartTrack enabled.

- SIZE:** xSmall - 2xLarge (Pages 8-9)
- FABRIC:** Revolution Fabric with Cool Wear
- PROTECTION:** .25mm LE, .35mm LE, and .50mm LE
- CORE:** Lightweight Lead or KIARMOR Lead-Free
- COLOR:** 500, 600, 700, 800, 900, and Remix series (Pages 22-24)
- BASE FABRIC:** Nylon fabric with limited color options (Page 21)



The Vest: Inside are two slits that allow the lumbar belt to slide through the garment.



203

Revolution Full Wrap Black Belt

The Revolution Full Wrap Black Belt apron offers maximum protection with partial overlap. This apron combines comfort with superior lumbar support, which reduces fatigue and upper back stress during lengthy procedures. Built-in slits on each side with hook and loop closures provide increased mobility. The 203 features a snap-on, fully adjustable lumbar Black Belt® for superior back support. SmartTrack enabled.

- SIZE:** xSmall - 2xLarge (Pages 8-9)
- FABRIC:** Revolution Fabric with Cool Wear
- PROTECTION:** .25mm LE, .35mm LE, and .50mm LE
- CORE:** Lightweight Lead or KIARMOR Lead-Free
- COLOR:** 500, 600, 700, 800, 900, and Remix series (Pages 22-24)
- BASE FABRIC:** Nylon fabric with limited color options (Page 21)



Shown: Hook & Loop Closure Side Slits



Model: 203 Color Shown: 602

303

Revolution Front

This Revolution Front apron offers radiation protection to the front side of the body. This lead apron features a hook-and-loop closure at the waist, which relieves weight from the shoulders and adjusts for the most comfortable fit. SmartTrack enabled.

- SIZE:** xSmall - 2xLarge (Pages 8-9)
- FABRIC:** Revolution Fabric with Cool Wear
- PROTECTION:** .25mm LE, .35mm LE, and .50mm LE
- CORE:** Lightweight Lead or KIARMOR Lead-Free
- COLOR:** 500, 600, 700, 800, 900, and Remix series (Pages 22-24)
- BASE FABRIC:** Nylon fabric with limited color options (Page 21)



Shown:
Cross Hatch Straps with
Hook & Loop Closures

403

Revolution Front Elastic Back

The Revolution Front Elastic Back is designed to protect the front side of the body. The elastic back straps with waist hook-and-loop closures enhance comfort and flexibility. SmartTrack enabled.

- SIZE:** xSmall - 2xLarge (Pages 8-9)
- FABRIC:** Revolution Fabric with Cool Wear
- PROTECTION:** .25mm LE, .35mm LE, and .50mm LE
- CORE:** Lightweight Lead or KIARMOR Lead-Free
- COLOR:** 500, 600, 700, 800, 900, and Remix series (Pages 22-24)
- BASE FABRIC:** Nylon fabric with limited color options (Page 21)



Shown:
Elastic Straps with
Hook & Loop Closures

503

Revolution Front Black Belt

The Revolution Front Black Belt provides frontside body protection while offering snap-on, fully adjustable Black Belt® lumbar support. The built-in back strap provides better weight distribution between the shoulders and waist. SmartTrack enabled.

- SIZE:** xSmall - 2xLarge (Pages 8-9)
- FABRIC:** Revolution Fabric with Cool Wear
- PROTECTION:** .25mm LE, .35mm LE, and .50mm LE
- CORE:** Lightweight Lead or KIARMOR Lead-Free
- COLOR:** 500, 600, 700, 800, 900, and Remix series (Pages 22-24)
- BASE FABRIC:** Nylon fabric with limited color options (Page 21)



Shown:
Unique cross straps with
Hook & Loop Closures

603

Revolution Full Wrap Elastic Back

The Revolution Full Wrap Elastic Back apron offers maximum front and back protection. The elastic back helps enhance comfort and provides superior lumbar support. Hook-and-loop closures at the waist relieve weight from the shoulders, while the top adjustable strap provides a precise fit. SmartTrack enabled.

- SIZE:** xSmall - 2xLarge (Pages 8-9)
- FABRIC:** Revolution Fabric with Cool Wear
- PROTECTION:** .25mm LE, .35mm LE, and .50mm LE
- CORE:** Lightweight Lead or KIARMOR Lead-Free
- COLOR:** 500, 600, 700, 800, 900, and Remix series (Pages 22-24)
- BASE FABRIC:** Nylon fabric with limited color options (Page 21)



Shown: Elastic back helps secure a proper fit

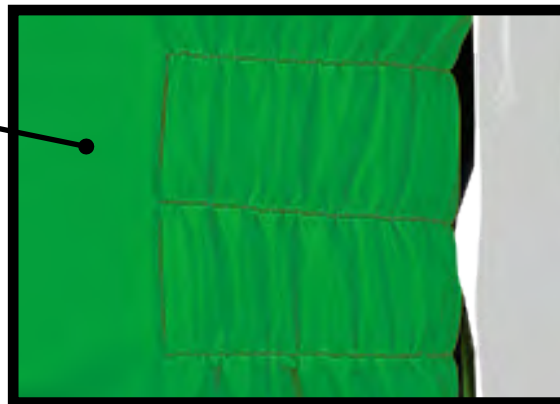

UNISEX
SIZING

The back panels of the 603/B603 are .25mm LE *



Model: 603 Color Shown: 612

703

Revolution Full Overlap Lumbar Vest & Skirt

The Revolution Full Overlap Lumbar Vest & Skirt features full overlap protection and a Black Belt® for additional lumbar support. This apron is lightweight, offering maximum protection with a Classic fit. SmartTrack enabled.

- SIZE:** xSmall - 2xLarge (Pages 8-9)
- FABRIC:** Revolution Fabric with Cool Wear
- PROTECTION:** .50mm LE
- CORE:** Lightweight Lead or KIARMOR Lead-Free
- COLOR:** 500, 600, 700, 800, 900, and Remix series (Pages 22-24)
- BASE FABRIC:** Not available in this model



Shown: KTC Buckle to keep belt attached and in place



Shown: Color block inside panel of the skirt

The Vest: Inside are two slits that allow the lumbar belt to slide through the garment.

All non-overlapping sections are .25mm LE *

803

Revolution Black Belt Wrap

The Revolution Black Belt Wrap apron offers full overlap protection, providing superior lumbar support with a Classic fit. Built-in slits on each side with hook and loop closures provide increased mobility. SmartTrack enabled.

- SIZE:** xSmall - 2xLarge (Pages 8-9)
- FABRIC:** Revolution Fabric with Cool Wear
- PROTECTION:** .50mm LE
- CORE:** Lightweight Lead or KIARMOR Lead-Free
- COLOR:** 500, 600, 700, 800, 900, and Remix series (Pages 22-24)
- BASE FABRIC:** Not available in this model



Shown:
Hook & Loop
Closure Side Slits



All non-overlapping sections are .25mm LE *

Model: 803 Color Shown: Remix

903

Revolution Reverse Vest and Skirt

SPECIAL SIZING

The Revolution Reverse Vest and Skirt apron provides maximum weight distribution. Criss-cross elastic back straps provide weight relief and lumbar support, while the adjustable shoulder strap ensures a precise fit. SmartTrack enabled.

- SIZE:** xSmall - 2xLarge (Pages 8-9)
- FABRIC:** Revolution Fabric with Cool Wear
- PROTECTION:** .50mm LE
- CORE:** Lightweight Lead or KIARMOR Lead-Free
- COLOR:** 500, 600, 700, 800, 900, and Remix series (Pages 22-24)
- BASE FABRIC:** Not Available in this model



Shown: Left surgery drop-away shoulder closure



Shown: Elastic back helps secure a proper fit

All non-overlapping sections are .25mm LE *

REVOLUTION

Base Aprons

Revolution Base offers all the comfort and protection of our premium Revolution line, but with our classic nylon colors and patterns. Revolution Base does not include Revolution Fabric, Color-Blocking or Cool-Wear.

- SIZE:** xSmall - 2xLarge (Pages 8-9)
- FABRIC:** Nylon
- PROTECTION:** .25mm LE, .35mm LE, and .50mm LE (Options Vary per Model)
- CORE:** Lightweight Lead or KIARMOR Lead-Free
- COLOR:** Classic color & patterns options Only



BL103

Vest & Skirt - Lumbar Belt



B103

Vest & Skirt



B203

Full Wrap Apron - Lumbar Belt



B303

Front Panel Apron



B403

Front Panel Apron - Elastic back



B503

Front Panel Apron - Lumbar Belt



B603

Full Wrap Apron - Elastic back

500 SERIES

Front & Back Sections: Any Color Listed Below
Side Color Block: Black Only

600 SERIES

Front & Back Sections: Black Only
Side Color Block: Any Color Listed Below

FRONT & BACK COLOR CODES:

















			
501: Red	502: Fuchsia	504: Pink	505: Navy
			
506: Teal	507: Yellow	508: Sky Blue	509: Grey
			
510: Purple	511: White	512: Duck Green	513: Tide Red
			
514: Jewelry Box Blue	515: Orange	517: Light Blue/Serenity	518: Royal Blue
			
519: Coral			

SIDE COLOR BLOCK:

Black Only

Model: 103 Color Shown: 518

SIDE COLOR BLOCK CODES:

			
601: Red	602: Fuchsia	604: Pink	605: Navy
			
606: Teal	607: Yellow	608: Sky Blue	609: Grey
			
610: Purple	611: White	612: Duck Green	613: Tide Red
			
614: Jewelry Box Blue	615: Orange	617: Light Blue/Serenity	618: Royal Blue
			
619: Coral			

FRONT & BACK COLOR:

Black Only

Model: 103 Color Shown: 618





700 SERIES

Full Apron: Any Color Listed Below
(This series has no "Side Color Block")

800 SERIES

Front & Back Sections: Any Color Listed Below
Side Color Block: White Only

FULL APRON COLOR CODES:

















			
700: Black	701: Red	702: Fuchsia	704: Pink
			
705: Navy	706: Teal	707: Yellow	708: Sky Blue
			
709: Grey	710: Purple	711: White	712: Duck Green
			
713: Tide Red	714: Jewelry Box Blue	715: Orange	717: Light Blue/ Serenity
			
718: Royal Blue	719: Coral		

SIDE COLOR BLOCK:

Not Available in this Series

Model: 103 Color Shown: 718

FRONT & BACK COLOR CODES:

			
801: Red	802: Fuchsia	804: Pink	805: Navy
			
806: Teal	807: Yellow	808: Sky Blue	809: Grey
			
810: Purple	812: Duck Green	813: Tide Red	814: Jewelry Box Blue
			
815: Orange	817: Light Blue/ Serenity	818: Royal Blue	819: Coral

SIDE COLOR BLOCK:

White Only

Model: 103 Color Shown: 818

900 SERIES

Front & Back Sections: White Only
Side Color Block: Any Color Listed Below

SIDE COLOR BLOCK CODES:

			
901: Red	902: Fuchsia	904: Pink	905: Navy
			
906: Teal	907: Yellow	908: Sky Blue	909: Grey
			
910: Purple	912: Duck Green	913: Tide Red	914: Jewelry Box Blue
			
915: Orange	917: Light Blue/ Serenity	918: Royal Blue	919: Coral

FRONT & BACK COLOR:

White Only

Model: 103 Color Shown: 918

REMIX SERIES

Mix & Match Any Two Colors
(Upcharge Applies)

REMIX COLOR SERIES

Choose one
main color.



Choose one
Side color block.



ADD ANY **STANDARD**
INTERIOR COLOR OR
PATTERN ON THE **INSIDE**
OF YOUR APRON





IF YOU HAVE ANY QUESTIONS ABOUT CHOOSING THE
RIGHT RADIATION PROTECTION GARMENT FOR YOU,
PLEASE CONTACT US TO SCHEDULE A

FREE CONSULTATION

Phone: 805-987-5255 | Email: info@infabcorp.com

CLASSIC

Key Features



Smart Track



Abrasion Resistant



Flame Resistant



Water Resistant



Bacteria Resistant



Custom Patterns



Monograms can be added either in "Block" or "Script" to any INFAB Aprons

How to Measure for Your New Apron

- Take all measurements with a cloth measuring tape.
- Measurements should be taken over your clothing.
- Do not attempt to take your own measurements. You should request the help of an assistant for best accuracy.
- Refer to the Find Your Size diagram for proper location of measurements.
- Some apron patterns are cut for specific genders. In these instances, if users of various genders will be sharing aprons, plan to consider male size options. If aprons are being purchased for separate gender use, plan to select the specific gender of the wearer(s) to ensure the best protection/fit.
- Once all measurements have been taken, refer to our sizing chart to find your size.
- If it is determined that a user is between sizes, consider the larger size. Garments that are too big may be made smaller; however, garments that are too small cannot be made larger.

The Tools You Will Need

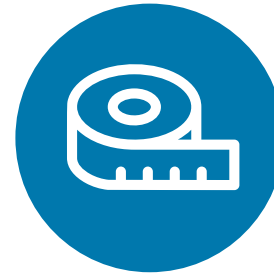

Cloth Measuring Tape



Pencil & Paper



Measuring Assistant

Find Your Size



If you see this icon, it means that the apron has its own unique measurements.

HELPFUL HINTS

Chest (C): Measure widest part 1" below armhole.

Waist (W): Measure narrowest part 1" above navel.

Hips (H): Measure widest part of hips.

Length (L): We recommend 1" above the knee.

Classic Front Panel Apron Length (*)

Location	xSmall, Small, Medium, Large, xLarge, 2xLarge
Front	38" / 97 cm

Classic Full Wrap Apron Length (*)

Location	xSmall, Small, Medium, Large, xLarge, 2xLarge
Wraparound	38" / 97 cm

Reverse & Elastic Vest Sizing (*)

Location	xSmall	Small	Medium	Large	xLarge	2xLarge
Length (L)	24" / 61 cm	24" / 61 cm	26" / 66 cm	27" / 69 cm	28" / 71 cm	29" / 74 cm

Classic Vest Sizing (*)

Location	xSmall	Small	Medium	Large	xLarge	2xLarge
Length (L)	20" / 51 cm	22" / 56 cm	24" / 61 cm	25" / 64 cm	26" / 66 cm	27" / 69 cm

Classic Skirt Sizing (*)

Location	xSmall	Small	Medium	Large	xLarge	2xLarge
Length (L)	18" / 47 cm	20" / 51 cm	22" / 56 cm	23" / 58 cm	24" / 61 cm	25" / 64 cm

Measure from high point shoulder to about 1" above the knee. This will be your one piece apron length.

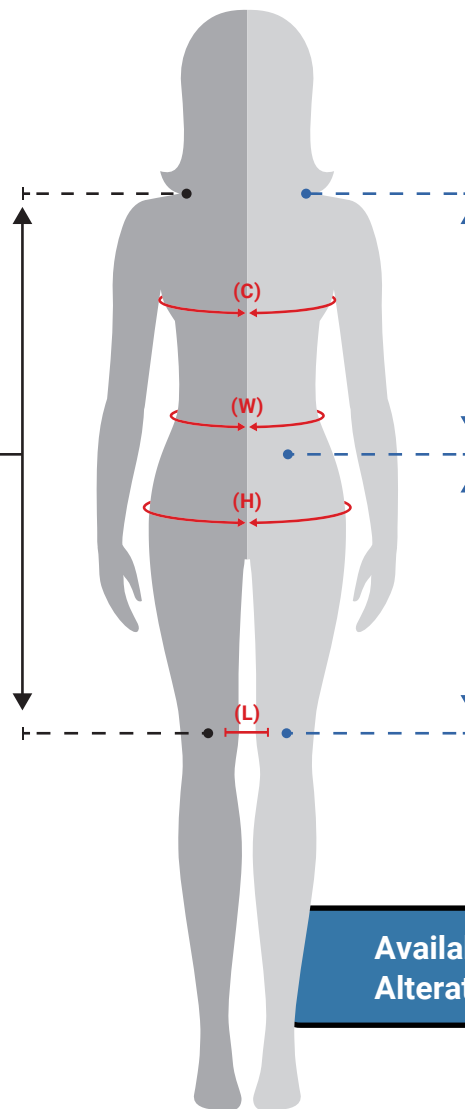

Measure from high point shoulder to desired skirt belt line. Then add 4" to find your vest length.

Measure from your desired skirt belt line to about 1" above the knee. This will be your skirt length.

Available Length Alteration of (±2" or ±4")

Female Measurements (Applies to All *)

Location	xSmall	Small	Medium	Large	xLarge	2xLarge
Chest (C)	30-32" / 76-81 cm	33-36" / 84-91 cm	37-39" / 94-99 cm	40-42" / 102-107 cm	43-45" / 109-114 cm	46-48" / 117-122 cm
Waist (W)	25-27" / 64-67 cm	28-30" / 71-76 cm	31-33" / 78-84 cm	34-36" / 86-91 cm	37-39" / 94-99 cm	40-42" / 102-107 cm

Contact us for sizes above 2XL

Find Your Size

SPECIAL SIZING

If you see this icon, it means that the apron has its own unique measurements.

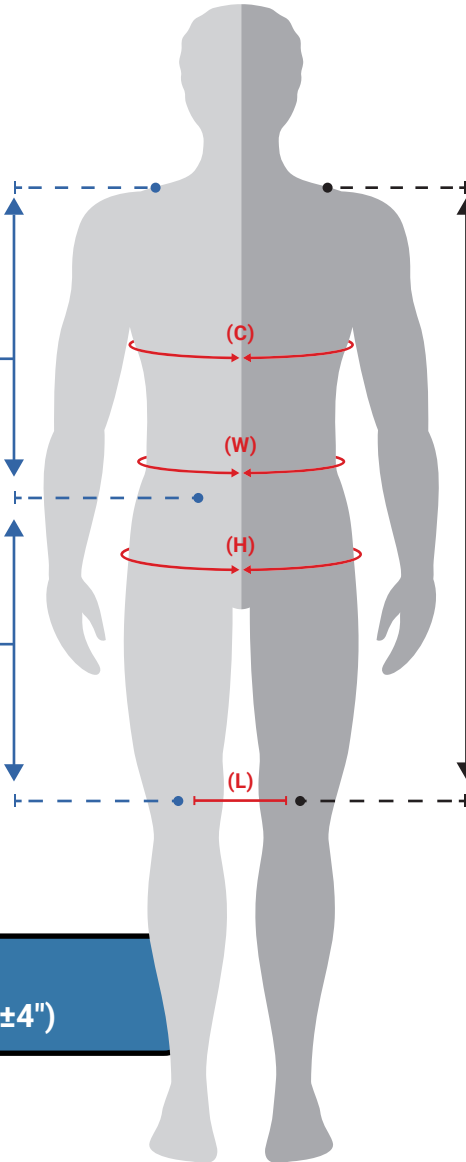

Measure from high point shoulder to desired skirt belt line. Then add 4" to find your vest length.

Measure from your desired skirt belt line to about 1" above the knee. This will be your skirt length.

Measure from high point shoulder to about 1" above the knee. This will be your one piece apron length.

Available Length Alteration of (±2" or ±4")

Male Measurements (Applies to All *)

Location	Small	Medium	Large	xLarge	2xLarge
Chest (C)	34-37" / 86-94 cm	38-41" / 97-104 cm	42-45" / 107-114 cm	46-49" / 117-125 cm	50-52" / 127-132 cm
Waist (W)	28-31" / 71-79 cm	32-35" / 81-89 cm	36-39" / 91-99 cm	40-43" / 102-109 cm	44-46" / 112-117 cm

Contact us for sizes above 2XL

HELPFUL HINTS

- Chest (C):** Measure widest part 1" below armhole.
- Waist (W):** Measure narrowest part 1" above navel.
- Hips (H):** Measure widest part of hips.
- Length (L):** We recommend 1" above the knee.

Classic Front Panel Apron Length (*)

Location	Small, Medium, Large	xLarge	2xLarge
Front	38" / 97 cm	42" / 107 cm	44" / 112 cm

Classic Full Wrap Apron Length (*)

Location	Small, Medium, Large, xLarge, 2xLarge
Wraparound	38" / 97 cm

Reverse & Elastic Vest Sizing (*)

Location	Small	Medium	Large	xLarge	2xLarge
Length (L)	25" / 64 cm	27" / 69 cm	28" / 71 cm	30" / 76 cm	30" / 76 cm

Classic Vest Sizing (*)

Location	Small	Medium	Large	xLarge	2xLarge
Length (L)	22" / 56 cm	24" / 61 cm	25" / 64 cm	26" / 66 cm	28" / 71 cm

Classic Skirt Sizing (*)

Location	Small	Medium	Large	xLarge	2xLarge
Length (L)	20" / 51 cm	22" / 56 cm	23" / 58 cm	24" / 61 cm	25" / 64 cm

Core Material Configurations



Overlapping Sections



Non-Overlapping Sections

Overlapping LE #

Non-Overlapping LE #

FULL OVERLAP

CLASSIC Full Wrap Vest and Skirt Aprons *REQUIRE* a full overlap to achieve the stated protection level shown.

CLASSIC: VAS

CLASSIC: LSW, MWA, FCW

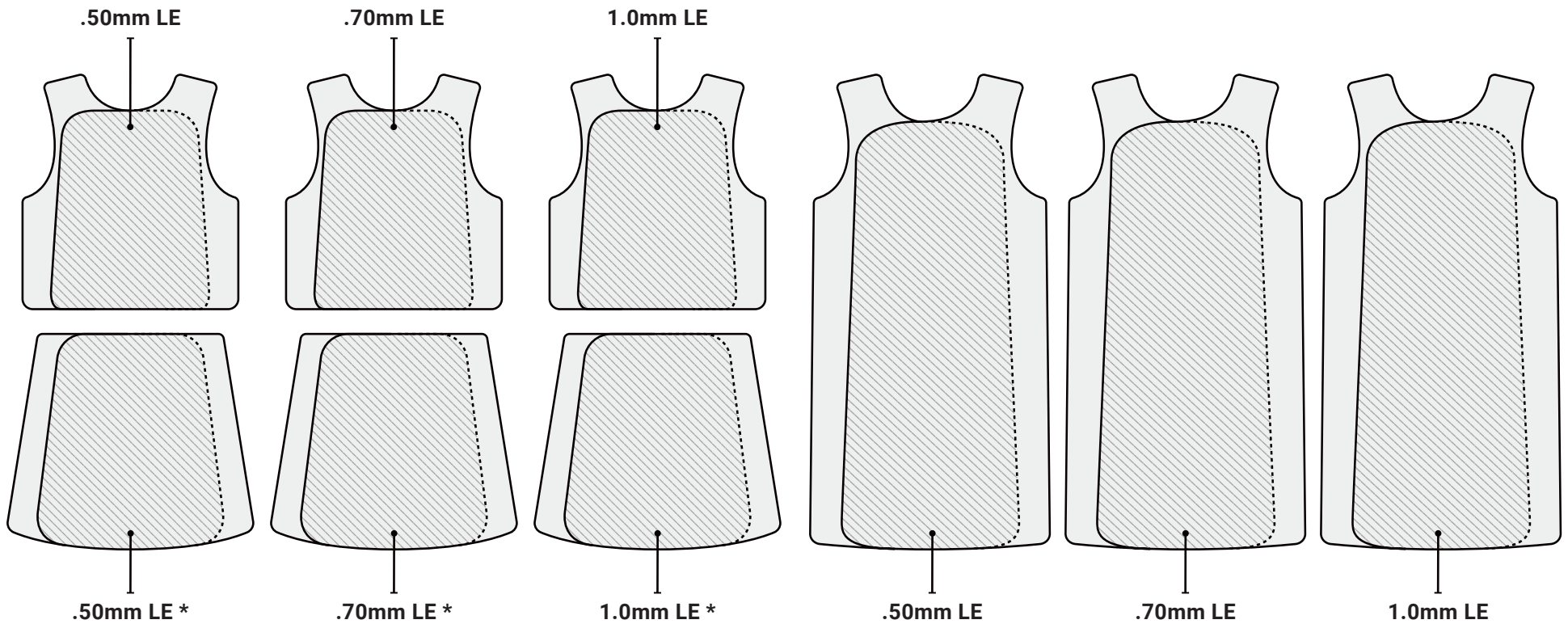

(REMINDER: These Apron's LE is achieved by Full Overlap)

(REMINDER: These Apron's LE is achieved by Full Overlap)

Core Material Configurations



Overlapping Sections



Non-Overlapping Sections



Overlapping LE #



Non-Overlapping LE #

NO OVERLAP

CLASSIC Front Wrap Apron's and Vest's achieve the stated protection level shown.
Only the CLASSIC Skirt **REQUIRE** a full overlap to achieve the stated protection level shown.

CLASSIC: AWC, EBA, LSF, WBT, SPL, SDO, SDA, TFAM, DTL-TECH, DTL-PANO, DTL-ADULT, DTL-ADULT-TC, DTL-CHILD, DTL-CHILD-TC • EVAS, RVAS

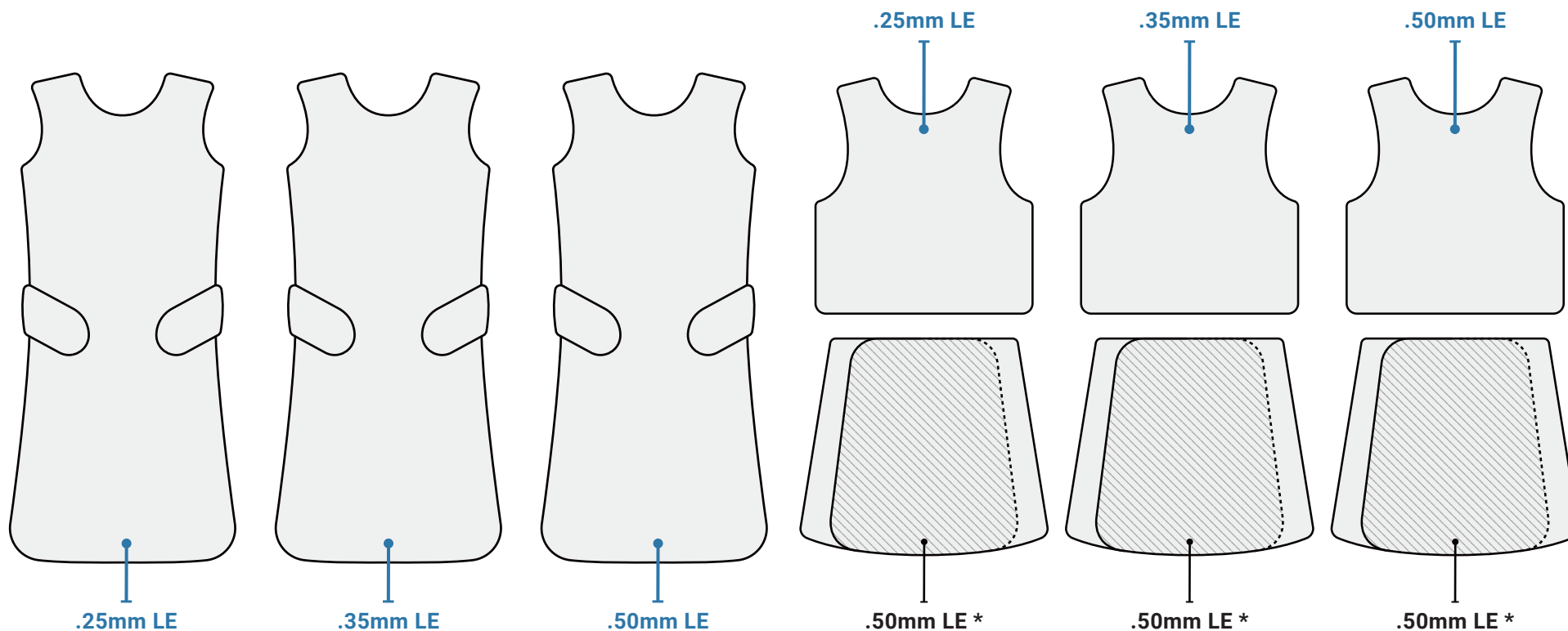

(Most backing of these apron's will match the front LE shown)

All non-overlapping skirt sections are .25mm LE *

VAS

Classic Vest and Skirt

The Classic Vest and Skirt apron provides full overlap protection and maximum weight distribution between the shoulders and hips, eliminating stress on the upper and lower back. SmartTrack enabled.

- SIZE:** xSmall - 2xLarge (Pages 28-29)
- FABRIC:** Nylon (with a double welt pocket)
- PROTECTION:** .50mm LE, .70mm LE, and 1.0mm LE
- CORE:** Lightweight Lead or KIARMOR Lead-Free
- PRINT:** Solid and pattern options (Pages 41-47)



RVAS

Reverse Vest & Skirt

The Reverse Vest and Skirt apron provides maximum weight distribution. Criss-cross elastic back straps provide weight relief and lumbar support, while the adjustable shoulder strap ensures a precise fit. SmartTrack enabled.

- SIZE:** xSmall - 2xLarge (Pages 28-29)
- FABRIC:** Nylon (with a double welt pocket)
- PROTECTION:** .25mm LE, .35mm LE, and .50mm LE
- CORE:** Lightweight Lead or KIARMOR Lead-Free
- PRINT:** Solid and pattern options (Pages 41-47)



SPECIAL SIZING

- ST
- Paintbrush icon
- Shield with arrows icon
- Water drop icon
- Flame with slash icon
- Gear with slash icon

EVAS Elastic Vest & Skirt

The Elastic Vest and Skirt apron provides maximum weight distribution. Criss-cross elastic back straps provide weight relief and lumbar support, while the adjustable back strap ensures a precise fit. SmartTrack enabled.

- SIZE:** xSmall - 2xLarge (Pages 28-29)
- FABRIC:** Nylon (with a double welt pocket)
- PROTECTION:** .25mm LE, .35mm LE, and .50mm LE
- CORE:** Lightweight Lead or KIARMOR Lead-Free
- PRINT:** Solid and pattern options (Pages 41-47)

SPECIAL SIZING



Model: EVAS Print Shown: SH-1

LSW Full Overlap Apron with Lumbar Belt

The Black Belt Full Wrap apron offers maximum protection with full overlap, featuring a snap-on, fully adjustable lumbar Black Belt®. This apron combines comfort with superior lumbar support, which reduces fatigue and upper back stress during lengthy procedures. Built-in slits on each side with hook and loop closures provide increased mobility. SmartTrack enabled.

- SIZE:** xSmall - 2xLarge (Pages 28-29)
- FABRIC:** Nylon (with a double welt pocket)
- PROTECTION:** .50mm LE, .70mm LE, and 1.0mm LE
- CORE:** Lightweight Lead or KIARMOR Lead-Free
- PRINT:** Solid and pattern options (Pages 41-47)



Hook and Loop Closure Side Slits



Model: LSW Print Shown: SH-6

MWA Special Wrap Apron

The Special Wrap apron is uniquely designed to offer full protection with an adjustable shoulder strap and front belt buckle closure. SmartTrack enabled.

- SIZE:** xSmall - 2xLarge (Pages 28-29)
- FABRIC:** Nylon (with a double welt pocket)
- PROTECTION:** .25mm LE, .35mm LE, and .50mm LE
- CORE:** Lightweight Lead or KIARMOR Lead-Free
- PRINT:** Solid and pattern options (Pages 41-47)



Model: MWA Print Shown: SH-7

FCW Full Coat Wrap

The Full Coat Wrap offers maximum front and back full overlap protection. Built-in slits on each side with hook and loop closures provide increased mobility. SmartTrack enabled.

- SIZE:** xSmall - 2xLarge (Pages 28-29)
- FABRIC:** Nylon (with a double welt pocket)
- PROTECTION:** .50mm LE, .70mm LE, and 1.0mm LE
- CORE:** Lightweight Lead or KIARMOR Lead-Free
- PRINT:** Solid and pattern options (Pages 41-47)



Hook and Loop Closure Side Slits



AWC

Weight Reliever

The Weight Reliever front protection apron features side closure straps at the waist which relieve weight from the shoulders and adjust for the most comfortable fit. SmartTrack enabled.

- SIZE:** xSmall - 2xLarge (Pages 28-29)
- FABRIC:** Nylon (with a double welt pocket)
- PROTECTION:** .25mm LE, .35mm LE, and .50mm LE
- CORE:** Lightweight Lead or KIARMOR Lead-Free
- PRINT:** Solid and pattern options (Pages 41-47)



Model: AWC Print Shown: SH-2

EBA

Elastic Back

The Elastic Back front protection apron features elastic side closure straps providing weight relief, comfort, and flexibility. SmartTrack enabled.

- SIZE:** xSmall - 2xLarge (Pages 28-29)
- FABRIC:** Nylon (with a double welt pocket)
- PROTECTION:** .25mm LE, .35mm LE, and .50mm LE
- CORE:** Lightweight Lead or KIARMOR Lead-Free
- PRINT:** Solid and pattern options (Pages 41-47)



Model: EBA Print Shown: MIR280-09



LSF Black Belt Front Protection

The Black Belt Front Protection apron provides frontside body protection while offering snap-on, fully adjustable Black Belt® lumbar support. The built-in back strap provides better weight distribution between the shoulders and waist. SmartTrack enabled.

- SIZE:** xSmall - 2xLarge (Pages 28-29)
- FABRIC:** Nylon (with a double welt pocket)
- PROTECTION:** .25mm LE, .35mm LE, and .50mm LE
- CORE:** Lightweight Lead or KIARMOR Lead-Free
- PRINT:** Solid and pattern options (Pages 41-47)



Model: LSF Print Shown: 201

WBT Wide Belt Apron

The Wide Belt apron offers frontside protection with a belt and buckle closure, adjustable for a comfortable fit. SmartTrack enabled.

- SIZE:** xSmall - 2xLarge (Pages 28-29)
- FABRIC:** Nylon (with a double welt pocket)
- PROTECTION:** .25mm LE, .35mm LE, and .50mm LE
- CORE:** Lightweight Lead or KIARMOR Lead-Free
- PRINT:** Solid and pattern options (Pages 41-47)



Model: WBT Print Shown: SH-12



SPL Budget Saver

The Budget Saver front protection apron features criss-cross tie straps for a secure, snug fit and comfortable shoulder pads. SmartTrack enabled.

- SIZE:** xSmall - 2xLarge (Pages 28-29)
- FABRIC:** Nylon
- PROTECTION:** .25mm LE, .35mm LE, and .50mm LE
- CORE:** Lightweight Lead or KIARMOR Lead-Free
- PRINT:** Solid and pattern options (Pages 41-47)

SDO Surgery Drop Off

The Surgery Drop Off front protection apron is designed to be removed without breaking the sterile field. Additional handle straps located on top of shoulders for easy removal or drop off. Attaches in the front with hook and loop closures. SmartTrack enabled.

- SIZE:** xSmall - 2xLarge (Pages 28-29)
- FABRIC:** Nylon (with a double welt pocket)
- PROTECTION:** .25mm LE, .35mm LE, and .50mm LE
- CORE:** Lightweight Lead or KIARMOR Lead-Free
- PRINT:** Solid and pattern options (Pages 41-47)



Model: SPL Print Shown: SH-9



Model: SDO Print Shown: SH-3



SDA Surgery Drop Away

The Surgery Drop Away front protection apron features hook and loop closures at the top of each shoulder for easy removal without breaking the sterile field. The back strap provides a secure fit. SmartTrack enabled.

- SIZE:** xSmall - 2xLarge (Pages 28-29)
- FABRIC:** Nylon (with a double welt pocket)
- PROTECTION:** .25mm LE, .35mm LE, and .50mm LE
- CORE:** Lightweight Lead or KIARMOR Lead-Free
- PRINT:** Solid and pattern options (Pages 41-47)

TFAM Tri-Flap

The Tri-Flap apron features a split front panel to provide protection and comfort while seated. Criss-cross straps attach in front with a hook and loop closure. SmartTrack enabled.

- SIZE:** xSmall - 2xLarge (Pages 28-29)
- FABRIC:** Nylon (with a double welt pocket)
- PROTECTION:** .25mm LE, .35mm LE, and .50mm LE
- CORE:** Lightweight Lead or KIARMOR Lead-Free
- PRINT:** Solid and pattern options (Pages 41-47)



Model: SDA Print Shown: SH-10



Model: TFAM Print Shown: 268

DTL-TECH

Dental Technician Apron

The Dental Technician Apron front protection apron features criss-cross tie straps for a secure, snug fit and comfortable shoulder pads. SmartTrack enabled.

SIZE:	24" W x 36" L
FABRIC:	Nylon
PROTECTION:	.35mm LE
CORE:	Lightweight Lead or KIARMOR Lead-Free
PRINT:	Solid and pattern options (Pages 41-47)

**DTL-PANO**

Pano Cape Dental Apron

The Pano Cap Dental Apron drapes over your patient's shoulders. The inner liner of this cape uses a non-slip material and fastens in the back with a hook and loop closure. SmartTrack enabled.

SIZE:	23" W x 25" L
FABRIC:	Nylon
PROTECTION:	.35mm LE
CORE:	Lightweight Lead or KIARMOR Lead-Free
PRINT:	Solid and pattern options (Pages 41-47)



DTL-ADULT

Adult Dental Apron

The Adult Dental Apron provides front protection for the patient, using a non-slip material to keep it firmly in position. An attached thyroid collar option is available in this style. SmartTrack enabled.

- SIZE:** 24" W x 27" L
- FABRIC:** Nylon
- PROTECTION:** .35mm LE
- CORE:** Lightweight Lead or KIARMOR Lead-Free
- PRINT:** Solid and pattern options (Pages 41-47)



DTL-ADULT-TC
Dental Apron with attached thyroid collar

DTL-CHILD

Child Dental Apron

The Child Dental Apron provides front protection for the patient, using a non-slip material to keep it firmly in position. An attached thyroid collar option is available in this style. SmartTrack enabled.

- SIZE:** 18" W x 23" L
- FABRIC:** Nylon
- PROTECTION:** .35mm LE
- CORE:** Lightweight Lead or KIARMOR Lead-Free
- PRINT:** Solid and pattern options (Pages 41-47)



DTL-CHILD-TC
Dental Apron with attached thyroid collar

CLASSIC Colors —————

No Up-Charge

We use high quality nylon and polyester fabrics for all of our products. A polyurethane coating on the inside seals the cloth from fluid penetration and makes it easier to clean. Color-fast dyes won't transfer to your clothing. Colors and patterns may be added and discontinued at any time. For the most up to date list of apron colors, visit www.infabcorp.com/colors

				
103: Taupe	104: Navy Blue	105: Red	106: Chocolate	107: Kelly Green
				
108: Royal Blue	111: Burgundy	112: Grey	114: Black	117: Teal
				
118: Fuschia	119: Purple	129: Hunter Green	154: Orange	202: Sky Blue
				
204: Gold	205: Charcoal			



Mix Colors/Patterns with Colored Trim
Create Your Own Unique Look. Example on Page: 45

Custom Made —————

Up-Charge

INFAB offers the ability to make custom fabrics for any of our Classic style radiation protection aprons. Our team will work with you to create a unique, one-of-a-kind designed apron of your own.

EXAMPLE: LT221-10 Hot Hoops

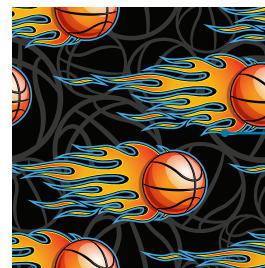

Model: B103 Pattern Shown: LT221-10 Hot Hoops

CLASSIC Patterns

No Up-Charge



120: Camouflage

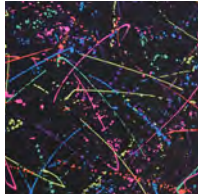

140: Splash



157: Teal Plaid

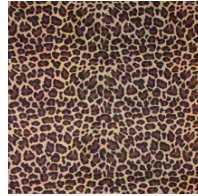

167: Cheetah



168: New Jeans

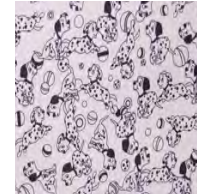

172: Puppies

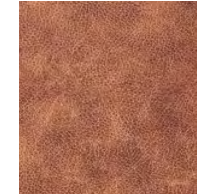

174: Leather



176: Rainbow Wave



177: Butterflies



180: Orange Hawaii

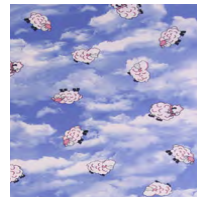

182: Sheep in Clouds



184: Pink Camouflage



185: White Dots on Pink

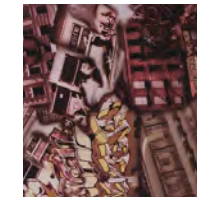

188: American Graffiti



201: Digital Camo

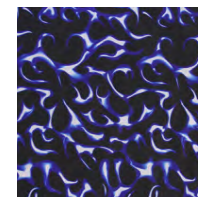

207: Blue Flame

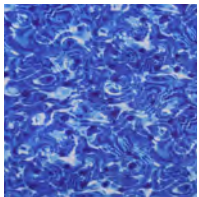

208: Blue Wash

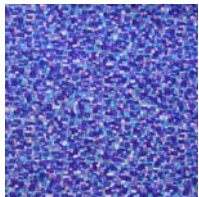

209: Chicklets



210: Skulls

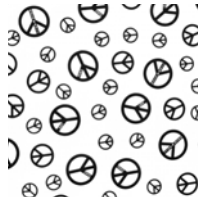

211: Peace

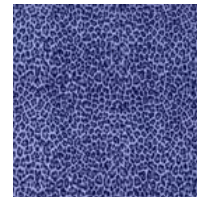

212: Animal Print Blue

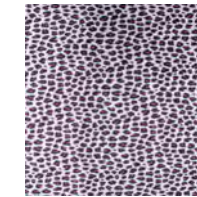

214: Animal Print Pink



216: Dragons



217: Mardi Gras



218: Mamba



219: Pink Paws

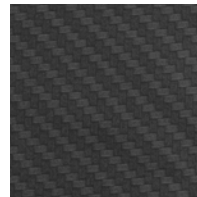

251: Carbon Fiber

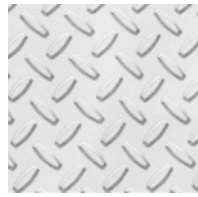

252: Steel



261: Red Skulls

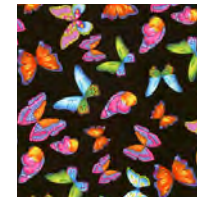

262: Black Butterflies



263: Chocolate Giraffe

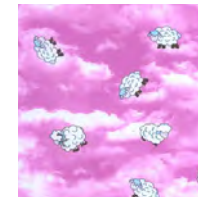

264: Sheep in Clouds Pink

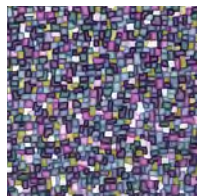

265: Chicklets Purple

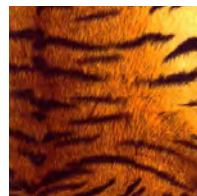

266: Tiger Skin

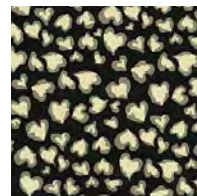

267: Abstract Hearts

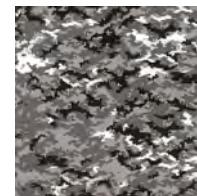

268: Digital Camo Black

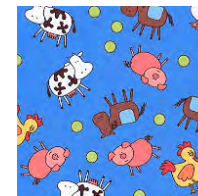

269: Animal Farm

CLASSIC Patterns

No Up-Charge



SH-1: Graffiti Hearts

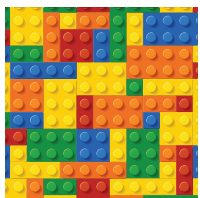

SH-2: Blocks

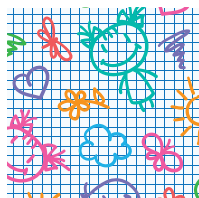

SH-3: Kid Sketch

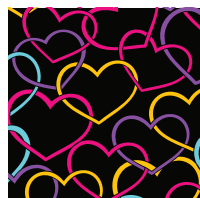

SH-4: Stylized Hearts

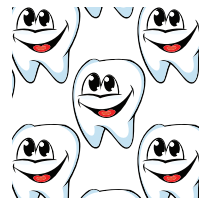

SH-5: Teeth



SH-6: Color Camo

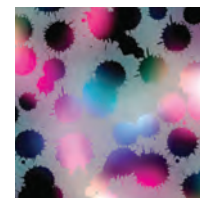

SH-7: Metallic Splatter

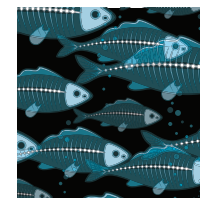

SH-8: Fish Bones



SH-9: Sports



SH-10: Cats



SH-11: Red Plaid

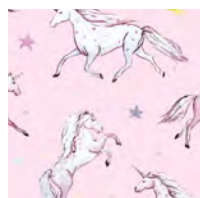

SH-12: Unicorn

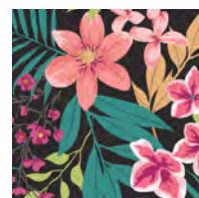

SH-13: Hawaiian Flowers

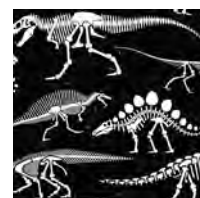

SH-14: Dino Fossil

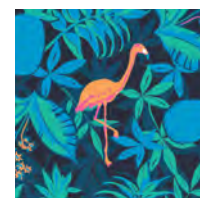

SH-15: Flamingo



SH-16: Purple Plaid



SH-17: Race Car



SH-18: Shape Camo

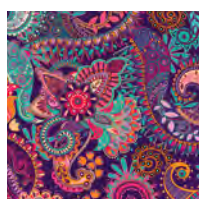

SH-19: Pink Paisley



SH-20: New Flames

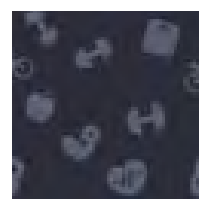

SH-22: Fitness

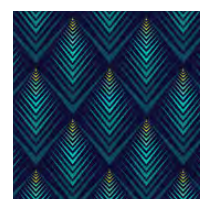

SH-23: Art Deco



SH-24: Cactus

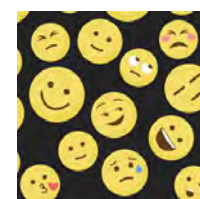

SH-25: Emoji

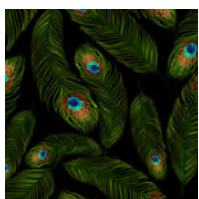

SH-26: Peacock



SH-27: Orange Blocks



SH-28: 80's Palm

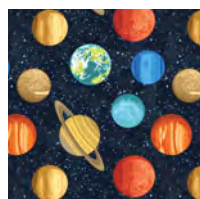

SH-29: Planets

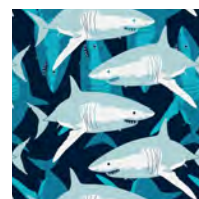

SH-30: Sharks

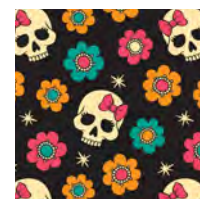

SH-31: Sugar Skulls

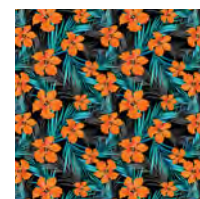

SH-32: Orange Hibiscus



SH-33: Christmas Sweater

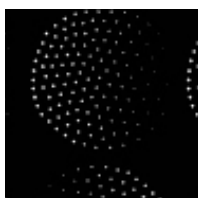

SH-35: Moon Cycle



SH-36: Colored Fossils

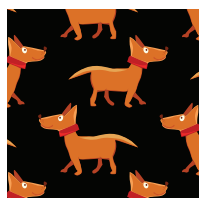

SH-37: Dachshund



SH-38: Astronaut



SH-39: Space Fun



SH-40: Frenchies

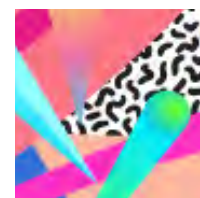

SH-42: 80's

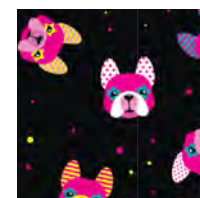

SH-44: 80's Abstract Frenchies

CLASSIC Patterns

No Up-Charge

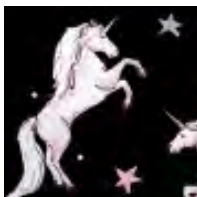

SH-48: Black Unicorn

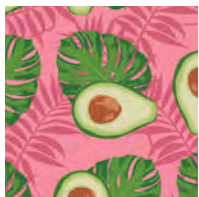

SH-49: Tropical Avocado

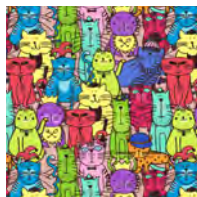

SH-50: Colorful Cats

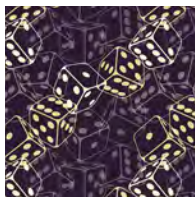

SH-51: Dice



SH-52: Mixed Dogs



SH-53: Happy Hippo

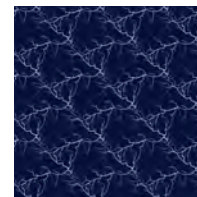

SH-54: Lightning

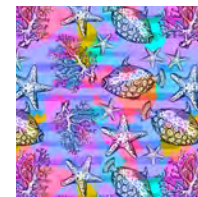

SH-55: Ocean Life



SH-56: Rubber Ducks

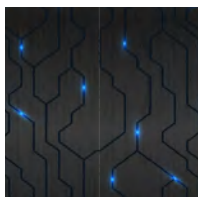

SH-57: Electric Steel

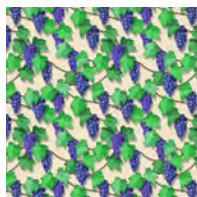

SH-58: Wine Grapes

Colors and patterns may be added or discontinued at any time. For the most up-to-date list of apron colors, visit www.infabcorp.com/colors.

**YOUR PROTECTION IS
OUR #1 PRIORITY**

CLASSIC Colors

No Up-Charge

INFAB offers a variety of colors for your apron. Color-fast dyes won't ever transfer to your clothing. Colors and patterns may be added and discontinued at any time. For the most up to date list of apron colors, visit www.infabcorp.com/colors

Trim Color Options



103:
Taupe



104:
Navy Blue



105:
Red



106:
Chocolate



107:
Kelly Green



108:
Royal Blue



111:
Burgundy



112:
Grey

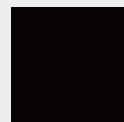

114:
Black



117:
Teal



118:
Fuchsia



119:
Purple



129:
Hunter Green



154:
Orange



204:
Gold



205:
Charcoal

Example

Mix Colors/Patterns and Trims
Create Your Own Unique Look at No Extra Charge



118: Apron Color



204: Trim Color



Model: AWC Color Shown: 118 Fuschia Trim Shown: 204 Gold

CLASSIC Ripstop

No Up-Charge

Ripstop fabrics are woven fabrics, often made of nylon, using a special reinforcing technique that makes them resistant to tearing and ripping. A polyurethane coating on the inside seals the cloth from fluid penetration and makes it easier to clean. Color-fast dyes won't transfer to your clothing. Colors and patterns may be added and discontinued at any time. For the most up to date list of apron colors, visit www.infabcorp.com/colors



190:
Blue
Diamond Ripstop

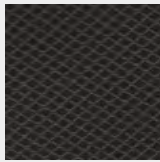

192:
Grey
Diamond Ripstop

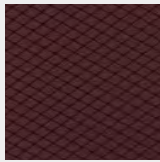

194:
Burgundy
Diamond Ripstop

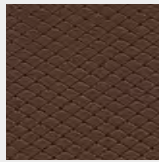

196:
Bronze
Diamond Ripstop



197:
Red
Diamond Ripstop

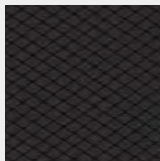

198:
Black
Diamond Ripstop

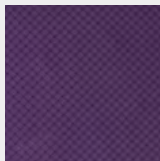

199:
Purple
Diamond Ripstop



200:
Hunter Green
Diamond Ripstop

Close up view of the Ripstop pattern

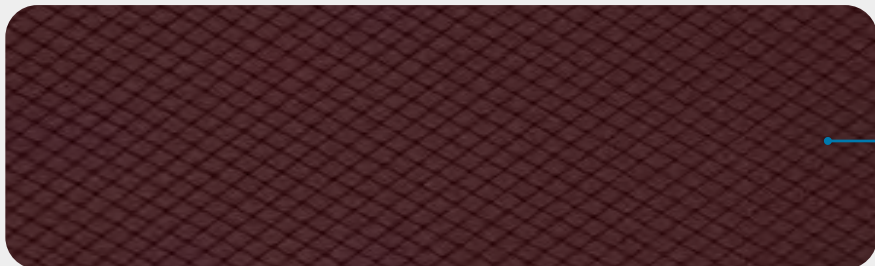

Colors and patterns may be added or discontinued at any time. For the most up-to-date list of apron colors, visit www.infabcorp.com/colors.

Example



Model: B103 Print Shown: 194 Burgundy Diamond Ripstop

CLASSIC Premium Patterns

Up-Charge



SCP258-54
Vintage Postcard

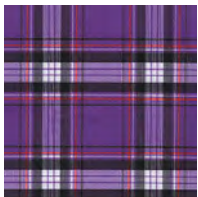

TFX755-45
Purple Plaid



SCP304-09
Dog Paw

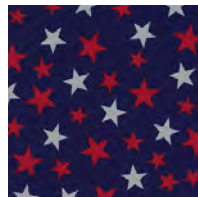

SCP337-57
American Stars



MIR222-55
Denim Pockets



SCP305-95
Dalmatians



TFX755-31
Pink Plaid



TFX778-57
Blue Mamba



TRP549-55
Hatchet Blue

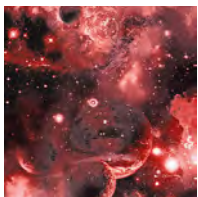

MIR280-05
Galaxy Red

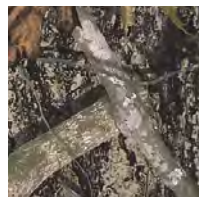

TRTB-NC65
Timber Camo

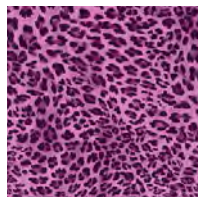

TFX767-37
Baby Leo



CAS009-33
Wildcat Pink

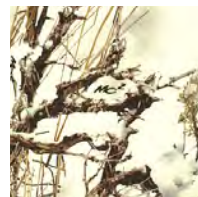

TRTB-MC2
Snow Camo



MIR215-51
Blue Camo

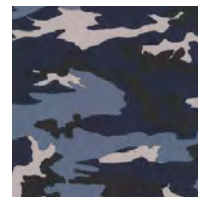

MIR215-55
Navy Camo

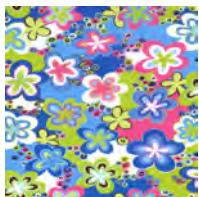

MIR239-53
Happy Talk



SCP084-60
Dancing Zebras

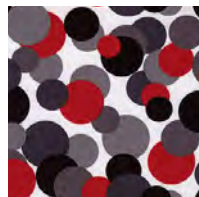

MIR260-03
Candy Circles

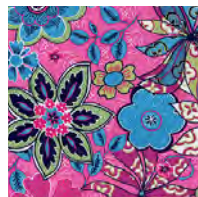

MIR272-33
Mantis Pink

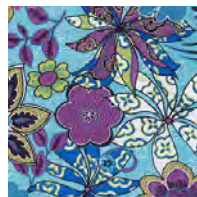

MIR272-53
Mantis Blue

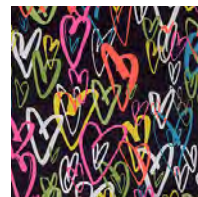

MIR278-09
Crayon Hearts



MIR280-09
Galaxy

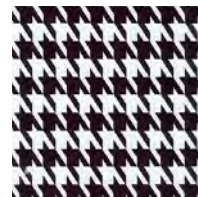

SCP393-09
Hounds Tooth

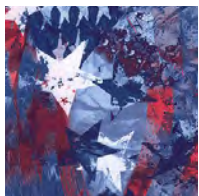

MIR285-57
Star Gazer



TXF779-44
Mystery Splash

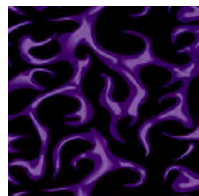

SCP088-43
Purple Flame

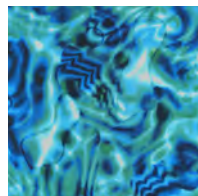

SCP244-85
Teal Splash

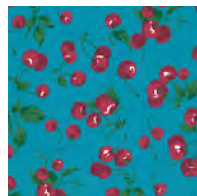

SCP098-82
Red Cherries

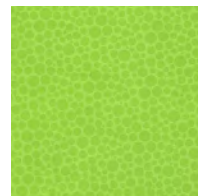

SCP139-13
Green Lantern

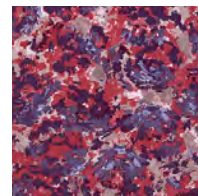

SCP145-95
Red Granite



Quick Ship Aprons



Ready to Ship



Smart Track



Abrasion Resistant



Flame Resistant



Water Resistant

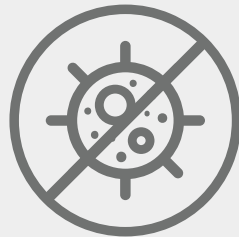

Bacteria Resistant

Available in Six Colors



114:
Black



108:
Royal Blue

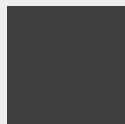

205:
Charcoal



119:
Purple



105:
Red



117:
Teal

UVS

Lightning Vest & Skirt

The Lightning Vest and Skirt apron provides full overlap protection and maximum weight distribution between the shoulders and hips, eliminating stress on the upper and lower back. SmartTrack enabled. Available in-stock and ready to ship.

- SIZE:** Small - 2xLarge
- FABRIC:** Nylon (with a double welt pocket)
- PROTECTION:** .35mm LE, and .50mm LE
- CORE:** KIARMOR Lead-Free, Lightweight Lead,
- COLORS:** Black, Blue, Charcoal, Purple, Red, Teal



Size	Chest	Waist	Vest Front	Skirt
S	34-37" / 86-94 cm	28-31" / 71-79 cm	24" / 61 cm	20" / 51 cm
M	38-41" / 97-104 cm	32-35" / 81-89 cm	24" / 61 cm	22" / 56 cm
L	42-45" / 107-114 cm	36-39" / 91-99 cm	24" / 61 cm	23" / 58 cm
XL	46-49" / 117-125 cm	40-43" / 102-109 cm	24" / 61 cm	24" / 61 cm
2XL	50-52" / 127-132 cm	44-46" / 112-117 cm	24" / 61 cm	25" / 64 cm

Model: UVS Color Shown: Purple

UFW

Lightning Full Wrap

The Lightning Full Wrap offers maximum front and back full overlap protection. Built-in slits on each side with hook and loop closures provide increased mobility. SmartTrack enabled. Available in-stock and ready to ship.

- SIZE:** Small - 2xLarge
- FABRIC:** Nylon (with a double welt pocket)
- PROTECTION:** .35mm LE, and .50mm LE
- CORE:** KIARMOR Lead-Free, Lightweight Lead,
- COLORS:** Black, Blue, Charcoal, Purple, Red, Teal



Size	Chest	Waist	Length
S	34-37" / 86-94 cm	28-31" / 71-79 cm	38" / 97 cm
M	38-41" / 97-104 cm	32-35" / 81-89 cm	38" / 97 cm
L	42-45" / 107-114 cm	36-39" / 91-99 cm	38" / 97 cm
XL	46-49" / 117-125 cm	40-43" / 102-109 cm	38" / 97 cm
2XL	50-52" / 127-132 cm	44-46" / 112-117 cm	38" / 97 cm

UFP

Lightning Front Protection

The Lightning Front Protection apron features side closure straps at the waist which relieve weight from the shoulders and adjust for the most comfortable fit. SmartTrack enabled. Available in-stock and ready to ship.

- SIZE:** Small - 2xLarge
- FABRIC:** Nylon (with a double welt pocket)
- PROTECTION:** .35mm LE, and .50mm LE
- CORE:** KIARMOR Lead-Free, Lightweight Lead,
- COLORS:** Black, Blue, Charcoal, Purple, Red, Teal



Size	Chest	Waist	Length
S	34-37" / 86-94 cm	28-31" / 71-79 cm	38" / 97 cm
M	38-41" / 97-104 cm	32-35" / 81-89 cm	38" / 97 cm
L	42-45" / 107-114 cm	36-39" / 91-99 cm	38" / 97 cm
XL	46-49" / 117-125 cm	40-43" / 102-109 cm	38" / 97 cm
2XL	50-52" / 127-132 cm	44-46" / 112-117 cm	38" / 97 cm



Model: UFW Color Shown: Teal

Model: UFP Color Shown: Charcoal



SMART TRACK

Track & Document Lead Apron Inspections

Manage all of your lead aprons in one place with Smart Track, the completely FREE and secure web-based garment tracking system.



HOW IT WORKS

1. Download the free app.
2. Create your Smart Track account.
3. Add your garments.
4. Document your inspections.
5. Set inspection reminders.
6. Export and download reports.

KEY FEATURES

- No Software & No Registration
- Garment Dashboard
- Custom Reports
- Bulk Uploads & Editing
- Filtered Search
- + More!

TRACK ANY GARMENT

Use your existing garment IDs or add Smart Track Retrofit Tags to any apron to get started. Smart Track Retrofit Tags feature unique IDs that can be scanned with the Smart Track App or any 2D scanner.

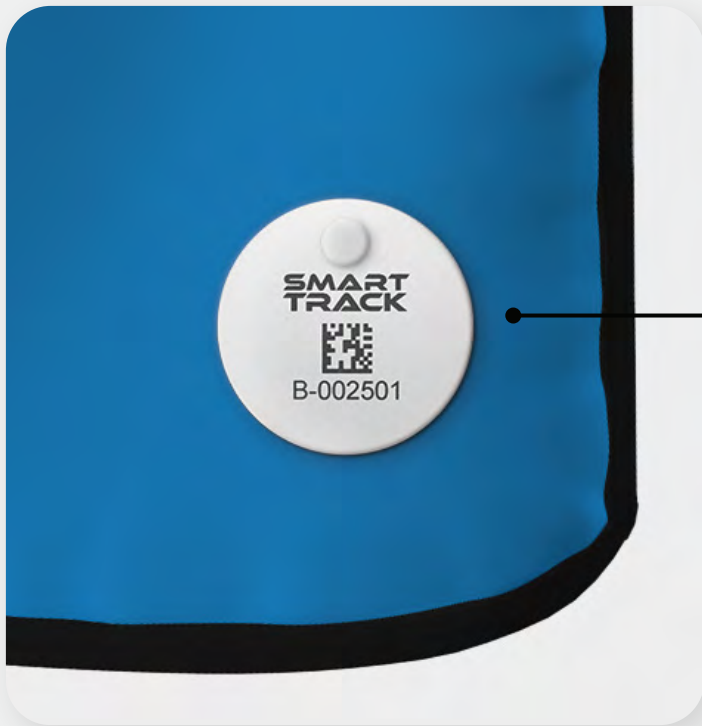

Annual Inspection Stickers



SMART TRACK Scanner

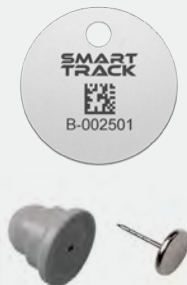

SMART TRACK 2D bar code tags with permanent security-style backing

TESTIMONIALS

"Smart Track makes it simple to manage my suite of lead aprons. We track over 100 aprons - it saves time and headaches."

Rich Norman – Lead Tech
Los Robles Hospital, Thousand Oaks, CA

"Tracking lead aprons and making sure that they have been inspected is a challenge for any large radiology facility. Of the many apron-tracking systems I reviewed, I knew that the "SMART TRACK" apron inventory system would work for our facility and meet new regulatory standards set by "The Joint Commission"...The system is user friendly. All I know is that anyone who has the burden of tracking aprons needs to get "Smart" about tracking their apron inventory".

Roseann Zeldin, RT, (R) (M), CNMT – Assistant Radiation Safety Officer Department of Radiology & Imaging
Hospital for Special Surgery New York City, New York

"The SMART TRACK Apron Inventory system has revolutionized the way lead apron quality control testing and inventory management is performed at our facility. It is a superior, comprehensive, and user-friendly product. Individual bar codes make tracking aprons quick and easy. It is the best system I have had the opportunity to work with."

Doug Beardsall MRT (R) CTIC – Senior Technologist QC
Royal Victoria Regional Health Center Barrie, Ontario



YouTube Video's AVAILABLE NOW!

Access our helpful videos on how to use the all new Smart Track App!

REV-TC REVOLUTION THYROID COLLAR

- SIZES:** One size fits most
- COLORS:** 500 Series, 600 Series, 700 Series, 800 Series, 900 Series, Remix
- CORE:** Lightweight Lead, KIARMOR Lead-Free
- CLOSURE:** Hook and Loop Closure, Buckle

- Large coverage area
- Exclusive Revolution outer fabric
- Cool Wear moisture-wicking liner
- Optional monogram
- Optional KTC attachment



NST THYROID COLLAR WITHOUT BINDING

- SIZES:** X-Small, Standard, Medium
- COLORS:** Revolution 700 Series & All Classic Nylon Colors
- CORE:** Lightweight Lead, KIARMOR Lead-Free
- CLOSURE:** Hook and Loop Closure, Buckle, Magnet

- Comfortable fit
- Large protection area
- Optional monogram
- Optional KTC attachment



SVT VISOR STYLE THYROID COLLAR

- SIZES:** X-Small, Standard, Medium
- COLORS:** All
- CORE:** Lightweight Lead, KIARMOR Lead-Free
- CLOSURE:** Hook and Loop Closure, Buckle

- Comfortable fit
- Large coverage area
- Optional monogram
- Optional KTC attachment



MTC MAGNETIC THYROID COLLAR

- SIZES:** X-Small, Standard, Medium
- COLORS:** All
- CORE:** Lightweight Lead, KIARMOR Lead-Free
- CLOSURE:** Magnet

- Comfortable fit
- Large coverage area
- Optional monogram
- Optional KTC attachment



TCV THYROID COLLAR WITH BINDING

- SIZES:** X-Small, Standard, Medium
COLORS: Revolution 700 series & All Classic Nylon Colors
CORE: Lightweight Lead, KIARMOR Lead-Free
CLOSURE: Hook and Loop Closure, Buckle or Magnet

- Comfortable fit
- Large protection area
- Optional monogram
- Optional KTC attachment



KTC ATTACHMENT OPTIONS



KTC Buckle



KTC Key Ring



KTC No Buckle



KTC attachment is now securely positioned on the shoulder of all Revolution aprons.

300102 THYROID COLLAR COVER



- Keeps thyroid collars sanitary and clean
- Attaches easily to NST-S1 & TCV-S1 collars
- Easy to wash or replace when soiled
- Revolution 700 Series & All Classic nylon colors
- Can be monogrammed for personalization and easy identifier



Protects NST-S1 & TCV-S1



PARTNERING TO KEEP YOUR APRONS CLEAN & SAFE

INFAB is proud to be a global cleaning solutions partner with Clorox.



Excellent product aesthetics

- No harsh chemical odor or fumes
- No fragrance added
- Nonflammable, unlike quaternary ammonium-alcohol-based wipes
- No volatile organic compounds (VOCs)

Broad healthcare surface compatibility

Recommended for plastics and laminated surfaces, whereas isopropyl alcohol will attack some forms of plastic, rubber and coatings*

Surface materials: All INFAB aprons, stainless steel, vinyl, glass, baked enamel, chrome, glazed tile, glazed ceramic, glazed porcelain, porcelain enamel, laminated surfaces, plastic

If light residue appears, it can easily be removed with a clean, damp cloth

Pictures of 1 ft² Infab apron surfaces after treated with 120 product applications over a 10-week period.

Clorox Healthcare® Hydrogen Peroxide Cleaner Disinfectant Wipes

			
Revolution Fabric	Cool Wear	Standard Nylon	Diamond Ripstop

* Based on 30-second non-TB, non-Staphylococcus epidermidis bacteria and virus contact times for general disinfecting on federal master labels as of 2/14/13.



683447
REVOLUTION
SCRUBBLES
APRON CLEANER

Scrubbles apron cleaner safely cleans your aprons of barium, blood and other common radiology related stains. Now with a clean citrus scent and a stronger more efficient formula.

SIZE 32 oz

Also Available
683448
 Case of 12 32 oz bottles with Spray Caps



CLX28
CLOROX SPRAY

Recommended for:
 Multipurpose use on hard and soft surfaces

SIZE 32 oz



CLX24
CLOROX
MULTIPURPOSE
WIPES

Recommended for: Everyday cleaning and disinfecting, daily patient room cleaning, hard, high-touch surfaces

SIZE 6.75" x 9"
QTY 95 ct



CLX26
CLOROX
TERMINAL
WIPES

Recommended for: Terminal cleaning and disinfecting of hard surfaces

SIZE 12" x 11"
QTY 185 ct.



CLX27
CLOROX
TERMINAL
WIPES REFILL

Recommended for: Terminal cleaning and disinfecting of hard surfaces

SIZE 12" x 11"
QTY 185 ct.

NSM NON-SLIP MATERIAL FOR SKIRTS



- Prevents your INFAB skirt from slipping down the waist and causing discomfort
- Can be added to any INFAB skirt by adding part number NSM

SHIN GUARDS



- Reduce radiation exposure to the shins
- Hook and loop closures for easy adjustments

COLORS: Classic nylon colors
SIZES: Small, Medium, Large
CORE: Lightweight Lead, KIARMOR Lead-Free

REV-BAG REVOLUTION APRON BAG



- Revolution fabric
- Plastic bottom to prevent sagging
- Opening on top of bag
- Zipper across the top of bag



909821 APRON BAG



- Classic nylon color options
- Classic tube style design
- Opening on side of bag
- Plastic handle on top of bag



REV-SLV-1 REVOLUTION ATTACHED THYROID COLLAR SLEEVES

- Exclusive Revolution outer fabric
- Additional protection for chest
- Wear under any apron

COLORS: Revolution 700 Series
SIZES: Small, Medium, Large, X-Large, XX-Large
CORE: Lightweight Lead, KIARMOR Lead-Free



FRONT



BACK

REV-SLV-2 REVOLUTION SLEEVE INDIVIDUAL

- Exclusive Revolution outer fabric
- Hook and loop closure elastic strap for easy on/off convenience
- One per order

COLORS: Revolution 700 Series
CORE: Lightweight Lead, KIARMOR Lead-Free



APW AXILLARY PROTECTION WINGS

Increase the protection to your axillary region without sacrificing any mobility or adding weight to your apron.

COLORS: Revolution 700 Series & All Classic Nylon Colors
CORE: Lightweight Lead, KIARMOR Lead-Free



SLV OPTIONAL LEFT OR RIGHT SLEEVE

- Added protection of the arm and shoulder
- .50mm LE
- Available on most INFAB apron models
- Optional removable snap on, permanent sewn on or hook and loop closure attached configuration

COLORS: Revolution 700 Series & All Classic Nylon Colors
ATTACHED: Sewn on, snaps or hook and loop closure
CORE: Lightweight Lead, KIARMOR Lead-Free



THE ORIGINAL BLACK BELT®

The Black Belt® is a 6" wide orthopedic elastic belt that supports your lower back while removing the weight of the apron from your shoulders. Optional KTC Buckle Attachment and/or side snaps.

COLORS: Black
SIZES: X-Small, Small, Medium, Large, X-Large, XX-Large

257879 6" Black Belt® - X-Small
257880 6" Black Belt® - Small
257881 6" Black Belt® - Medium
257882 6" Black Belt® - Large
257883 6" Black Belt® - X-Large
257884 6" Black Belt® - XX-Large



257890 SUSPENDERS

- Fully adjustable suspenders with a handy snap on style.
- One size fits all.

ACCESSORIES



REVOLUTION ELASTIC BACK THINKING CAP

- Revolution outer fabric
- Scatter radiation protection
- Cool Wear moisture-wicking fabric
- Elastic-back for easy on/off convenience

SIZE: Small, Medium, Large, X-Large, XX-Large

COLORS: 700 Series Revolution Colors

PROTECTION: .25mm LE, .35mm LE, .50mm LE

CORE: Lightweight Lead, KIARMOR Lead-Free



400025 REVOLUTION HOOK AND LOOP CLOSURE BACK THINKING CAP

- Revolution outer fabric
- Scatter radiation protection
- Cool Wear moisture-wicking fabric
- Hook & loop back closure for customizable fit

SIZE: One Size Fits All

COLORS: 700 Series Revolution Colors

PROTECTION: .25mm LE, .35mm LE, .50mm LE

CORE: Lightweight Lead, KIARMOR Lead-Free



CLASSIC THINKING CAP WITH TIE STRAPS

- Classic nylon colors
- Head and skull radiation protection
- Scatter radiation protection
- Cool Wear moisture-wicking fabric

SIZE: Small, Medium, Large, X-Large, XX-Large

COLORS: Classic Nylon Colors

PROTECTION: .25mm LE, .35mm LE, .50mm LE

CORE: Lightweight Lead, KIARMOR Lead-Free



DC-25 LEAD-FREE DISPOSABLE THINKING CAP

- Quantity 20/Case
- .25mm LE
- Adjusts to fit all head sizes
- For use by all personnel during any interventional procedure
- 100% lead free for easy disposal

SIZE: One Size Fits All

COLORS: Scatter Armor Blue

PROTECTION: .25mm LE

CORE: KIARMOR Lead-Free

CASSETTE COVERS

Protect Your Cassettes

COMPLETE, HIGHLY EFFECTIVE PROTECTION FROM CONTAMINATION



8" x 10"



10" x 12"



14" x 17"



16" x 19"



24" x 20"

INFAB offers our Cassette Covers in a variety of standard sizes to perfectly fit your needs.

Protect your cassettes in our simple and convenient INFAB Cassette Covers.

Available in boxes of 100 or cases of 500 in an easy-to-use dispenser box.

Cassettes come in contact with blood and other potentially infectious materials.

- Protect your cassettes from cross-contamination
- Protect your patients from infection
- Specially designed to fit your X-ray cassettes
- For use in any imaging area where a risk of contamination exists.

IN-STOCK SAME-DAY SHIPPING

Help Stop the Spread of Infection



The Centers for Disease Control and Prevention (CDC) estimates that roughly 1.7 million hospital-associated infections, from all types of bacteria combined, cause or contribute to 99,000 deaths each year.¹

¹ Klevens RM, Edwards JR, Richards CL, et al. (2007). "Estimating health care-associated infections and deaths in U.S. hospitals, 2002". Public Health Rep 122 (2): 160-6. PMID 17357358.

² Scott II, R. Douglas, (2009). "The Direct Medical Costs of Healthcare-Associated Infections in U.S. Hospitals and the Benefits of Prevention". National Center for Preparedness, Detection, and Control of Infectious Diseases

ZIP TOP CASSETTE COVERS

BOX OF 100/500



Zip Top



- Zip top
- Packed in handy dispenser boxes
- 100 or 500 individual covers per box
- Available in the five cassette sizes
- Always in stock
- Impervious to fluids
- Available in money saving cases of 500.
- Easy to use
- High quality
- Sanitary
- Disposable
- Top grade polyethylene plastic

FLIP TOP CASSETTE COVERS

BOX OF 100/500



Sandwich bag style flap

- “Sandwich” bag style flap
- Packed in handy dispenser boxes
- 100 or 500 individual covers per box
- Available in the five cassette sizes
- Always in stock
- Impervious to fluids
- Available in money saving cases of 500.
- Easy to use
- High quality
- Sanitary
- Disposable
- Top grade polyethylene plastic

Model	Description		Dimensions	Fits Cassette Size
910810-ZT	Cassette Cover Zip Top	Disposable Box of 100	11.25" x 13.25"	8" X 10"
900810-ZT	Cassette Cover Zip Top	Disposable Box of 500	11.25" x 13.25"	8" X 10"
911012-ZT	Cassette Cover Zip Top	Disposable Box of 100	13.375" x 14.75"	10" X 12"
901012-ZT	Cassette Cover Zip Top	Disposable Box of 500	13.375" x 14.75"	10" X 12"
911417-ZT	Cassette Cover Zip Top	Disposable Box of 100	17" x 19.875"	14" X 17"
901417-ZT	Cassette Cover Zip Top	Disposable Box of 500	17" x 19.875"	14" X 17"
911619-ZT	Cassette Cover Zip Top	Disposable Case of 100	19.25" x 22.25"	16" x 19"
901619-ZT	Cassette Cover Zip Top	Disposable Case of 500	19.25" x 22.25"	16" x 19"
912420-ZT	Cassette Cover Zip Top	Disposable Case of 100	20" x 24.625"	24" x 20"
902420-ZT	Cassette Cover Zip Top	Disposable Case of 500	20" x 24.625"	24" x 20"

Model	Description		Dimensions	Fits Cassette Size
910810	Cassette Cover	Disposable Box of 100	11.25" x 13.25"	8" X 10"
900810	Cassette Cover	Disposable Case of 500	11.25" x 13.25"	8" X 10"
911012	Cassette Cover	Disposable Box of 100	13.375" x 14.75"	10" X 12"
901012	Cassette Cover	Disposable Case of 500	13.375" x 14.75"	10" X 12"
911417	Cassette Cover	Disposable Box of 100	17" x 19.875"	14" X 17"
901417	Cassette Cover	Disposable Case of 500	17" x 19.875"	14" X 17"
911619	Cassette Cover	Disposable Box of 100	19.25" x 22.25"	16" x 19"
901619	Cassette Cover	Disposable Case of 500	19.25" x 22.25"	16" x 19"
912420	Cassette Cover	Disposable Case of 100	20" x 24.625"	24" x 20"
902420	Cassette Cover	Disposable Case of 500	20" x 24.625"	24" x 20"



CASSETTE COVERS ROLL & RACK (AVAILABLE SEPARATELY)

- Easy to use
- High quality
- Sanitary
- Disposable
- Top grade polyethylene plastic
- 300 individual covers per roll
- Always in stock
- Impervious to fluids
- Easy installation
- High quality

Fits up to 14" x 17" (35 x 43 cm) cassettes

Model	Description
900500	Roll of 300 Disposable cassette covers
900750	Wall mounted rack for cassette cover rolls

CASSETTE COVER WALL MOUNTED RACK

- Stores 100 covers at your fingertips
- Easy to use
- High quality
- Easy Installation

Model	Description
901825	Cassette cover wall mounted rack for 14" x 17" covers
910829	Cassette cover wall mounted rack for 8" x 10" covers
911132	Cassette cover wall mounted rack for 10" x 12" covers

SCATTER RADIATION SAFETY FOR THE INTERVENTIONALIST & TECH

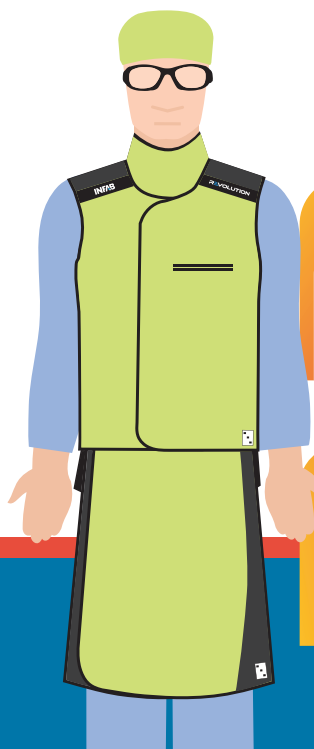

Chest Exposure

SCATTER ARMOR
Reduces Chest Exposure
55-80%

Hand Exposure

SCATTER ARMOR
Reduces Hand Exposure
>49%



SCATTER ARMOR

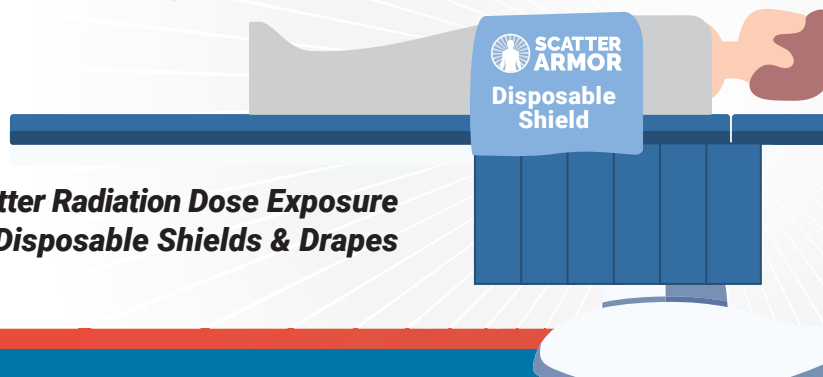

Reduce Scatter Radiation Dose Exposure with Disposable Shields & Drapes

SCATTER ARMOR
Protective Core Material Inside:

KI
KIARMOR
BI-LAYER
LEAD-FREE

The only bi-layer lead-free core material which passes DIN (6875-1), ASTM (F2547-18) and IEC (61331-1-2014) standards from 50 to 150 kVp.



"The scattered radiation from the patient comprises the main source of radiation dose to staff."

Scatter protection

Shields provide scatter radiation protection for radial and many other types of procedures. KIARMOR Bi-Layer is the most protective core material against scatter radiation.

How it works

Sterile Scatter Armor Shields are placed on top of the patient drape to block scatter radiation at the source, creating a scatter-free zone, reducing harmful radiation exposure to the doctor or clinician.

One-time use

Scatter Armor Shields are lead-free and disposable.

Sterile

Packaged individually in sterile packets.

Flexible

Scatter Armor Shields easily mold to the patients body for ease of use and maximum protection

Scatter Radiation Testing

According to ASTM Test Method F2547-18.

Sample Information	50 kV	70 kV	90 kV	110 kV	120 kV	150 kV
Scatter Armor Shield	98.7%	96.1%W	92.0%	87.8%	85.8%	80.1%

Direct Beam Attenuation

Sample Information	60 kV	80 kV	100 kV	120 kV
Scatter Armor Shield	0.967	0.911	0.846	0.788

Absorbent

Scatter Armor Shields utilize the highest absorbency covering material in the industry, critical in heavy fluid situations.

Absorbent Rate	1.3 sec
Weight	2.36 osy / 80 gsm
Absorbent Capacity	686% 16.2osy / 549 gsm

GSM - Grams per square meter, OSY - Ounce per square yard

Scatter Armor Multipurpose Shield

Transradial Access: Left and Right Radial, Shunt, Biliary Drainage, Spinal, Fibroid Embolization

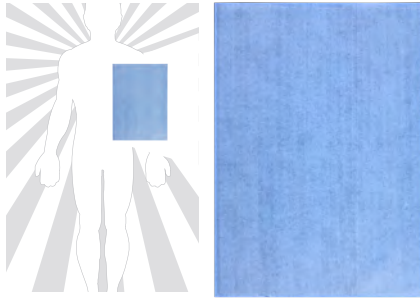

Scatter Armor Angiography Shield

Transfemoral Access: Angiography, Coronary Catheterization

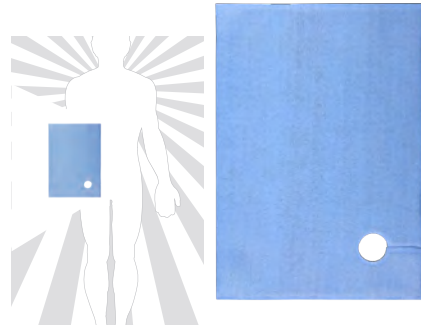

Scatter Armor Biliary Split Shield

Biopsy Procedures, Transjugular Intrahepatic Portosystemic Shunt (TIPS)

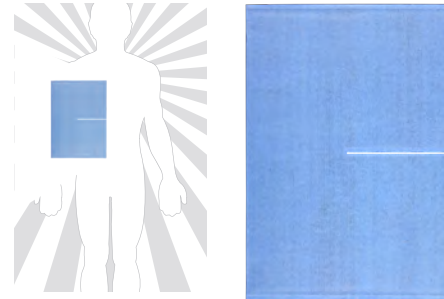

Scatter Armor Peripheral Shield

Peripheral procedures where the access is through the femoral Artery.

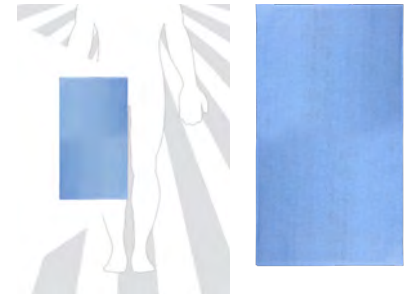

Scatter Armor Multipurpose Shield with Fenestration

Needle Biopsy or Puncture Procedures.

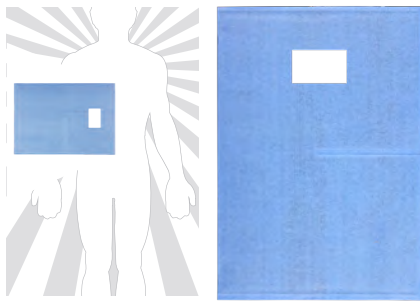

Scatter Armor EP Shield

Subclavian Access: Bi-Ventricular Pacemaker Implants, ICS procedures, and Bi-Ventricular Pacing.

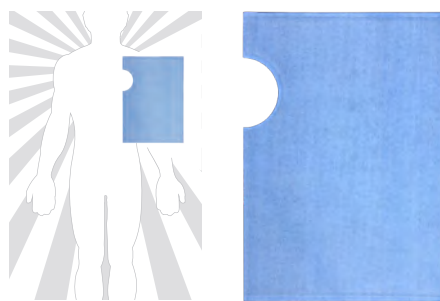

Scatter Armor Dialysis Drape

Dialysis Access and Declothing Procedures.

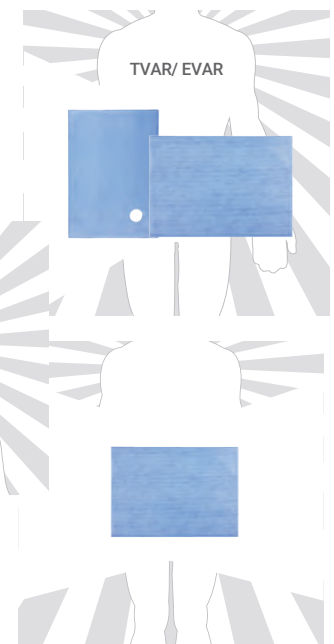
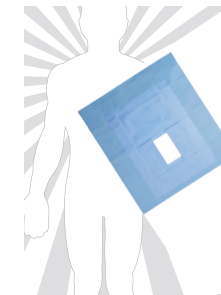

Scatter Armor Shields

Scatter Armor Multi-Purpose Shield, Absorbent, No Fenestration Box	SA-MPS	Box of 15
Scatter Armor Multi-Purpose Shield, Absorbent, No Fenestration Case	SA-MPS-CS	Case of 45
Scatter Armor Multi-Purpose Shield with Fenestration, Absorbent, Rectangular Fenestration Box	SA-MPF	Box of 15
Scatter Armor Multi-Purpose Shield with Fenestration, Absorbent, Rectangular Fenestration Case	SA-MPF-CS	Case of 45
Scatter Armor EP Shield, Absorbent, Scoop Fenestration Box	SA-EPS	Box of 15
Scatter Armor EP Shield, Absorbent, Scoop Fenestration Case	SA-EPS-CS	Case of 45
Scatter Armor Angiography Shield, Absorbent, Circular Fenestration Box	SA-AGS	Box of 15
Scatter Armor Angiography Shield, Absorbent, Circular Fenestration Case	SA-AGS-CS	Case of 45
Scatter Armor Biliary Split Shield, Absorbent, Center Slit Fenestration Box	SA-BSS	Box of 15
Scatter Armor Biliary Split Shield, Absorbent, Center Slit Fenestration Case	SA-BSS-CS	Case of 45
Scatter Armor Dialysis Drapes Box	SA-DDD	Box of 10
Scatter Armor Dialysis Drapes Case	SA-DDD-CS	Case of 30
Scatter Armor Peripheral Shield, Absorbent, No Fenestration Box	SA-PER	Box of 10
Scatter Armor Peripheral Shield, Absorbent, No Fenestration Case	SA-PER-CS	Case of 30

Part Number	Unit
SA-MPS	Box of 15
SA-MPS-CS	Case of 45
SA-MPF	Box of 15
SA-MPF-CS	Case of 45
SA-EPS	Box of 15
SA-EPS-CS	Case of 45
SA-AGS	Box of 15
SA-AGS-CS	Case of 45
SA-BSS	Box of 15
SA-BSS-CS	Case of 45
SA-DDD	Box of 10
SA-DDD-CS	Case of 30
SA-PER	Box of 10
SA-PER-CS	Case of 30



Fits mini-size C Arms, Xi-Scan, Fluoroscanner 3" or 4" FOV. Made from durable, high quality polyethylene materials with abrasion resistance to protect from rips or tears.

4003 - 54" X 63" MINI C ARM DRAPE

- HIGHLIGHTS:** Sterile Product and Latex Free
- QUANTITY:** 40 Drapes (20 drapes per box, 2 boxes included)
- DIMENSIONS:** 54" x 63"
- PACKAGING SIZE:** 10" x 17" x 24"
- TOTAL WEIGHT:** 18 lbs.

8007/CA600 - MINI C ARM DRAPE WITH POLY STRAPS

This item fits mini-size C Arms that is open ended with poly straps. Made from durable, high quality polyethylene materials with abrasion resistance to protect from rips or tears.

- HIGHLIGHTS:** CE Certified, Sterile Product, and Latex Free
- QUANTITY:** 10 Drapes per box
- DIMENSIONS:** 54" x 84"
- PACKING SIZE:** 13" x 7" x 9"
- TOTAL WEIGHT:** 7 lbs.



8003/5406 - FOOT SWITCH COVER

Foot Switch Cover that is clear and fits with Cinch Lock. Made from durable, high quality polyethylene materials with abrasion resistance to protect from rips or tears.

- HIGHLIGHTS:** Sterile Product, and Latex Free
- QUANTITY:** 100 per box
- DIMENSIONS:** 17" x 15"
- PACKAGING SIZE:** 10" x 14" x 22"
- TOTAL WEIGHT:** 8 lbs.



1001 - C ARM DRAPE

This item fits all full-size C Arms. Made from durable, high quality polyethylene materials with abrasion resistance to protect from rips or tears.

- HIGHLIGHTS:** CE Certified, Sterile Product, and Latex Free
QUANTITY: 30 Drapes (15 drapes per box, 2 boxes included)
DIMENSIONS: 42" x 72"
PACKING SIZE: 6" x 12" x 17"
TOTAL WEIGHT: 13.3 lbs.

1002 - C ARM KIT

Contains C-Arm drape, gray Foot Switch Cover, Image Intensifier and X-ray Tube Cover. Fits OEC® 9600/9800/9900 matches OEC® part #00-901501-01 and E9100AG. Includes 5 mounting clips. Made from durable, high quality polyethylene materials with abrasion resistance to protect from rips or tears.

- HIGHLIGHTS:** Sterile Product, and Latex Free
QUANTITY: 20 Drapes per box
DIMENSIONS: Multiply Dimensions in this Kit
PACKAGING SIZE: 7" x 21" x 24"
TOTAL WEIGHT: 16.7 lbs.





MEETS AAMI LEVEL 2 & 3

RECOMMENDED:

ICU, Emergency, Trauma, Airborne, Contact and Droplet Precautions.

MATERIAL:

Non-Woven Spunbond Polypropylene with PE Coating and Elastic Cuffs.

MODEL:

GOWN-D	Large	100 psc/MOQ
GOWN-DXL	X-Large	100 psc/MOQ

DIMENSIONS:

LARGE:

Length 44", Width (Across Shoulders) 26", Sleeve Length 22"

X-LARGE:

Length 44.5", Width (Across Shoulders) 27", Sleeve Length 23.25"



**BERRY
COMPLIANT**

WASHABLE & REUSABLE GOWNS

RECOMMENDED:

ICU, Emergency, Airborne and Contact Precautions.

MATERIAL:

Durable Polyester Microfiber w/Heavy Duty Nylon Tie Straps and Elastic Cuffs.

MODEL:

GOWN-M	Large	100 psc/MOQ
GOWN-MXL	X-Large	100 psc/MOQ

DIMENSIONS:

LARGE:

Length 44", Width (Across Shoulders) 26", Sleeve Length 22"

X-LARGE:

Length 44.5", Width (Across Shoulders) 27", Sleeve Length 23.25"



**BERRY
COMPLIANT**





GLASSES

INFAB offers a complete array of lead glass eye protection and lead glass fitover frames. These attractive, stylish frames all meet the industry standard of 0.75mm lead equivalency radiation safety glass. Lead glass lenses provide protection from harmful radiation exposure.

** Product availability and details may change at any time. For current information and availability, please view our online catalog at <https://www.infabcorp.com/catalog>.*



 <h3>NIKE FRAMES</h3> <p>Complete line of Nike frames. * Check for availability</p>	<h3>PRESCRIPTION</h3> <p>We offer plano, single vision, bifocal, and bifocal progressive options.</p>	<h3>PROTECTION</h3> <p>All glasses have lead protection. * Varies per model</p>	<h3>FRAMES</h3> <p>Wide variety of frames from top designers for all face shapes.</p>	<h3>PERSONALIZE</h3> <p>Engrave a name, initials, phone number, or date.</p>
---	---	---	---	--

NIKE - 7116

Rubber nose pad and temple tip inlays designed to become tackier as the skin perspires for a strong and secure eyewear fit. Core wire memory metal temple tips for on the fly eyewear adjustability and grip. Lightweight, durable nylon frame

- FRAME SIZE:** Universal
- WEIGHT:** 57G
- PRESCRIPTION:** Single-Vision, Plano
- COLORS:** Matte Black - Volt, Matte Dark Grey - Black, Matte Gridiron - Pacific Blue, Matte Black - Space Blue
- PROTECTION** .75mm LE
- INCLUDES** Anti-fog spray, safety strap add-on, protective case

Lens Width: 56.1mm Bridge Width: 15mm Temple Length: 140mm Lens Height: 38.8mm

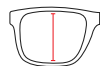
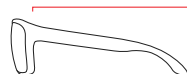
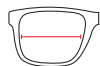

7116-01
Matte Black - Volt



7116-02
Matte Dark Grey - Black



7116-03
Matte Gridiron - Pacific Blue



7116-04
Matte Black - Space Blue



NIKE - 7117

Rubber nose pad and temple tip inlays designed to become tackier as the skin perspires for a strong and secure eyewear fit. Core wire memory metal temple tips for on the fly eyewear adjustability and grip. Lightweight, durable nylon frame

FRAME SIZE:	Universal
WEIGHT:	60G
PRESCRIPTION:	Single-Vision, Plano
COLORS:	Matte Black - Gym Red, Matte Midnight Navy - Obsidian
PROTECTION	.75mm LE
INCLUDES	Anti-fog spray, safety strap add-on, protective case

Lens Width: 54mm

Bridge Width: 16mm

Temple Length: 140mm

Lens Height: 38.9mm

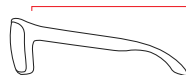

7117-01
Matte Black - Gym Red



7117-02
Matte Midnight Navy - Obsidian

GLASSES



7118-02
Matte Dark Grey - Volt



7118-03
Matte Black



7118-04
Matte Midnight Navy - Wolf Grey



NIKE - 7118

Rubber nose pad and temple tip inlays designed to become tackier as the skin perspires for a strong and secure eyewear fit. Core wire memory metal temple tips for on the fly eyewear adjustability and grip. Lightweight, durable nylon frame

FRAME SIZE:	Universal
WEIGHT:	54G
PRESCRIPTION:	Single-Vision, Plano
COLORS:	Matte Dark Grey - Volt, Matte Black, Matte Midnight Navy - Wolf Grey
PROTECTION	.75mm LE
INCLUDES	Anti-fog spray, safety strap add-on, protective case

Lens Width: 55mm

Bridge Width: 14mm

Temple Length: 140mm

Lens Height: 36.5mm

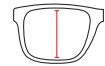
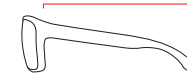
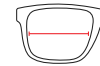

NIKE - 7284

Nike 7284 is a full rim, progressive eligible frame for men and women made of injected plastic. This model features a rounded edges shape, a single bridge, and durable hinges.

FRAME SIZE:	Universal
WEIGHT:	57G
PRESCRIPTION:	Plano, Single Vision
COLORS:	Brown Basalt - Clear Fade, Clear - Cool Grey
PROTECTION:	.75mm LE
INCLUDES:	Anti-fog spray, safety strap add-on, protective case

Bridge Width: 16mm

Temple: 145mm

Lens Width: 54mm

Lens Height: 39mm

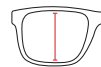
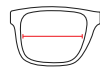
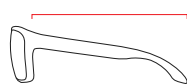
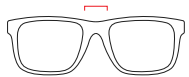

7284-01
Brown Basalt - Clear Fade



7284-02
Clear - Cool Grey



7286-01
Brown Basalt



7286-02
Matte Obsidian - Blue



NIKE - 7286

Nike 7286 is a full rim, progressive eligible frame for men and women made of eco-friendly plastic, bio acetate. This model features a rectangular shape with a single bridge featuring durable hinges.

FRAME SIZE:	Universal
WEIGHT:	68G
PRESCRIPTION:	Plano, Single Vision
COLORS:	Brown Basalt, Matte Obsidian - Blue
PROTECTION:	.75mm LE
INCLUDES:	Anti-fog spray, safety strap add-on, protective case

Lens Width: 56.1mm

Bridge Width: 15mm

Temple Length: 140mm

Lens Height: 38.8mm

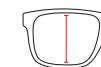
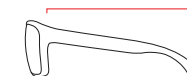

NIKE - ADRENALINE 22

The Adrenaline 22 Nike frame feature a ventilated rubber nose bridge to reduce fogging. In addition, secure wrap temples provide stability, comfort, and added grip. Durable, no-screw hinges stay securely open and closed.

FRAME SIZE:	Universal
WEIGHT:	68G
PRESCRIPTION:	Plano, Single Vision
COLORS:	Matte Dark Grey - Blue, Matte Black - Volt, Matte Black - Grey
PROTECTION:	.75mm LE
INCLUDES:	Anti-fog spray, safety strap add-on, protective case

Lens Width: 64mm

Bridge Width: 15mm

Temple Length: 130mm

Lens Height: 40.4mm

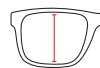
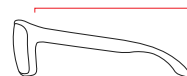
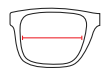

ADRENALINE22-01
Matte Dark Grey - Blue



ADRENALINE22-02
Matte Black - Volt



ADRENALINE22-03
Matte Black - Grey

GLASSES



BRAZEN-02
Matte Black - Military Blue



BRAZEN-04
Shiny Black

NIKE - BRAZEN

The Nike Brazen glasses combine streamlined style, comfort and lightweight durability. They feature a nylon frame and ventilated nose bridge. The Brazen is our most popular model.

FRAME SIZE:	Universal
WEIGHT:	77G
PRESCRIPTION:	Single-Vision, Plano
COLORS:	Matte Black- Military Blue, Shiny Black
PROTECTION	.75mm LE
INCLUDES	Anti-fog spray, safety strap add-on, protective case

Lens Width: 60.5mm

Bridge Width: 16mm

Temple Length: 135mm

Lens Height: 38mm

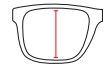
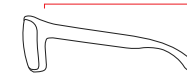
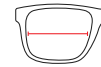

NIKE - BRAZEN FURY

Rubber nose pad and temple tip inlays designed to become tackier as the skin perspires for a strong and secure eyewear fit. Core wire memory metal temple tips for on the fly eyewear adjustability and grip. Lightweight, durable nylon frame

FRAME SIZE:	Universal
WEIGHT:	82G
PRESCRIPTION:	Single-Vision, Plano
COLORS:	Matte Dark Grey - Silver Flash, Matte Midnight Navy, Matte Black - White Red
PROTECTION	.75mm LE
INCLUDES	Anti-fog spray, safety strap add-on, protective case

Lens Width: 55mm

Bridge Width: 14mm

Temple Length: 130mm

Lens Height: 36.5mm

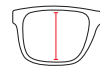
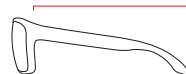
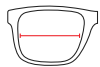

BRAZENFURY-01
Matte Dark Grey - Silver Flash



BRAZENFURY-02
Matte Black - White Red



BRAZENFURY-03
Matte Midnight Navy



BRAZESHADOW-01
Matte Anthracite - Grey



BRAZESHADOW-02
Matte Dark Grey - Red



NIKE - BRAZEN SHADOW

The Nike Brazen Shadow features a rubber nose pad and temple tip inlays designed to become tackier as the skin perspires for a solid and secure eyewear fit. Core wire memory metal temple tips provide on-the-fly eyewear adjustability and grip.

FRAME SIZE:	Universal
WEIGHT:	60G
PRESCRIPTION:	Plano, Single Vision
COLORS:	Matte Anthracite - Grey, Matte Dark Grey - Red
PROTECTION:	.75mm LE
INCLUDES:	Anti-fog spray, safety strap add-on, protective case

Lens Width: 59mm

Bridge Width: 16mm

Temple Length: 130mm

Lens Height: 37.4mm

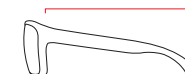

NIKE - CLUB PREMIER

Flexible hinge for adaptable comfort and durability. Adjustable rubber temple arms for enhanced grip and fit. Adjustable nose bridge for a custom fit. Lightweight and durable combination metal and injected frame materials

FRAME SIZE:	Universal
WEIGHT:	77G
PRESCRIPTION:	Plano, Single Vision
COLORS:	Satin Walnut-Bronze, Satin Gunmetal-Blue
PROTECTION:	.75mm LE
INCLUDES:	Anti-fog spray, safety strap add-on, protective case

Lens Width: 56.1mm

Bridge Width: 15mm

Temple Length: 140mm

Lens Height: 38.8mm

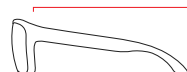
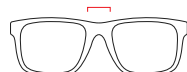
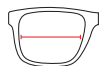

CLUBPREMIER-01
Satin Walnut-Bronze



CLUBPREMIER-02
Satin Gunmetal-Blue

GLASSES



DAWNASCENT-01
Brown



DAWNASCENT-02
Black



NIKE - DAWN ASCENT

Made with minimal materials in a thoughtful design, the Nike Dawn Ascent offers a lightweight frame. Durable, no-screw hinges stay securely open and closed.

FRAME SIZE:	Universal
WEIGHT:	62G
PRESCRIPTION:	Single-Vision, Plano
COLORS:	Brown, Black
PROTECTION	.75mm LE
INCLUDES	Anti-fog spray, safety strap add-on, protective case

Lens Width: 56.9mm

Bridge Width: 17mm

Temple Length: 140mm

Lens Height: 44mm

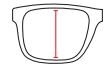
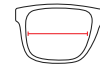

NIKE - MAVERICK

The Nike Maverick glasses are pure performance on the inside. The lightweight frame features ventilation and temple arms that provide a soft, firm grip, ensuring you can wear these for hours at a time.

FRAME SIZE:	Universal
WEIGHT:	78G
PRESCRIPTION:	Single-Vision, Plano
COLORS:	Matte Midnight Navy, Matte Cool Grey, Matte Black Red
PROTECTION	.75mm LE
INCLUDES	Anti-fog spray, safety strap add-on, protective case

Lens Width: 59mm

Bridge Width: 15mm

Temple Length: 145mm

Lens Height: 45.3mm

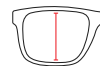
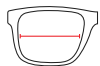

MAVERICK-04
Matte Midnight Navy



MAVERICK-03
Matte Cool Grey



MAVERICK-05
Matte Black-Red



NIKE - MAVERICK RGE

The Nike Maverick RGE sunglasses continue the Maverick legacy with long-wearing comfort and a flexible fit in an updated shape. Full rubber nosebridge and temple tips designed to become tackier as the skin perspires for a strong and secure fit.

FRAME SIZE:	Universal
WEIGHT:	78G
PRESCRIPTION:	Single-Vision, Plano
COLORS:	Matte Midnight Navy- Silver Flash, Matte Black-Grey, Matte Black-Green
PROTECTION	.75mm LE
INCLUDES	Anti-fog spray, safety strap add-on, protective case

Lens Width: 59mm

Bridge Width: 15mm

Temple Length: 145mm

Lens Height: 40.4mm

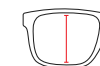
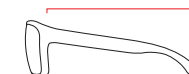

NIKE - PREMIER

Rubber nose pad and temple tip inlays designed to become tackier as the skin perspires for a strong and secure fit.

FRAME SIZE:	Universal
WEIGHT:	64G
PRESCRIPTION:	Single-Vision, Plano
COLORS:	Matte Black, Matte Anthracite - Grey
PROTECTION	.75mm LE
INCLUDES	Anti-fog spray, safety strap add-on, protective case

Lens Width: 60mm

Bridge Width: 13mm

Temple Length: 135mm

Lens Height: 39.3mm

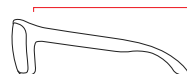
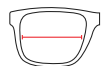

GLASSES



RABID22-01
Matte Black - Red



RABID22-02
Matte Obsidian - Blue



RABID22-03
Matte Black - White



NIKE - RABID 22

Stay clear and focused at every angle in the Nike Rabid 22 lead glasses. Added rubber nose bridge and temples prevent slippage and fogging for optimum performance during procedures.

- FRAME SIZE:** Universal
- WEIGHT:** 60G
- PRESCRIPTION:** Plano, Single Vision
- COLORS:** Matte Black - Red, Matte Obsidian - Blue, Matte Black - White
- PROTECTION:** .75mm LE
- INCLUDES:** Anti-fog spray, safety strap add-on, protective case

Lens Width: 60.5mm

Bridge Width: 16mm

Temple Length: 135mm

Lens Height: 38mm

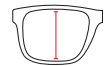
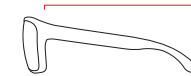
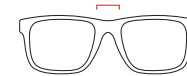
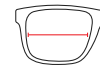

NIKE - WAVE

The Nike Wave lead glasses feature a slim profile. Textured rubber on temple tips adds stability and grip.

- FRAME SIZE:** Universal
- WEIGHT:** 57G
- PRESCRIPTION:** Plano, Single Vision
- COLORS:** Ironstone - Grey, Cave Purple - Grey
- PROTECTION:** .75mm LE
- INCLUDES:** Anti-fog spray, safety strap add-on, protective case

Lens Width: 53mm

Bridge Width: 18mm

Temple Length: 140mm

Lens Height: 42.6mm

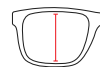
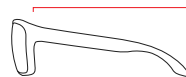
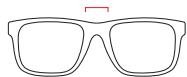

WAVE-01
Ironstone - Grey



WAVE-02
Cave Purple - Grey



GLARE ISSUES?

FOG ISSUES?

COMBAT FOG AND GLARE

New specialized lens coating, Anti-Fog or Anti-Reflective to choose from!

DESCRIPTION:

Lens coatings are available on most glasses and will also increase durability and resistance to scratches.

AVAILABILITY

These coatings are only available on Plano and Single vision prescription glasses. *Only one coating is possible per pair of glasses

AR • Anti-Reflective Coating



Highlights:

- Reduce glare from screens
- Less eye fatigue
- Durable and resistant to scratches

AF • Anti-Fog Coating



Highlights:

- Enhance vision
- Eliminate fog
- Increase visibility

GUCCI

RADIATION PROTECTION GLASSES



GG0343-007

Sylvie and Web concept glorified by the tri-colored temples with the House tones and new ones. Easy to wear rectangular frame characterized by dark shades in strong contrast with the colored temples. Soft spoken branding with golden Gucci lettering logo on the temple.

- FRAME SIZE:** 57mm - 18mm - 150mm
- PRESCRIPTION:** Plano, Single Vision, Most Bi-Focal & Bi-Focal Progressive
- COLORS:** Multicolor
- WEIGHT:** 79 G
- PROTECTION:** .75 mm LE
- INCLUDES:** Case, Cloth & Anti-Fog Spray

Lens Width: 57mm

Bridge Width: 18mm

Temple Length: 150mm

Lens Height: 40mm

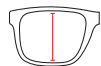
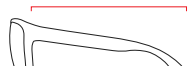
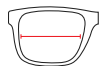

GG0343-007
Multicolor

GG0343-008



The Gucci GG0343-008 features a rectangular shape. The temples feature signature Gucci color bands and subtle branding.

Frame Size	57mm - 18mm - 150mm
Prescription	Plano, Single Vision, Most Bi-Focal & Bi-Focal Progressive
Colors	Multicolor Havana
Weight	79 G
Protection	.75 mm LE
Includes	Case, Cloth & Anti-Fog Spray

Lens Width: 57mm

Bridge Width: 18mm

Temple Length: 150mm

Lens Height: 40mm



GG0381-007

Masculine Club Master shape. Web and the Sylvie motifs enameled on wirecore for a see-through effect. Classic colour palette with black browlines contrast with the gold metal frame.

FRAME SIZE:	57mm - 18mm - 145mm
PRESCRIPTION:	Plano, Single Vision, Most Bi-Focal & Bi-Focal Progressive
COLORS:	Black
WEIGHT:	87 G
PROTECTION:	.75 mm LE
INCLUDES:	Case, Cloth & Anti-Fog Spray



Lens Width: 57mm

Bridge Width: 18mm

Temple Length: 145mm

Lens Height: 45mm



GG0426-006

Masculine rectangular light metal shape, easy to wear. Rubber temples embellished with Gucci Web Gros Grain and Gucci lettering Logo. Dark tones for a masculine color palette.

- FRAME SIZE:** 58mm - 18mm - 145mm
Alternative Fit
- PRESCRIPTION:** Plano, Single Vision,
Most Bi-Focal & Bi-Focal Progressive
- COLORS:** Brown
- WEIGHT:** 73 G
- PROTECTION:** .75 mm LE
- INCLUDES:** Case, Cloth & Anti-Fog Spray

Lens Width: 58mm Bridge Width: 15mm Temple Length: 145mm Lens Height: 42mm



GG0426-006
Brown

GG0560-005

Vented radiation protection goggle with neoprene foam on the inside designed to protect against fluid splashing and perspiration. Easy to adjust with elastic head band. Prescription compatible (for most Rx). Lightweight and comfortable. Large lens area for maximum protection.

- FRAME SIZE:** 55mm - 20mm - 145mm
- PRESCRIPTION:** Plano, Single Vision,
Most Bi-Focal & Bi-Focal Progressive
- COLORS:** Black/Crystal
- WEIGHT:** 73 G
- PROTECTION:** .75 mm LE
- INCLUDES:** Case, Cloth & Anti-Fog Spray

Lens Width: 55mm Bridge Width: 20mm Temple Length: 145mm Lens Height: 41.6mm



GG0560-005
Black / Crystal

GG0640-001

Gucci Collection Iconic shapes interpreted in a easy to wear and elegant mood. Rectangular frame. Gucci interlocking logo on temples framed by two silver-coloured bars. Classic color palette.

- FRAME SIZE:** 55mm - 16mm - 145mm
Alternative Fit
- PRESCRIPTION:** Plano, Single Vision,
Most Bi-Focal & Bi-Focal Progressive
- COLORS:** Black
- WEIGHT:** 73 G
- PROTECTION:** .75 mm LE
- INCLUDES:** Case, Cloth & Anti-Fog Spray

Lens Width: 55mm Bridge Width: 16mm Temple Length: 145mm Lens Height: 38.7mm

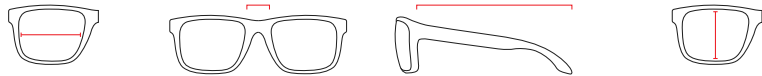

GG0640-001
Black



GG0640-002
Havana

GG0640-002

Gucci Collection Iconic shapes interpreted in a easy to wear and elegant mood. Rectangular frame. Gucci interlocking logo on temples framed by two gold-coloured bars. Classic color palette.

- FRAME SIZE:** 55mm - 16mm - 145mm
Alternative Fit
- PRESCRIPTION:** Plano, Single Vision,
Most Bi-Focal & Bi-Focal Progressive
- COLORS:** Havana
- WEIGHT:** 73 G
- PROTECTION:** .75 mm LE
- INCLUDES:** Case, Cloth & Anti-Fog Spray

Lens Width: 55mm Bridge Width: 16mm Temple Length: 145mm Lens Height: 38.7mm





GG0758-001
Black

GG0758-001

Best Seller shape interpreted in a modern, light and high quality version. Rectangular shape. Temples with Gucci logo. Classic color palette with solid and transparent tones.

FRAME SIZE	56mm - 17mm - 150mm Alternative Fit
PRESCRIPTION	Plano, Single Vision, Most Bi-Focal & Bi-Focal Progressive
COLORS	Black
WEIGHT	65 G
PROTECTION	.75 mm LE
INCLUDES	Case, Cloth & Anti-Fog Spray

Lens Width: 56mm

Bridge Width: 17mm

Temple Length: 150mm

Lens Height: 38.6mm

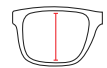
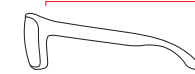
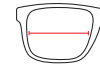

GG0758-003

Best Seller shape interpreted in a modern, light and high quality version. Rectangular shape. Temples with Gucci logo. Classic color palette with solid and transparent tones.

FRAME SIZE:	56mm - 17mm - 150mm Alternative Fit
PRESCRIPTION:	Plano, Single Vision, Most Bi-Focal & Bi-Focal Progressive
COLORS:	Grey
WEIGHT:	65 G
PROTECTION:	.75 mm LE
INCLUDES:	Case, Cloth & Anti-Fog Spray



GG0758-003
Grey

Lens Width: 56mm

Bridge Width: 17mm

Temple Length: 150mm

Lens Height: 38.6mm

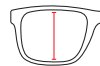
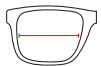

GG0692-004

Modern, light and high-quality surgical stainless steel Gucci frame, rectangular masculine shape, and Gucci logo on temples.



GG0692-004
Black

FRAME SIZE	57mm - 16mm - 150mm
PRESCRIPTION	Plano, Single Vision, Most Bi-Focal & Bi-Focal Progressive
COLORS	Black
WEIGHT	83 G
PROTECTION	.75 mm LE
INCLUDES	Case, Cloth & Anti-Fog Spray

Lens Width: 57mm

Bridge Width: 16mm

Temple Length: 150mm

Lens Height: 38.2mm

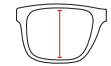
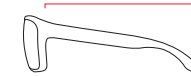

GG1046-004

Modern, light and high quality Gucci frame with exclusive spring hinge, rectangular shape, and Gucci logo on temples.

Frame Size	55mm - 18mm - 150mm
Prescription	Plano, Single Vision, Most Bi-Focal & Bi-Focal Progressive
Colors	Black
Weight	75 G
Protection	.75 mm LE
Includes	Case, Cloth & Anti-Fog Spray



GG1046-004
Black

Lens Width: 55mm

Bridge Width: 18mm

Temple Length: 150mm

Lens Height: 38.2mm

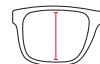
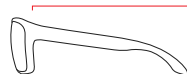
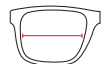

GLASSES



832001
Tortoise



832000
Black

FITOVERS ECOFIT

Wrap around Radiation protection with .35mm LE side shield protection. The Hypo-allergenic Crystal Nylon™ Frame is designed to be worn over prescription eyewear

FRAME SIZE: Universal
WEIGHT: 90 G
PRESCRIPTION: Plano
COLORS: Black, Tortoise
PROTECTION .75mm LE
INCLUDES: Anti-fog spray, safety strap add-on, protective case

Lens Width: N/Amm

Total Width: 135mm

Temple Length: N/Amm

Lens Height: 41mm

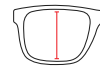
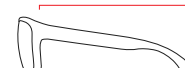
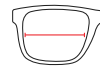

FITOVERS LOTUS

Fits frames not exceeding 141mm width x 40mm height. Wrap around Radiation protection. Hypo-allergenic Crystal Nylon™ Frame. Designed to be worn over medium, oval, or round prescription eyewear frame shapes.

FRAME SIZE: Universal
WEIGHT: 84G
PRESCRIPTION: Plano
COLORS: Matte Black, Smoke Marble, Claret Stripe
PROTECTION .75mm LE
INCLUDES Anti-fog spray, safety strap add-on, protective case

Lens Width: N/Amm

Total Width: 141mm

Temple Length: N/Amm

Lens Height: 40mm

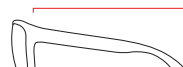
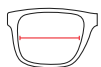

800304
Matte Black



800306
Smoke Marble



800307
Claret Stripe

FITOVERS ORION



ORION-02
Blue Marble



ORION-01
Black

Fits frames not exceeding 140mm width x 43mm height. Wrap around radiation protection. Hypo-allergenic Crystal Nylon™ Frame. Designed to be worn over medium prescription eyewear frame shapes. Non Rx.

FRAME SIZE:	Universal
WEIGHT:	84G
PRESCRIPTION:	Plano
COLORS:	Black, Blue Marble
PROTECTION	.75mm LE
INCLUDES	Anti-fog spray, safety strap add-on, protective case

Lens Width: N/Amm



Total Width: 140mm



Temple Length: N/Amm

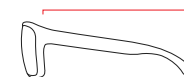

Lens Height: 43mm



FITOVERS RAZOR

Fits frames not exceeding 132mm width x 38mm height. Wrap around Radiation protection, Hypo-allergenic Crystal Nylon™ Frame. Designed to be worn over small, square, or rectangle prescription eyewear frame shapes.

FRAME SIZE:	Universal
WEIGHT:	82G
PRESCRIPTION:	Plano
COLORS:	Matte Black, Gun Metal, Olive-Charcoal
PROTECTION	.75 mm LE
INCLUDES	Anti-fog spray, safety strap add-on, protective case

Lens Width: N/Amm

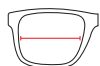

Total Width: 132mm



Temple Length: N/Amm

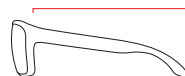

Lens Height: 38mm



800230
Matte Black



800240
Gun Metal



800235
Olive-Charcoal

GLASSES



800076
Blue



800077
Plated Silver



800079
Shiny Black

ACHILLES

Vented radiation protection goggle with neoprene foam on the inside designed to protect against fluid splashing and perspiration. Easy to adjust with elastic head band. Prescription compatible (for most Rx). Lightweight and comfortable. Large lens area for maximum protection.

FRAME SIZE:	Universal
WEIGHT:	69G
PRESCRIPTION:	Plano, Single Vision (-SV), Bifocal (-BF), Bifocal Progressive (-BF-P)
COLORS:	Blue, Red, Plated Silver, Shiny Black
PROTECTION	.75mm LE
INCLUDES	Anti-fog spray, safety strap add-on, protective case

Lens Width: 53mm

Bridge Width: 17mm

* Frame width: 128mm

Lens Height: 35mm

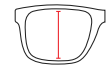
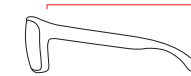

CYBER FLEX

High Quality Safety Glasses. Adjustable temple bar. Large viewing area. Side protection, 0.50mm with an oversized protective lens area.

FRAME SIZE:	Universal
WEIGHT:	95.4G
PRESCRIPTION:	Single Vision, Plano
COLORS:	Clear-Blue
PROTECTION	.75mm LE
INCLUDES	Anti-fog spray, safety strap add-on, protective case

Lens Width: 59mm

Bridge Width: 19mm

Temple Length: 135-150mm

Lens Height: 40mm

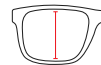
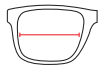

683206-S
Clear-Blue

EVO



EVO-01
Black



The Evo includes permanent side shields with an adjustable nosepiece. These maximum protection glasses come with .75mm protection and a stylish, sleek look. Side shields for maximum protection. Clear inside plastic frame. Adjustable nose piece. EVO is an RX-friendly frame, and it will hold an SV, BF and BF-P.

FRAME SIZE:	Universal
WEIGHT:	90.4G
PRESCRIPTION:	Plano
COLORS:	Matte Black
PROTECTION	FRONT: .75mm LE, SIDE: .50mm LE
INCLUDES	Anti-fog spray, safety strap add-on, protective case

Lens Width: 55mm

Bridge Width: 17mm

Temple Length: 140mm

Lens Height: N/Amm

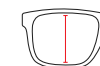
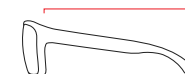

FLIP TOP

"Flip Top" radiation goggles are an all new product, designed to reduce scatter radiation by as much as 70% (actual reduction is dependent upon imaging technique used) Lightweight, Large protective area: 52mm x 154mm. Flips open when not needed. Adjustable nose bridge. Can be used as a stand alone radiation reduction goggle or fits easily over your existing glasses.

FRAME SIZE:	Universal
WEIGHT:	44G
PRESCRIPTION:	Plano
COLORS:	Amber
PROTECTION	.07mm LE
INCLUDES	Anti-fog spray, safety strap add-on, protective case

Lens Width: N/Amm

Total Width: 154mm

Temple Length: N/Amm

Lens Height: 52mm

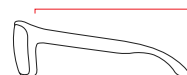
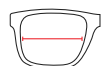

800275
Amber



GLASSES



860001
Shiny Black



683260
Silver

INCREDIBLES

The Incredibles are a stylish wrap around safety frame made of TR-90 high impact resistant plastic. ANSI Z87.1+ approved, lightweight and comfortable. Includes a high quality carrying case. Incredibles glasses are .75mm LE and available from stock in non-prescription.

FRAME SIZE:	Universal
WEIGHT:	75G
PRESCRIPTION:	Single-Vision, Plano
COLORS:	Shiny Black, Silver
PROTECTION	.75mm LE
INCLUDES	Anti-fog spray, safety strap add-on, protective case

Lens Width: 62mm

Bridge Width: 18mm

Temple Length: 145mm

Lens Height: 36mm

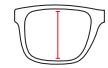
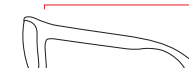
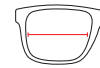

MAXX 30

Prescription compatible (for most Rx), First protective eyewear to receive the American Ophthalmology Associations seal of acceptance. Meets ANSI Z87.1+ standards along with ASTM F803 impact resistance standards. Temple bars and nose bridge have soft rubberized padding for extra comfort, lightweight and comfortable, large lens area for maximum protection Bifocal Progressive Rx frame (requires segment height).

FRAME SIZE:	Universal
WEIGHT:	63G
PRESCRIPTION:	Plano, Single Vision (-SV), Bifocal (-BF), Bifocal Progressive (-BF-P)
COLORS:	Black, Red, Silver, Blue
PROTECTION	.75mm LE
INCLUDES	Anti-fog spray, safety strap add-on, protective case

Lens Width: 53mm

Bridge Width: 17mm

Temple Length: 130mm

Lens Height: 35mm

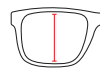
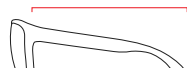
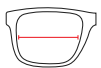

Optional Side Protection

830250
Black



830251
Red



830252
Silver



800070
Blue

PREMIUM WRAPS

The Premium Wraps feature a large prescription compatible front lens area with maximum radiation protection and side lens for peripheral vision. The frames include spring hinges, formable side temple bars and a fully adjustable nose piece.



683213
Tortoise Shell

FRAME SIZE:	Universal
WEIGHT:	97.3G
PRESCRIPTION:	Plano, Single Vision
COLORS:	Tortoise Shell
PROTECTION	FRONT: .75mm LE, SIDE: .75mm LE
INCLUDES	Anti-fog spray, safety strap add-on, protective case

Lens Width: 57mm

Bridge Width: 19mm

Temple width: 140mm

Lens Height: 59mm

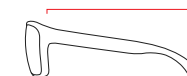

ZION

The Zion features a large protection area including permanent side shields. These heavy duty glasses are a combination of stylish and protective. Wrap around frame style. Protection on the sides provides a maximum protection of .75mm.

FRAME SIZE:	Universal
WEIGHT:	91.4G
PRESCRIPTION:	Plano
COLORS:	Matte Black
PROTECTION	FRONT: .75mm LE, SIDE: .75mm LE
INCLUDES	Anti-fog spray, safety strap add-on, protective case

Lens Width: 56mm

Bridge Width: 19mm

Temple Length: 135mm

Lens Height: N/Amm

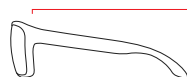
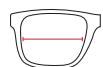

ZION-01
Matte Black





870002
Red



870001
Silver



870003
Black

ZONE

Rubber nose pads and rubberized temple bars. Wrap around design. Lightweight and comfortable. Large lens area for maximum protection.

- FRAME SIZE:** Universal
- WEIGHT:** 75G
- PRESCRIPTION:** Plano
- COLORS:** Black, Silver, Red
- PROTECTION:** .75mm LE
- INCLUDES:** Anti-fog spray, safety strap add-on, protective case

Lens Width: 60mm

Bridge Width: 18mm

Temple Length: 135mm

Lens Height: 36mm

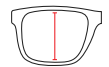
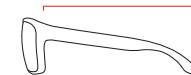

RADIATION PROTECTION SURGICAL GLOVES



SURGICAL



RADIOLOGY

**LEAD-FREE, POWDER-FREE, AND LATEX-FREE
THINNEST RADIATION GLOVE ON THE MARKET**

The INFAB Radiation Protection Surgical Gloves are lead-free, latex-free, and powder-free and reduce radiation exposure during fluoroscopy procedures while offering superb dexterity, sensitivity, and tactile feel.



Protection During Fluoroscopy:

- Interventional Cardiology
- Interventional Radiology
- EVAR / TEVAR Procedures
- Urological Stents
- Gastro ERCP
- C-Arm Fluoroscopy
- Pain Management
- Electro physiological (EP) Studies
- Ortho, Trauma, and Spine Surgery

Radiation Protection Surgical Gloves

Model Number	Size
797165	6.5
797170	7
797175	7.5
797180	8
797185	8.5
797190	9

Glove Thickness	.07 in. (0.18 mm)	
Color	Black	
Sizes	6.5, 7.0, 7.5, 8.0, 8.5, 9.0	
Source Potential	Aluminum Half-Value Level	Measured Attenuation
60 kVp	2.9	56.5%
80 kVp	4.0	47.1%
100 kVp	5.1	41.6%
120 kVp	6.2	37.7%

* Tested to ASTM F2547-06

* Lead Equivalency: .05 mm Pb per RQR 6 IEC 61267



- Lead-free
- Sterile
- Reduces exposure during fluoroscopy
- Greater flexibility, dexterity and sensitivity
- Maintains tactile feel
- Natural latex-free
- Powder-free to avoid contamination

GLOVES



NEOPRENE GLOVES

Designed to reduce the amount of scattered radiation exposure to the hands from the primary X-ray beam during radiological procedures. These gloves are Latex-Free, Lead-Free, and of course radiation protected.

COLORS: White

ATTENUATION: 60kVp:38%, 80kVp:30%, 100kVp:24%, 120kVp 19% (Cuff)
60kVp:49%, 80kVp:40%, 100kVp:33%, 120kVp 27% (Fingertip)
Direct beam energy levels. May vary by +/- 5%

HIGHLIGHTS:

- Lead-free
- Latex-free
- Powder-free
- High sensitivity
- 30% reduction of direct beam radiation transmitted at 100 kVp
- Packed in sterile pouch
- Shipped from stock

MODEL NUMBER:	SIZE:
683310	6.5
683315	7
683320	7.5
683325	8
683330	8.5
683335	9

REVOLUTION GLOVES

INFAB's Exclusive Revolution Radiation Protection gloves are designed to be the most comfortable, flexible, lightweight and protective gloves. Revolution Radiation Protection Gloves come with tactile grip finger tips. The tactile grip helps with keeping a strong grasp on instruments during a long procedure.

COLORS: Black

ATTENUATION: Light (60kV:40%, 80kV:35%, 100kV:30%)
Medium (60kV:68%, 80kV:61%, 100kV:54%)
Heavy (60kV:75%, 80kV:69%, 100kV:63%)

HIGHLIGHTS:

- Latex-free
- Powder-free
- Tactile grip
- Tactile sensitivity
- Sterile
- Maximum tactile sensitivity
- Anatomical fit

LIGHT MODEL NUMBER:	SIZE:	MEDIUM MODEL NUMBER:	SIZE:	HEAVY MODEL NUMBER:	SIZE:
700165	6.5	735065	6.5	775065	6.5
700170	7	735070	7	775070	7
700175	7.5	735075	7.5	775075	7.5
700180	8	735080	8	775080	8
700185	8.5	735085	8.5	775085	8.5
700190	9	735090	9	775090	9

REVOLUTION MAXI-FLEX GLOVES

The perfect way to ensure your hands and lower forearms are fully protected by the most flexible, comfortable radiation protection gloves on the market. Comfortable fit with maximum dexterity. Soft removable, washable and replaceable inner liners reduce odors and allow for washing. Durable outer covers can be replaced. Revolution Maxi-Flex 5 Finger Lead Gloves come exclusively in our Revolution fabric, the softest and most comfortable material available for radiation protection.



712- Ducks Green



707- Yellow



715- Orange



719- Coral



704- Pink



701- Red



713- Tide Red



702- Fuchsia



710- Purple



705- Navy



718- Royal Blue



708- Sky Blue



717- Light Blue Serenity



714- Jewelry Box Blue



706- Teal



709- Grey



700- Black

SIZES:

15"

COLORS:

Revolution Colors

PROTECTION:

.50mm LE

OPTIONS:

683300- Gloves (Pair)

683306- Replacement Liners

683307- Replacement Covers

HIGHLIGHTS:

- Revolution Fabric in solid colors
- Tough, durable outer coverings
- Soft, flexible and comfortable
- Removable, washable and replaceable "Cool Wear" moisture-wicking inner liners
- Replaceable outer covers



711- White



SPLIT PALM MITTENS

Outstanding manual dexterity. Slotted palm allowing the fingers to be extended from the mitten. Complete hand and lower arm protection.

- SIZES:** 15"
- COLORS:** Revolution Colors
- PROTECTION:** .50mm LE
- OPTIONS:**
 - 683700- Open Palm Mittens (Pair)
 - 683701- Open Palm Mittens (Right Only)
 - 683702- Open Palm Mittens (Left Only)

SPLIT PALM MITTENS WITH FLAP

Special flap to close the opening in the mitten when finger extension is not desired. Outstanding manual dexterity. Slotted palm allowing the fingers to be extended from the mitten. Complete hand and lower arm protection.

- SIZES:** 15"
- COLORS:** Revolution Colors
- PROTECTION:** .50mm LE
- OPTIONS:**
 - 683710- Open Palm Mittens (Pair)
 - 683711- Open Palm Mittens w/Flap (Right Only)
 - 683712- Open Palm Mittens w/Flap (Left Only)





684000 Hand Shields

HAND SHIELDS - 684000

Durable, comfortable and fully adjustable shields. Full upper hand protection with total mobility of the hand and fingers. Finger retainers are constructed of durable 1" polypropylene webbing. Hook and loop closure at wrist offers plenty of adjustment.

SIZE: One Size Fits All

COLORS: Blue

PROTECTION: .50mm LE

HIGHLIGHTS:

- Durable, comfortable and fully adjustable
- Total mobility of the hand and fingers
- Hook and loop closure

MAXI-FLEX MITTENS

The perfect way to ensure your hands and lower forearms are fully protected by the most flexible, comfortable radiation protection mitten on the market.

SIZE: 15"

COLORS: Revolution Colors

PROTECTION: .50mm LE

OPTIONS: 683303- MAXI-FLEX Mittens (Pair)
683308- MAXI-FLEX Mittens Replacement Liners
683309- MAXI-FLEX Mittens Outer Cover

HIGHLIGHTS:

- Soft, flexible and comfortable
- Removable, washable and replaceable "Cool Wear" moisture-wicking inner liners
- Replaceable outer covers
- Removable, washable and replaceable inner liners



BARRIERS

INFAB high-quality radiation protection barriers are purpose-built to handle the daily rigors of hospital use. These smooth-rolling and easy-maneuvering barriers offer the highest levels of radiation protection in the industry.

WINDOW

Your choice of 2.0mm LE lead glass, completely encased with acrylic panels to help prevent damage and breakage, or .50mm LE acrylic.

CASTERS

Hospital-grade swivel locking casters for easy mobility and positive and secure placement.

COLORS

Standard white, black or grey.
Custom options available. Upcharge applies.

CUSTOMIZATION

- Color: Frames can be custom powder coated in any pantone color (upcharge applies)
- Size: INFAB can produce barriers to your specification
- Logo: Add your logo to any barrier
- Stainless Steel: Optional stainless steel frame

FRAME

Powder coated steel frame. Precision TIG welded for years of trouble-free service completely enclosing the leaded glass panel for increased durability and safety.

PROTECTION

2.0mm LE lead glass or .50mm LE acrylic window
1.5mm LE base panel
2 0.75mm LE Curtains (1.5mm LE.)



Stationary floor and wall-mounted barriers, built to your specifications.





EVO-460 FLAT PACK BARRIER

WINDOW:	Acrylic .50mm Pb LE
WINDOW SIZE:	24" H x 30" W
OVERALL SIZE:	72" H x 34½" W x 25" D
FLOOR CURTAIN:	Optional
COLOR:	Aluminum Finish
WHEELS:	4 swivel casters, 2 with brakes
SHIPPING:	BOX: 41½" x 51½" x 11½", 135 lbs / 61.24 kg

- Lightweight & Durable Aluminum Frame
- Wheels for Easy Mobility
- Wheel Locking System for Stability
- Compact Shipping Box
- Cost-Efficient Shipping
- Easy 3-Step Assembly





683462 TILTED BARRIER WITH REACH-THROUGH CURTAIN

WINDOW:	2.0mm LE Lead Glass or .50mm LE Acrylic
WINDOW SIZE:	24" H x 30" W
OVERALL SIZE:	70" H x 34" W X 25" D
CURTAIN SIZE:	20" H x 30" W
COLORS:	Standard white, grey or black. Custom options available.
FRAME:	Metal, Stainless Steel (Upgrade)
SHIPPING:	Crate: 73" x 30" x 43", 355 lbs / 161.03 kg

- Tilted design for better view
- Powder coated steel frame
- Acrylic impact panels, enclosed in a precision TIG welded frame for years of trouble-free service, completely enclosing the leaded glass panel for increased durability and safety
- 2 high-quality hospital grade locking casters
- 1.50mm LE opaque base covered in "Sintra" plastic for easy cleaning and durability
- Modular parts can be easily replaced, including the glass if needed.
- Ergonomical viewing area
- Shipping worldwide by ground, air or sea freight



REACH-THROUGH CURTAIN



076994 PHYSICIAN PROTECTION MOBILE SCREEN

A unique new design for operating physicians that allows unparalleled protection for close-to-table studies. Sturdy, yet thoughtfully engineered with a small footprint so it can easily be positioned exactly where you want it for maximum scatter radiation protection.

- WINDOW:** .50mm LE acrylic
- WINDOW SIZE:** 45.7" W x 18.7" H
- OVERALL SIZE:** Minimum Height: 57.5" (146 cm), Maximum Height: 69.7" (177 cm)
Base: 27" W x 24" D
- FRAME COLORS:** Standard white, grey or black. Custom options available.
- CURTAIN COLORS:** Standard Revolution grey. Custom options available.
- FRAME:** Metal, Stainless Steel (Upgrade)
- SHIPPING:** Pallet: 48" x 40" x 12", 160 lbs / 72.57 kg

- Screen height adjustable by 11.8" (30 cm). Includes safety catch to set in desired position
- .50mm LE double protective curtain
- Horizontal position can be adjusted to fit close to table
- 2 high-quality hospital grade locking casters
- Powder coated steel frame
- Modular parts can be easily replaced, including the lead acrylic if needed.
- Shipping worldwide by ground, air or sea freight



076994-IT
Optional 9"x 24" Stainless Steel Instrument Tray





REV-PMC REVOLUTION MOBILE CURTAIN

A unique new design for operating physicians that allows unparalleled protection for close-to-table studies. Sturdy, yet thoughtfully engineered with a small footprint so it can easily be positioned exactly where you want it for maximum scatter radiation protection.

SIZE:	Adjustable height 43½" - 66" Base: 34" W x 25" D
CURTAIN:	38"H x 30"W .50mm LE lead curtain with grey Revolution fabric
FRAME COLORS:	Standard white, grey or black. Custom options available.
CURTAIN COLORS:	Standard Revolution grey. Custom options available.
FRAME:	Powder Coated Steel, Stainless Steel (Upgrade)
SHIPPING:	Box: 13" x 42" x 9", 45 lbs / 20.41 kg Box: 26" x 30" x 8", 30 lbs / 13.60 kg



- Special 4 caster T-bar base design to stabilize the unit
- Smooth easy maneuvering
- Special spring mechanism allows for easy raising, lowering, and automatically holding shield
- .50mm LE double protective curtain
- 2 high-quality hospital grade locking casters

Spring mechanism makes it easy to raise and lower and stay in place.



REV-SPMC REVOLUTION SOLID PANEL MOBILE CURTAIN

- SIZE:** 56" H x 30" W
- CURTAIN:** 30" x 30"
- PROTECTION:** REV-SPMC10 1.0mm LE
REV-SPMC50 .50mm LE
- FRAME COLORS:** Standard white, grey or black. Custom options available.
- CURTAIN COLORS:** Standard Revolution grey. Custom options available.
- FRAME:** Powder Coated Steel, Stainless Steel (Upgrade)
- SHIPPING:** Box: 21" x 21" x 10", 18 lbs / 8.17 kg
Box: 16" x 33" x 7", 28 lbs / 12.7 kg

- Heavy-duty hospital-grade purpose-built unit.
- Adjustable height between 37" and 56"
- 30" wide by 30" tall lead vinyl curtain
- 2 high-quality hospital grade locking casters
- Smooth and easy maneuvering



Adjustable height locking system from 37" to 56"





REV-MC ECONOMY MOBILE CURTAIN

SIZE:	66" H x 28" W
CURTAIN:	30" x 30" .50mm LE curtain with grey Revolution fabric
FRAME COLORS:	Standard white, grey or black. Custom options available.
CURTAIN COLORS:	Standard Revolution grey. Custom options available.
FRAME:	Powder Coated Steel, Stainless Steel (Upgrade)
SHIPPING:	Box: 24" x 30" x 12", 20 lbs / 9.07 kg Box: 6" x 6" x 6", 27 lbs / 12.25 kg

- Raise and lower shield
- Smooth easy maneuvering
- .50mm LE double protective curtain
- 2 high-quality hospital grade locking casters





683461 TILTED MOBILE BARRIER

- WINDOW:** 2.0mm LE Lead Glass or .50mm LE Acrylic
- WINDOW SIZE:** 24" H x 30" W
- OVERALL SIZE:** 70" H x 34 1/4" W X 25" D
- COLORS:** Standard white, grey or black. Custom options available.
- FRAME:** Metal, Stainless Steel (Upgrade)
- SHIPPING:** Crate: 73" x 30" x 43", 355 lbs / 161.03 kg

- Powder coated steel frame
- Acrylic impact panels, enclosed in a precision TIG welded frame for years of trouble-free service, completely enclosing the leaded glass panel for increased durability and safety
- 2 high-quality hospital grade locking casters
- 1.50mm LE opaque base covered in "Sintra" plastic for easy cleaning and durability
- Modular parts can be easily replaced, including the glass if needed.
- Ergonomical viewing area
- Shipping worldwide by ground, air or sea freight

Tilted design for better view





076993 TECHNICIAN PROTECTION MOBILE SCREEN

The Technician Protection Mobile Screen can be easily raised and lowered by hand and stays in position thanks to the perfectly counter-balanced internal springs. The high quality steel construction and stainless springs provide a lifetime of trouble-free use.

SIZE RAISED: 73" H x 31" W x 20 1/2" D

SIZE LOWERED: 44" H x 31" W x 20 1/2" D

WINDOW SIZE: 37.4" H x 27" W

COLORS: Standard white, grey or black. Custom options available.

FRAME Metal, Stainless Steel (Upgrade)

SHIPPING: Crate: 31" x 49" x 41", 210 lbs/95.25kg

- Retractable Window
- Multiple heights
- Perfectly counter balanced
- Easily raised and lowered
- 1.0mm LE base
- .50mm LE lead acrylic window
- 2 high-quality hospital grade locking casters
- Complete with bar to hold controls

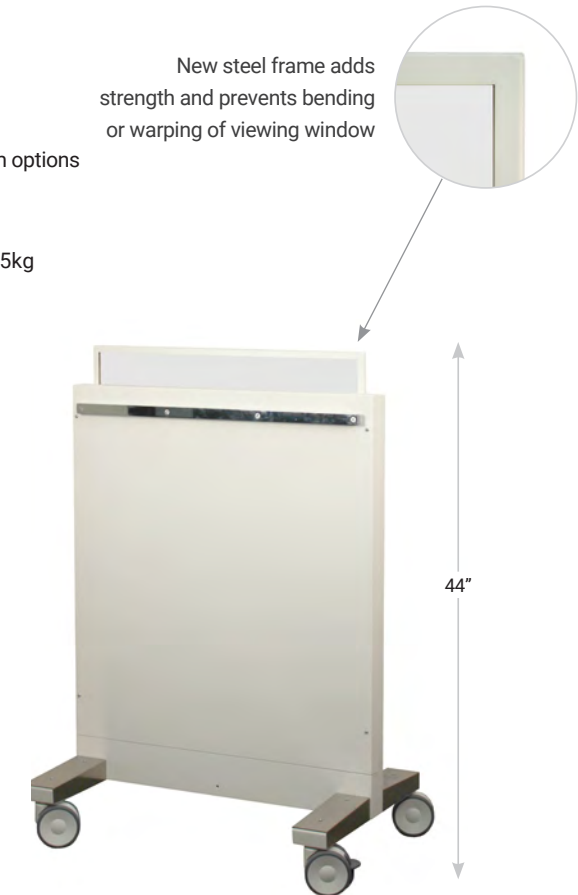

STANDARD BARRIERS

Available in a variety of heights, widths, and window configurations, INFAB barriers are fully customizable, to any specifications. Custom colors, logos and 100% stainless steel options are available. Full head-to-toe protection with our exclusive base curtain included on every barrier. Your choice of 2.0mm LE lead glass or .50mm LE acrylic window. All bases are 1.50mm LE.



683492

LARGE WINDOW MOBILE BARRIER

SIZE: 80¼" H x 40½" W X 25" D
WINDOW: 72" H x 36" W
GLASS: Lead or Acrylic (-AC)
SHIPPING Crate: 30" x 78" x 48"
 480lbs / 217.72 kg

683476

X-TALL MOBILE BARRIER

SIZE: 78¼" H x 40½" W X 25" D
WINDOW: 60" H x 36" W
GLASS: Lead or Acrylic (-AC)
SHIPPING: Crate: 30" x 78" x 48"
 450lbs / 204.12 kg

683488

X-WIDE MOBILE BARRIER

SIZE: 74½" H x 76½" W X 25" D
WINDOW: 36" H x 72" W
GLASS: Lead or Acrylic (-AC)
SHIPPING: Crate: 32" x 85" x 85"
 600lbs / 272.16 kg

683473

MID-TALL MOBILE BARRIER

SIZE: 74½" H x 34½" W X 25" D
WINDOW: 60" H x 30" W
GLASS: Lead or Acrylic (-AC)
SHIPPING: Crate: 73" x 30" x 43"
 380lbs/172.36kg

BARRIER FEATURES

- All INFAB Barriers include four hospital grade casters, 2 with locking brakes.
- Fully enclosed glass with our exclusive concussion panels to protect the lead glass.
- Easy-clean Sintra plastic base and high quality powder coated steel frames.



683482

**WIDE
MOBILE BARRIER**

SIZE: 72" H x 52½" W X 25" D
WINDOW: 36" H x 48" W
GLASS: Lead or Acrylic (-AC)
SHIPPING: Crate: 30" x 72" x 60"
 480 lbs / 217.72 kg

683465

**SMALL WINDOW
MOBILE BARRIER**

SIZE: 72¼" H x 52½" W X 25" D
WINDOW: 12" H x 12" W
GLASS: Lead or Acrylic (-AC)
SHIPPING: Crate: 30" x 72" x 60"
 380 lbs / 217.72 kg

683468

**MEDIUM WINDOW
MOBILE BARRIER**

SIZE: 74" H x 52½" W X 25" D
WINDOW: 12" H x 24" W
GLASS: Lead or Acrylic (-AC)
SHIPPING: Crate: 73" x 30" x 57"
 410 lbs / 185.97 kg

683460

**STANDARD
MOBILE BARRIER**

SIZE: 72" H x 34½" W X 25" D
WINDOW: 24" H x 30" W
GLASS: Lead or Acrylic (-AC)
SHIPPING: Crate: 30" x 72" x 42"
 335 lbs / 151.95 kg

683484

**REGULAR
MOBILE BARRIER**

SIZE: 64½" H x 40½" W X 25" D
WINDOW: 24" H x 36" W
GLASS: Lead or Acrylic (-AC)
SHIPPING: Crate: 30" x 65" x 48"
 430 lbs / 195.04 kg

683458

**"SHORTY"
MOBILE BARRIER**

SIZE: 45" H x 34½" W X 25" D
WINDOW: 24" H x 30" W
GLASS: Lead or Acrylic (-AC)
SHIPPING: Crate: 45" x 30" x 42"
 220 lbs / 99.79 kg

683495 ADJUSTABLE HEIGHT WRAPAROUND MOBILE BARRIER

An adjustable height, partial wraparound mobile barrier, designed for maximum protection. Easy to adjust and maneuver. Includes protection all the way to the floor.

- SIZE:** 42"-55" H x 36³/₄" W; Tower 25" W
 Height adjusts from 42" to 55"
 Inside 20¹/₂" W x 17" D
- PROTECTION:** .50mm LE
- COLORS:** All fabric options
- SHIPPING:** Crate: 30" x 42" x 44", 210 lbs / 95.25 kg

- Powder coated steel frame
- 2 high-quality hospital grade locking casters
- Shipping worldwide by ground, air or sea freight



Easy to adjust height





REV-MHAS REVOLUTION MOBILE HANGING ACRYLIC SHIELD

Fully adjustable mobile shield that can be altered to user's preference. This product provides the benefits of an overhead suspension barrier with the mobility to fit into exam rooms of any size. The acrylic barrier can be raised, lowered, and rotated 360° in both vertical and horizontal planes to fit snug against the torso of the patient.

KEY FEATURES:

- Mobile unit with superior stability.
- Gives user full control of shield placement.
- Pivot ball allows for 360° motion.
- Durable 0.50mm acrylic shield.
- Small footprint, does not interfere with physician's position at the table.

DIMENSIONS:	79" H x 37" W x 25" D
WINDOW SIZE:	24" H x 30" W
PROTECTION:	Lead acrylic window .50mm LE
COLORS:	Standard off-white powder coated. Other colors available.
FRAME	Powder Coated Steel
WHEELS:	4 swivel hospital grade casters (2 with brakes)



Full 360° Pivot ball for precise positioning

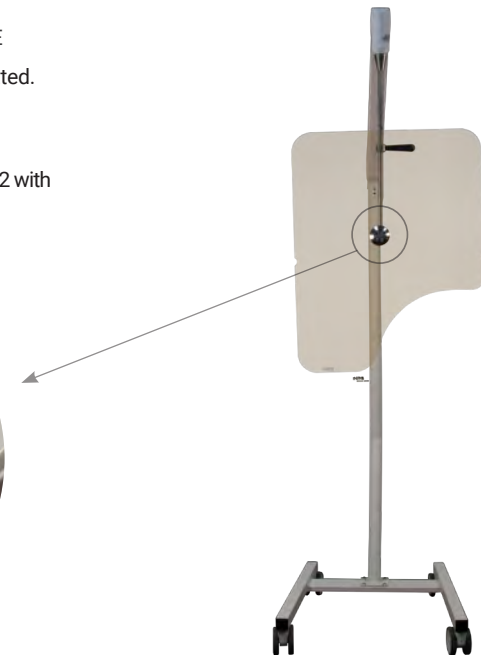

Front profile

APRON RACKS

INFAB Apron Racks are purpose-built pieces of hospital equipment, designed to last as long as the facility they are being used in.

OPTIONS

- Mobile
- Wall-Mounted
- Single Apron
- Multi-Apron
- Deluxe
- Economy
- Custom Colors

HOSPITAL GRADE MATERIALS

- Cold-rolled metal or optional stainless steel frames
- Hospital grade casters, two with locking brakes, for easy mobility and positive placement when parked.

THOUGHTFUL DESIGN

- Easy to use
- Space-efficient
- Plentiful storage
- Easy on/off apron convenience



**REV-MRK-10****REVOLUTION 10 ARM MOBILE APRON RACK**

ASSEMBLED SIZE: 59 3/4" H x 43" W X 31" D

COLORS: White, Custom Options

SHIPPING: Box 1: 16" x 58" x 9", 52 lbs / 23.59 kg
Box 2: 34" x 45" x 14", 58 lbs / 26.31 kg

- Holds up to 10 vest and skirt aprons
- Vest and skirts hang on a single arm
- Handy storage area on base
- Heavy duty hangers that swivel on a sealed ball bearing for years of trouble-free use
- New circular tube design with sleek look



683435

10 HANGER MOBILE APRON VALET

ASSEMBLED SIZE: 58" H x 26½" W X 25" D

COLORS: White/Chrome, Custom Options

SHIPPING: Box 1: 55" x 7" x 7", 25 lbs / 11.34 kg
Box 2: 16" x 32" x 14", 34 lbs / 15.42 kg

- Space saving; providing major storage while taking up minimum space.
- Steel construction with baked enamel finish.
- 2 high-quality hospital grade locking casters
- 10 Deluxe Custom Apron Hangers (683450) included



683438

20 HANGER MOBILE APRON VALET

ASSEMBLED SIZE: 58" H x 48½" W X 25" D

COLORS: White/Chrome, Custom Options

SHIPPING: Box 1: 55" x 7" x 7", 32 lbs / 14.51 kg
Box 2: 16" x 32" x 14", 43 lbs / 19.50 kg

- Space saving; providing major storage while taking up minimum space.
- Steel construction with baked enamel finish.
- 2 high-quality hospital grade locking casters
- 20 Deluxe Custom Apron Hangers included
- Optional: full circle loop hangers (-H)



683419

MINI MOBILE APRON RACK WITH HANGERS

ASSEMBLED SIZE: 78" H x 27" W X 25" D

COLORS: White, Custom Options

SHIPPING: Box: 29" x 49" x 8", 59 lbs / 26.76 kg

- Six apron hangers included
- Heavy gauge cold rolled steel
- Powder coated
- Attractive, durable, long lasting finish
- 2 high-quality hospital grade locking casters
- Holds up to six protection aprons, a pair of lead gloves and two pairs of radiation protection glasses

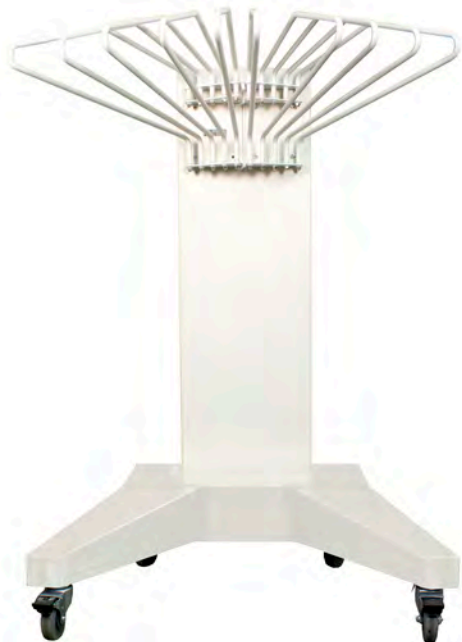
**683407**

DELUXE MOBILE APRON RACK

ASSEMBLED SIZE: 53" H x 39" W X 26" D

COLORS: White, Custom Options

SHIPPING: Box 1: 16" x 32" x 14", 25 lbs / 11.34 kg
Box 2: 40" x 29" x 12", 55 lbs / 24.95 kg
Box 3: 58" x 17" x 9", 52 lbs / 23.59 kg

- Super heavy-duty
- 2 high-quality hospital grade locking casters
- Stores up to ten protection aprons
- Optional vest and skirt adapter (Part Number 683000)
- Holds up to 200 lbs. of aprons

**683426**

5 ARM BUDGET SAVER MOBILE APRON RACK

ASSEMBLED SIZE: 58" H x 26" W X 30" D

COLORS: White, Custom Options

SHIPPING: Box 1: 51" x 7" x 7", 31 lbs / 14.06 kg
Box 2: 16" x 32" x 14", 34 lbs / 15.42 kg
Box 3: 16" x 41" x 7", 21 lbs / 9.53 kg
Box 4: 26" x 21" x 2", 12 lbs / 5.44 kg

- Economically priced
- Heavy gauge steel
- Powder coated
- 2 high-quality hospital grade locking casters
- Stores up to 5 protection aprons
- Convenient additional storage on base
- Optional vest and skirt adapter (Part Number 683000)

**683427**

10 ARM BUDGET SAVER MOBILE APRON RACK

ASSEMBLED SIZE: 58" H x 44½" W x 30" D

COLORS: White, Custom Options

SHIPPING: Box 1: 51" x 7" x 7", 36 lbs / 16.33 kg
Box 2: 16" x 32" x 13", 34 lbs / 15.42 kg
Box 3: 58" x 16" x 9", 40 lbs / 18.14 kg
Box 4: 22" x 44" x 2", 21 lbs / 9.53 kg

- Economically priced
- Heavy gauge steel
- Powder coated
- 2 high-quality hospital grade locking casters
- Stores up to 10 protection aprons
- Convenient additional storage on base
- Optional vest and skirt adapter (Part Number 683000)

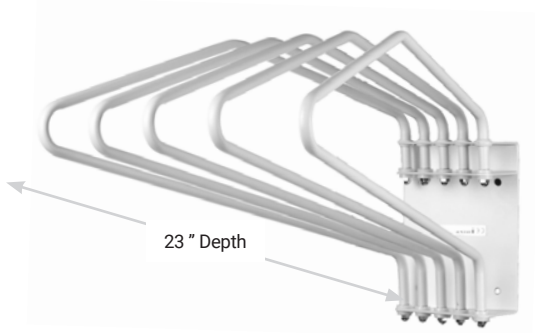

683101

5 Arm Left Folding Apron Rack

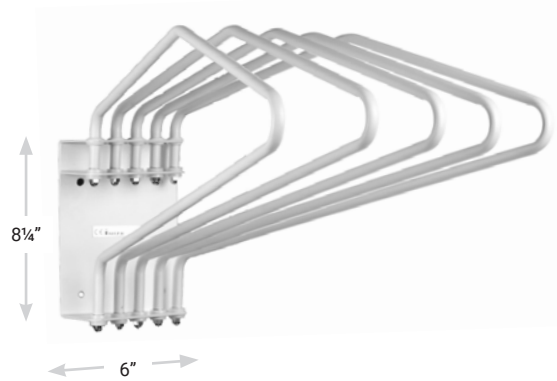

683100

5 Arm Right folding Apron Rack

WALL-MOUNTED 5 ARM APRON RACK

ASSEMBLED SIZE: 8 1/4" H x 6" W X 23" D

COLORS: White, Custom Options

- Stores up to 5 aprons
- Swings out easily for immediate access to aprons
- Heavy duty
- Power coated steel mounting bracket and storage arms
- Arms with nylon bushings
- Racks fold flush to wall
- Can be mounted side by side
- Optional vest and skirt adapter (Part Number 683000)



683000
Vest and Skirt Rack Adapter

- Skirt rack adapter easily mounts to rack with included tool. Skirt hanging adapter provides convenient storage for vest & skirt aprons.

SHIPPING

683100 5 Arm Folding Right Hand Folding

Box 1: 10 lbs (12" x 30" x 6")

683101 5 Arm Folding Left Hand Folding

Box 1: 10 lbs (12" x 30" x 6")

683415 WALL-MOUNTED WALL TOWER RACK**ASSEMBLED SIZE:** 48" H x 13 ¾" W X 27" D (w/racks)**COLORS:** White, Custom Options

- Includes right and left 5 arm apron racks
- Heavy duty
- Handles toughest hospital environments
- Heavy gauge steel
- Powder coated
- Scratch resistant
- Easy to install
- Hardware provided
- Requires only minimal space
- 13.75" wide x 48" tall

SHIPPING

683115 Weak Wall Support

683415 Rack/Tower W/ R.H. & L.H. Racks

Box 1: 10 lbs (12" x 30" x 6")

Box 1: 10 lbs (12" x 30" x 6")



683415
Wall Tower Rack with right and left
hand racks

683115
Weak Wall Support

683429 WALL MOUNTED RACK

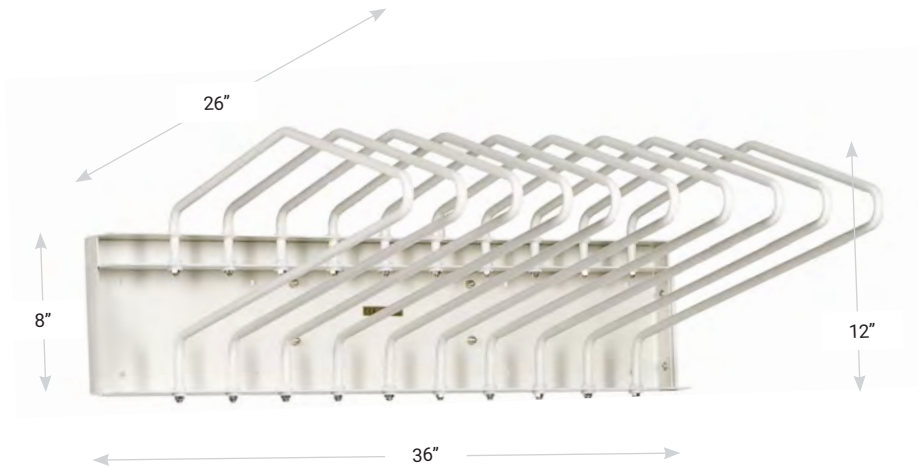

ASSEMBLED SIZE: 12" H x 36" W X 26" D

COLORS: White, Custom Options

- Heavy gauge steel
- 200 lbs. capacity
- Powder coated
- Scratch resistant
- Easy to install
- Requires only minimal space
- Stores up to 10 aprons
- Optional vest and skirt adapter (Part Number 683000)

683429 SHIPPING

Box 1: 40 lbs (16" x 58" x 9")

683430 APRON AND GLOVE COMBINATION RACK

ASSEMBLED SIZE: 17" H x 28³/₄" W (9¹/₂" Baseplate)

COLORS: White, Custom Options

- Rounded corners to prevent accidental apron tears or skin punctures
- Quick, convenient storage
- Stores 1 apron and 1 pair of lead gloves
- Sturdy & compact
- Mounts quickly and easily
- Heavy gauge steel mounting plate
- Half inch outside diameter tubing
- Electro static powder coated

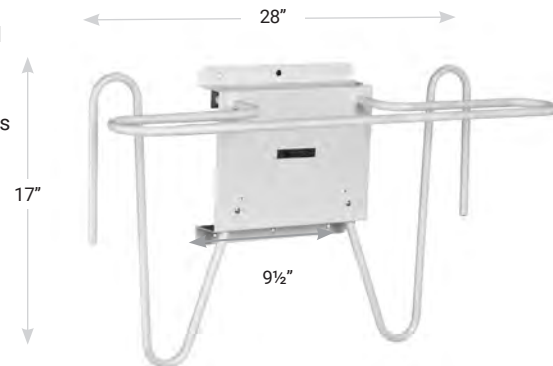

683430 SHIPPING

Box 1: 9 lbs. (19" x 30" x 11")

683420 APRON AND GLOVE STORAGE RACK

ASSEMBLED SIZE: 25" H x 28" W x 6" D

COLORS: White, Custom Options

- Quick, convenient storage
- Sturdy
- Compact
- Mounts quickly and easily
- Heavy gauge steel mounting plate
- Half inch outside diameter tubing
- Electro static powder coated
- Great for dental aprons

683420 SHIPPING

Box 1: 15 lbs (26" x 31" x 8")



683102 PROTECTIVE ACCESSORIES RACK



ASSEMBLED SIZE: 21" H x 18½" x 5" D
COLORS: White, Custom Options

- Storage unit for two or more aprons, a pair of glasses and a pair of lead gloves
- Mounts quickly and easily
- 18" wide
- Extends a mere 4.5" from the wall
- Contains no sharp edges
- Perfectly suited to small areas
- Powder coated heavy steel construction

683102 SHIPPING
 Box 1: 8 lbs (19" x 23" x 8")

683424 SINGLE BAR APRON RACK



ASSEMBLED SIZE: 6" H x 18 ½" W x 3" D
COLORS: White, Custom Options

- Storage unit for one apron
- Mounts quickly and easily
- Contains no sharp edges
- Perfectly suited to small areas
- Powder coated heavy steel construction

683102 SHIPPING
 Box 1: 3 lbs (24" x 4" x 8")

683452 LOCKER SIZE HANGER



SIZE: 6" H x 14 ½" W
COLORS: White, Custom Options

- Securely hold a radiation protection apron
- Constructed from heavy gauge steel tube
- Designed to fit in personal locker
- Powder coated



Optional hook (-H)

683450 DELUXE CUSTOM HANGER



SIZE: 7½" x 22½"
COLORS: Chrome, Custom Options

- Securely hold a radiation protection apron
- Constructed from heavy gauge steel tube
- Chrome plated
- Available in a pack of 5 hangers
- Part Number 683451



Optional hook (-H)

683412 TWO PEG WALL MOUNTED RACK



683412 Two Peg Wall Mounted Rack
683412-LS Two Peg Wall Mounted Rack with Locking System

ASSEMBLED SIZE: 9" H x 15 1/4" W x 7 1/4" D
COLORS: White, Custom Options
SHIPPING: Box: 11" x 18" x 9", 6 lbs / 2.72 kg

683410 SIX PEG WALL MOUNTED RACK



683410 Six Peg Wall Mounted Rack
683410-LS Six Peg Wall Mounted Rack with Locking System

ASSEMBLED SIZE: 9" H x 34 1/2" W x 7 1/4" D
COLORS: White, Custom Options
SHIPPING: Box: 11" x 37" x 9", 16 lbs / 7.26 kg

683411 EIGHT PEG WALL MOUNTED RACK



683411 Eight Peg Wall Mounted Rack
683411-LS Eight Peg Wall Mounted Rack with Locking System

ASSEMBLED SIZE: 9" H x 46 1/2" W x 7 1/4" D
COLORS: White, Custom Options
SHIPPING: Box: 13" x 47" x 10", 21 lbs / 9.53 kg

LS LOCKING SYSTEM



- Available in 2 peg, 6 peg, or 8 peg configurations
- Inexpensive and very effective
- Heavy gauge steel plate
- Electrostatic powder coated
- Tilted storage bars so aprons wont slip off
- Requires minimal space
- Includes lock

REVOLUTION MOBILE APRON LOCKERS

Features digital passcode locks with keypad
Set up to 3 administrative and user passcodes
Battery operated lock with backup battery and
emergency power supply



REV-LOCKER-20



Hangers Included



Passcode Lock with Keypad



REV-LOCKER-5

**REVOLUTION 5 HANGER
MOBILE APRON LOCKER**

ASSEMBLED SIZE: 65" H x 16" W x 26.5" D

COLORS: White, Grey, or Black
Custom colors available.
Ships in standard white unless specified.

SHIPPING: Crate: 29" x 20" x 70", 170 lbs / 77.11 kg

Includes 5 hangers
Secure up to 5 aprons



REV-LOCKER-10

**REVOLUTION 10 HANGER
MOBILE APRON LOCKER**

ASSEMBLED SIZE: 65" H x 32" W X 26.5" D

COLORS: White, Grey, or Black
Custom colors available.
Ships in standard white unless specified.

SHIPPING: Crate: 29" x 36" x 70", 205 lbs / 93 kg

Includes 10 hangers
Secure up to 10 aprons



REV-LOCKER-20

**REVOLUTION 20 HANGER
MOBILE APRON LOCKER**

ASSEMBLED SIZE: 65" H x 48" W X 26.5" D

COLORS: White, Grey, or Black
Custom colors available.
Ships in standard white unless specified.

SHIPPING: Pallet: 29" x 52" x 70", 230 lbs / 148.33 kg

Includes 20 hangers
Secure up to 20 aprons

CURTAINS

INFAB's line of radiation protection curtains provide the highest level of quality while offering full customization. These high quality curtains are available with a heavy-duty track that is built to your specifications. Our curtain tracks are available either straight or curved to ensure you get the right fit for your room. INFAB's radiation protection curtains are available in multiple levels of protection as well as any size, colors and fabrics that we offer.

Custom Sizes

Our radiation protection curtains are custom manufactured to whatever specifications you need. We will work with you to make sure that your curtains arrive exactly how you want them, and as quickly as possible.

Custom Tracks

INFAB knows not every room is built the same. If you need a curved track for your INFAB radiation protection curtains, we are happy to build it for you at your exact specifications. INFAB will gladly work with you to create the exact curtain and track you need to make your room perfect and functional.

Contact us with your configuration for an instant quote.



LEAD CURTAIN



Our lead curtains include one grommet hole with a "S" hook every six inches.

- COLORS:** Classic Nylon Colors
- CORE:** Lightweight Lead, KIARMOR Lead-Free
- PROTECTION:** .25mm LE, .35mm LE, .50mm LE, .75mm LE, 1.0mm LE
- SIZE:** Per square foot

- 683650** .25mm LE curtain with grommets (per sq. ft.)
- 683655** .35mm LE curtain with grommets (per sq. ft.)
- 683660** .50mm LE curtain with grommets (per sq. ft.)
- 683670** .75mm LE curtain with grommets (per sq. ft.)
- 683675** 1.0mm LE curtain with grommets (per sq. ft.)

683680 STRAIGHT TRACK FOR CURTAIN

Mill finish 6063-T5 extruded aluminum 1-3/4" wide x 2" high, .080 thick.
Priced per linear foot.

- INCLUDES:**
- 1 Straight Track
 - 2 End Stops
 - 1 Single Carrier for each grommet hole on curtain

- OPTIONS:**
- Clamp Hanger
 - Ceiling Splice
 - Trim Chain

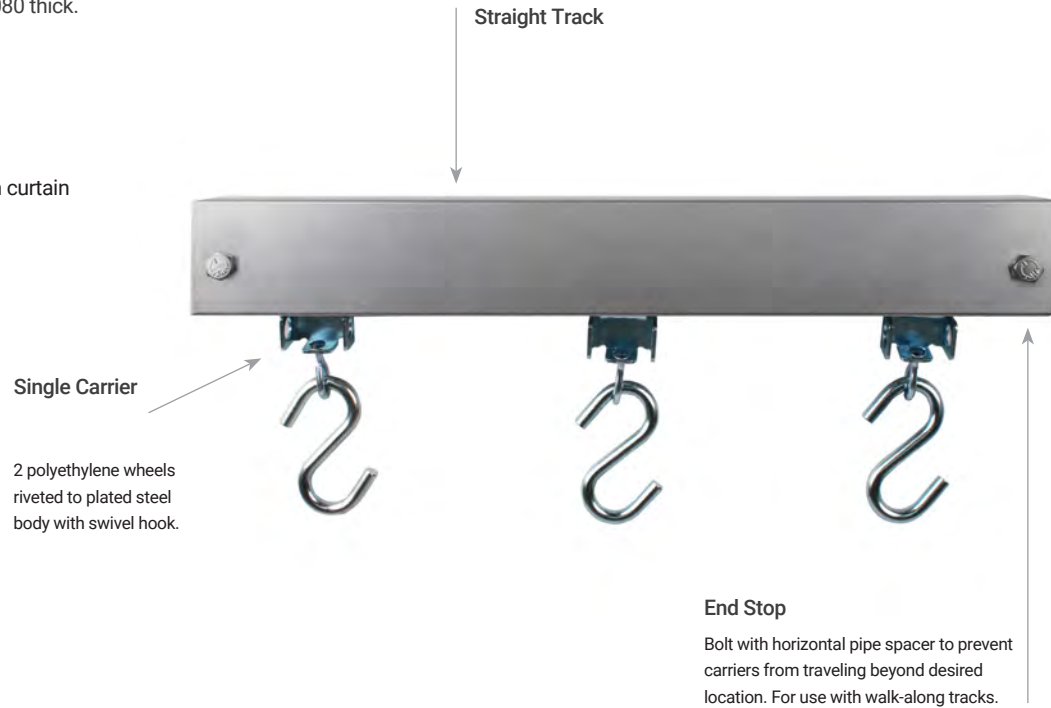

Single Carrier

2 polyethylene wheels riveted to plated steel body with swivel hook.

End Stop

Bolt with horizontal pipe spacer to prevent carriers from traveling beyond desired location. For use with walk-along tracks.

OPTIONS:

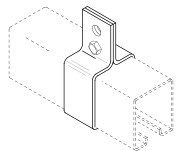

Clamp Hanger

Formed steel brackets clamp to track. Adjusts to any position. Suspend track with welded chain or wire rope. 1 pair pictured.

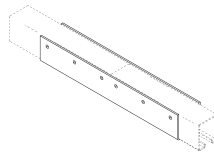

Ceiling Splice

To align and lock track sections together on ceiling mounted tracks. 1 pair pictured.

Note: Cannot be used with No. 132 Overlap Master or No. 10 Pivot Device due to interference with the wheels.



Trim Chain

3 links No.10 single jack chain added to carriers to provide 3" of curtain height adjustment

683690 CURVED TRACK FOR CURTAIN

Mill finish 6063-T5 extruded aluminum 5/8" wide x 1-11/16" high, 0094" thick.
For curved track applications only. **Each piece requires custom quoting.**



Curved Track

Single Carrier

2 polyethylene wheels riveted to plated steel body with swivel hook.

End Stop

Bolt with horizontal pipe spacer to prevent carriers from traveling beyond desired location. For use with walk-along tracks.



Trim Chain

3 links No.10 single jack chain added to carriers to provide 3" of curtain height adjustment

OPTIONS:

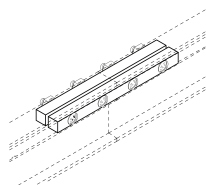

Splice

Steel plates align and lock track together. 1 pair pictured.

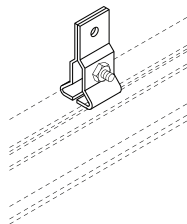

Clamp Hanger

Formed steel brackets clamp to track. Adjusts to any position. Suspend track with welded chain or wire rope. 1 pair pictured.

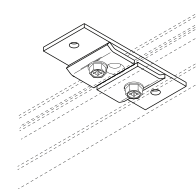

Ceiling Hanger

Steel plate mounts flush to ceiling. Track clamps to bracket with offset clips.

Lead Curtains

These scatter shields are attached to the table to protect both the operator and the patient from harmful radiation.

Easy Setup & Installation

Easily slides onto most tables with side rails and quickly locks in to place with an adjustable knob.

077036 SINGLE PANEL SCATTER SHIELD

The below-table protection screen is attached to the table to protect the operator's lower body from radiation. The upper part of the screen (removable) protects against scatter radiation from the patient's body. The lower part protects the operator's lower body against the radiation from the tube source.

UPPER SCREEN

- .50mm LE with stiff support
- 11" H x 26" W
- Hooks into mobile arm that can be easily removed

LOWER SCREEN

- .50mm LE made up of 4 strips
- 30" L x 26" W

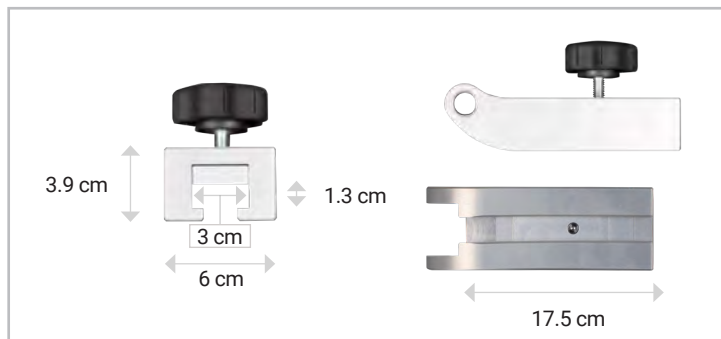
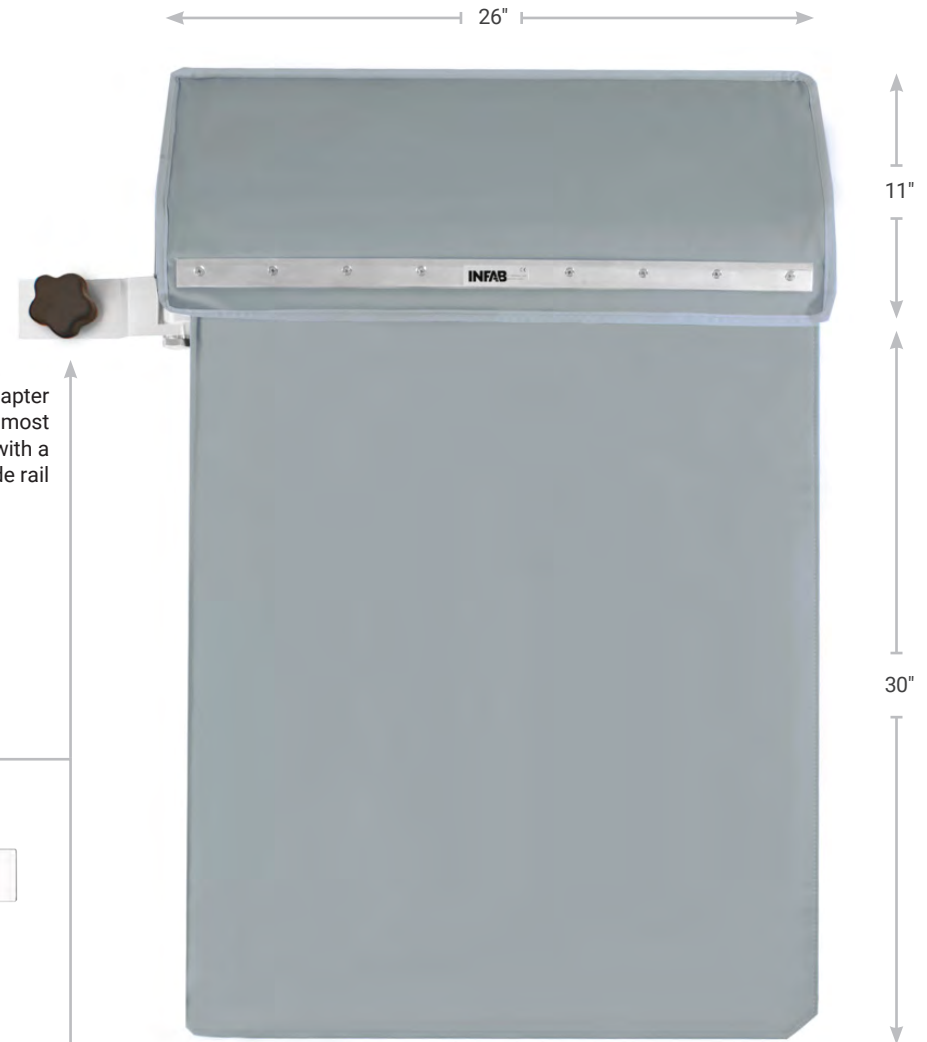

077035 MULTIPLE PANEL SCATTER SHIELD

The below-table protection screens are attached to the table to protect the operator's lower body from radiation. The upper part of the screen (removable) protects against scatter radiation from the patient's body. The lower part protects the operator's lower body against the radiation from the tube source.

UPPER SCREEN

- .50mm LE with stiff support
- 11" H x 26" W
- Hooks into mobile arm that can be easily removed

LOWER SCREEN

- .50mm LE made up of 4 strips
- 30" L x 26" W

ADDITIONAL STRIP (INCLUDED)

- Applied with addition of intermediate joint
- 30" L x 10" W

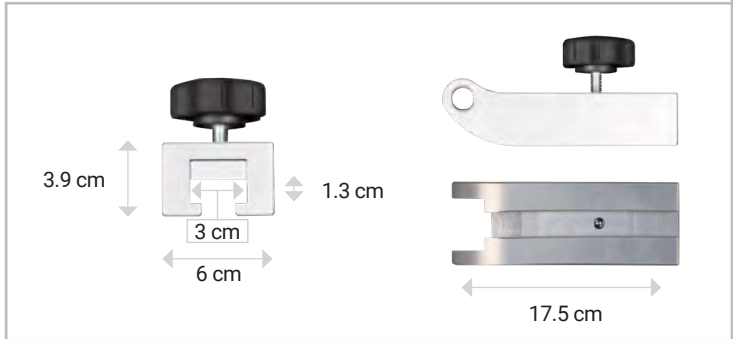
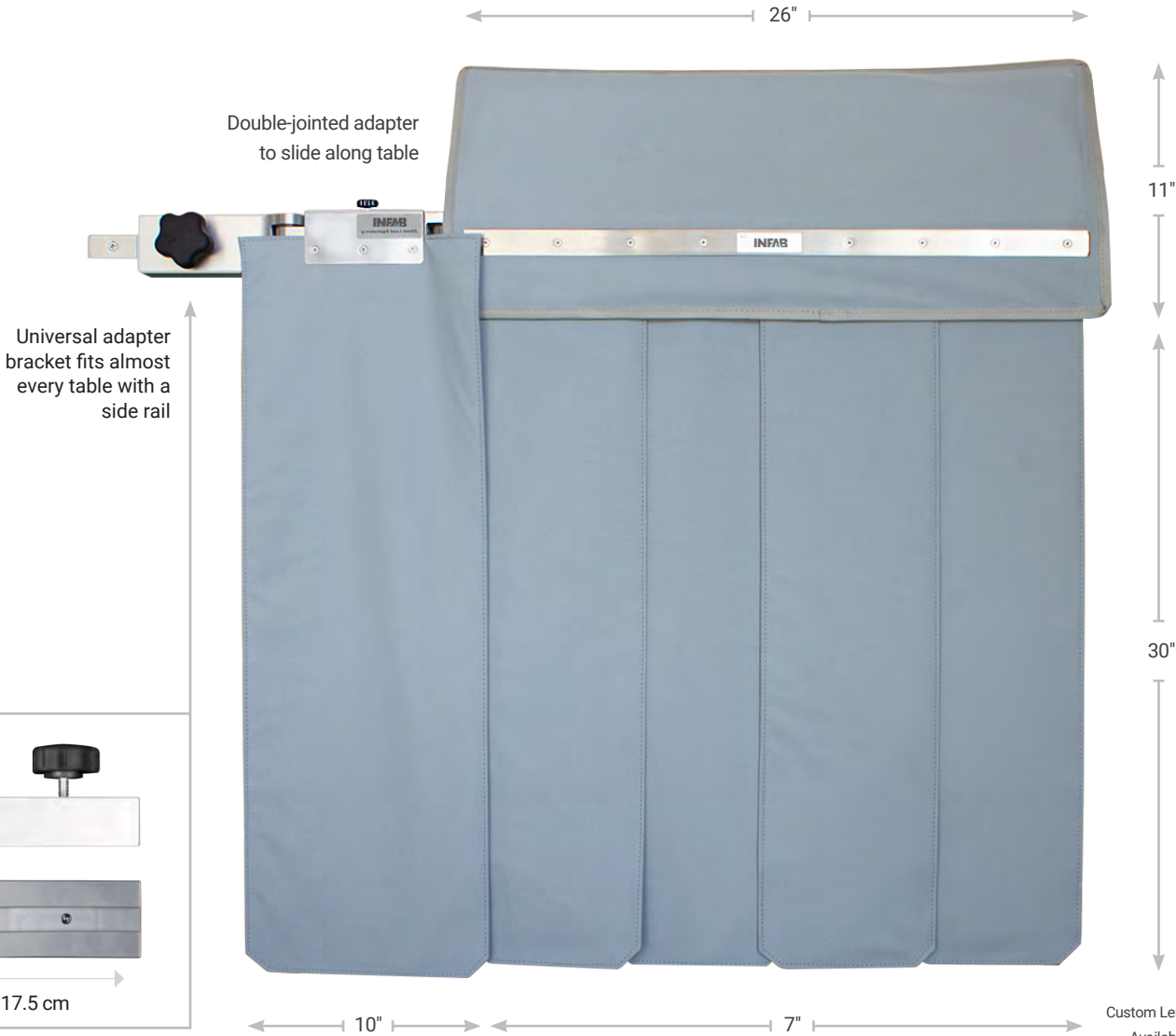

Custom Lengths Available

990007 SADDLE SHIELD RADIATION PROTECTION CURTAINS

Saddle Shield Radiation Protection Curtains designed to help protect the body from being exposed to radiation.

KEY FEATURES

- .50mm LE
- Significantly reduces scatter radiation
- Overlapping split front panels
- No special hardware or modifications to imaging equipment required
- Available in any of our fabric colors
- Provide exact dimensions and drawing to fit your specific size table

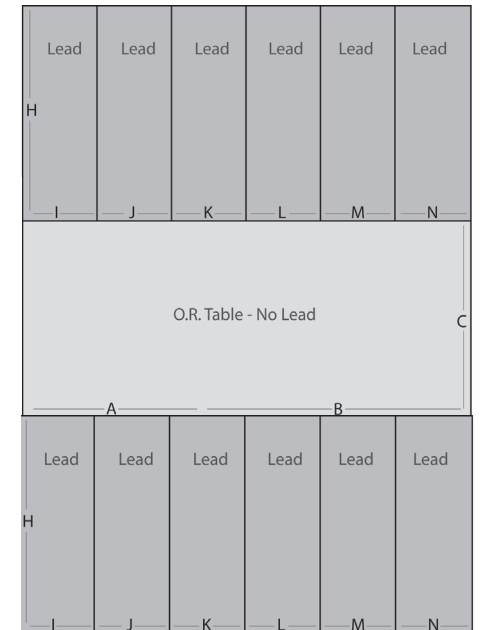
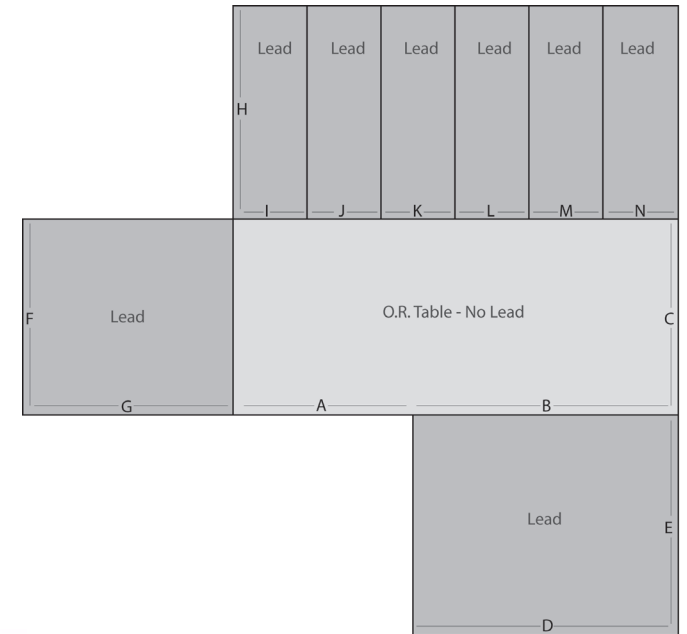

683400 PATIENT PROTECTION SET

- INCLUDES:** Storage rack with 4 aprons (Toddler, Child, Average, Large)
- COLORS:** Classic Nylon Colors
- CORE:** Lightweight Lead, KIARMOR Lead-Free
- PROTECTION:** .25mm LE, .35mm LE, .50mm LE
- SIZES:** Toddler, Child, Average Adult, Large Adult



683401
9" H x 11.5" W
Toddler Apron

683402
13" H x 13" W
Child's Apron

683403
14" H x 17.5" W
Average Adult Apron

683404
17" H x 21" W
Large Adult Apron



HALF APRON

HSV

Hook and Loop Closure Half Apron

- HSV-S1** 12" x 24" Half apron with hook and loop closure
- HSV-M1** 18" x 24" Half apron with hook and loop closure
- HSV-L1** 24" x 24" Half apron with hook and loop closure



Standard hook and loop closure

ASB

Buckle Closure Half Apron

- ASB-S1** 12" x 24" Half apron with buckle closure
- ASB-M1** 18" x 24" Half apron with buckle closure
- ASB-L1** 24" x 24" Half apron with buckle closure



PP-ES DISPOSABLE EYE SHIELDS



- Minimum 40% dose reduction
- Box of 50
- Barium sulfate shields are non-latex and 100% disposable

PP-TS DISPOSABLE THYROID SHIELD

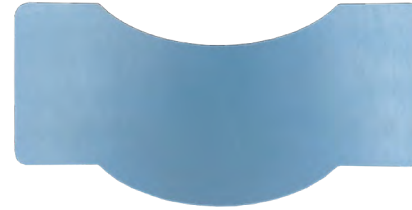

- Minimum 60% dose reduction
- Box of 50
- Barium sulfate shields are non-latex and 100% disposable

684120 OVARIAN SHIELDS



- Set of the three (Infant, Youth and Adult)
- Designed especially for ovarian procedures
- 1.0mm LE
- Easy to use and explain to your patient
- Available in our Classic Nylon Colors
- Durable
- Easily wipes clean

PGS GONAD SHIELDS



- Set of three or available individually: (Infant, Youth and Adult)
- 3/4" tie strap
- Easy fastening around the waist
- .50mm LE
- Available in our Classic Nylon Colors

GND TRIANGULAR GONAD SHIELDS



- Set of three (Infant, Youth and Adult)
- One inch tie strap
- Easy fastening around the waist
- .50 mm Pb equivalent

PTD PATIENT TRANSFER DEVICE

- Radiolucent plastic
- 18" or 22" wide models
- Also available with storage rack
- Large hand holds
- One inch wide wrist straps
- Anti-static
- Thin
- Board slides easily from surface to surface
- Tested up to 300 lbs.

MODELS: PTD-18, PTD-22
COLORS: White
SHIPPING: PTD-18
 Box: 73" x 23" x 1", 11 lbs / 4.99 kg
 PTD-22
 Box: 73" x 23" x 1", 13 lbs / 5.90 kg



FEATURE YOUR COMPANY LOGO

Upcharge applies



683399 PATIENT TRANSFER RACK

Wall mounted rack for PTD storage

SIZE 9" H X 15" ¼ W x 6 ¾" D

FDA

Establishment Registration & Device Listing:
 INFAB, LLC.
 1040 Avenida Acaso
 Camarillo, CA 93012
 Registration Number: 2024351

Date of Registration Status: 2017
 Owner/Operator:
 INFAB, LLC.
 1040 Avenida Acaso
 Camarillo, CA 93012

Owner/Operator Number: 2024351
 1040 Avenida Acaso
 Camarillo, CA 93012
 Phone: 805-987-5255

FDA Certificate

Device Classification Name:	Shield, protective, personnel
510(k) Number	K896289
Device Name	RADIATION PROTECTION APRON
Applicant	INFAB, LLC. 1040 Avenida Acaso Camarillo, CA 93012
Regulation Number	892.6500
Classification Product Code	KPY
Date Received	10/31/1989
Decision Date	12/14/1989
Decision	Substantially equivalent (SE)
Classification Advisory Committee	Radiology
Review Advisory Committee	Radiology
Statement/Summary/Purged Status	Purged, no summary or statement
Type	Traditional
Reviewed by Third Party	No

510(k) Premarket Notification

Proprietary Name	Non leaded apron
Classification Name	Apron, non leaded
Product Code	EAJ
Device Class	1
Regulation Number	892.6500
Medical Specialty	Radiology
Registered Establishment Name	INFAB, LLC.
Registered Establishment Number	2024351
Owner/Operator	INFAB, LLC.
Owner/Operator Number	2024351
Review Advisory Committee	Radiology
Establishment Operations:	Manufacturer



1. **PRICING, DELIVERY AND PAYMENT.** The prices for Product delivered under this Order do not include customs charges or duties, or sales, use, excise or similar taxes, or special packaging, or transportation, rigging, drayage, insurance charges and other costs associated with the delivery of Product to the destinations specified by the Customer unless specifically set out on the invoice as individual line items. Therefore Customer will pay directly to Seller ("Seller"), in addition to the prices specified in this Order, any amount set forth on Seller's invoices for customs charges, duties and/or taxes (or provide applicable tax exemption certificates acceptable to the taxing authorities) and special packaging costs, and shall pay directly to the involved carrier(s) all such delivery related costs. All licenses or certificates required for import or export of the Product shall be the responsibility of and obtained at the cost of Customer. Seller's terms are cash upon delivery, unless otherwise set forth in a distribution or reseller agreement. If payment is by credit card, an additional fee will apply. If credit terms are approved by Seller, Customer shall pay all invoices net thirty (30) days after date of shipment. If payment is not made when due, Customer shall be assessed a late charge equal to one and one-half percent (1-1/2%) of the past due balance for each month or partial month following the due date. Additionally, at seller's discretion, all discounts shall be removed and any amounts due shall be the current list price of such items, regardless of any other agreement or discount offered. All deliveries shall be made F.O.B. common carrier, Seller's plant. Title and risk of loss or damage will transfer from Seller to Customer upon delivery of goods at the F.O.B. point. Customer shall notify Seller, in writing, within one (1) calendar day after delivery, of any claimed shortages, damage or of rejection of the delivery. Sufficient detail to establish grounds shall be included in any rejection.

2. **PRODUCT SAMPLES.** Product samples will be provided to licensed distributors of Seller's product. Upon termination of a distribution arrangement, distributor shall return to Seller, at distributor's expense, all samples previously provided to distributor by Seller in resalable as new condition. For any goods not returned in accordance with the above, Distributor will be invoiced for sample product at the same discount established for distributor for production goods. If invoice is not paid within 10 days of receipt, all discounts will be canceled and prices for samples will revert to full List Price.

3. **SECURITY INTEREST.** Seller reserves, until full payment is received, a Purchase Money Security Interest in each Product Unit and the proceeds of any sale thereof. A copy of this Order may be filed as a Financing Statement with the appropriate state authorities to perfect the security interest of Seller.

4. **CANCELLATION OF PRODUCT.** Customer hereby acknowledges and agrees that all Product is custom manufactured for each individual Customer and

once production has commenced there can be no cancellation of orders.

5. **TERMINATION.** This Order may be terminated by either party at any time: (a) if the other party has breached any material provision contained in this Order and has not cured the breach within thirty (30) days of receipt of written notice of the breach; or (b) if the other party petitions for relief under the Bankruptcy Act, if a receiver is appointed to conduct its business, if its makes an assignment for the benefit of creditors or if an involuntary bankruptcy petition is brought against it and has not been discharged within 30 days of date brought. Seller termination of this Order shall be without prejudice to any other remedies Seller may have. In the event Seller terminates this Order pursuant to Article 4, in addition to any other remedies available to Seller, Customer shall be obligated to pay for all Product shipped and shall accept delivery of and pay for all Product on order as of the date of termination. Customer's obligation to pay all charges accrued as of the termination hereof shall survive such termination.

6. **GENERAL PROVISIONS.** These terms and conditions shall supersede all terms and conditions printed or implied on any purchase order issued by Customer. No other terms or conditions shall be binding upon Customer or Seller unless said terms and conditions are specifically accepted in writing by Customer and Seller. The failure of Customer or Seller to enforce at any time or for any period of time any of the provisions of this Order shall not constitute a waiver of such provisions. Seller shall not be liable for delays or failure to ship for causes beyond Seller's control, affecting it or its suppliers, including, in part: natural disasters; war; Customer's conduct; labor unrest; riot; governmental interference; unavailability or shortage of labor, materials, fuel or power through customary means at normal rates; failure or destruction of plant or equipment arising from any cause whatsoever; or failure of transportation. If any provision of this Order should be determined to be unenforceable or illegal, it shall be deemed severable from the other provisions, which shall remain valid and enforceable. The validity, performance and construction of this Order shall be governed by the laws of the state of California. Customer agrees to accept venue in, and accept the exclusive jurisdiction of, the courts sitting in the state of California. Any disputes arising out of the performance of this Order shall be settled in accordance with the rules of the American Arbitration Association. The arbitrator may award all costs of dispute resolution, including attorneys' fees, to the prevailing party. Seller agrees that the Product to be furnished under this Order was produced in compliance with all applicable federal requirements with respect to fair labor standards and equal employment opportunity.

7. **LIMITED WARRANTY ON PRODUCT.** Seller warrants that all Products are warranted to be free of defects in material and workmanship for a period of two (2) years from the date of shipment. This excludes glasses.

Eyewear shipments in the U.S. are covered by a 30-day warranty from date of shipment. Products returned under the above warranty shall be either repaired or replaced at the sole discretion of INFAB, LLC., and is limited to the value of the Products on the date of the original shipment. All replaced parts and Product become the property of Seller. This limited warranty does not include service to repair damage to the Product resulting from customer's negligence, misuse, modification of the Product, or use for purposed other than those intended by its manufacture. Does not cover excessive use or wear and tear from improper storage or customer abuse or failure to follow proper care guidelines. Warranty is voided if any solvent based cleaning solutions are used. Seller's obligations under this limited warranty are conditioned upon Customer's compliance with Seller's reasonable instructions and requests in connection with its performance of such obligations. Service under this limited warranty may be obtained by delivering the Product at Customer's expense (using the original shipping container or its equivalent) during the warranty period to the manufacturer and providing proof of purchase date. Customer shall assume the risk of loss or damage in transit. Seller shall bear the cost for return of repaired or replaced Product under valid warranty claims to Customer by normal commercial means in the continental United States. For further information, refer to the Limited Warranty contained in Seller's standard product literature, if applicable.

NOTE: All aprons must be inspected by the facility before they are put into service. No returns for aprons with alleged pinholes, tears, or cracks will be allowed more than seven (7) days after the aprons have been received by the end user. Protective core material is fragile, easily damaged and therefore great care is needed to protect the integrity of the core material. All aprons are inspected and free of defects when they are shipped. Pinholes, tears, cracks and other damage to the protective core material can be caused by many different factors, but if they are not there when the apron is received and inspected, then they are not the responsibility of the manufacturer and the warranty does not apply.

EXCEPT AS SET FORTH HEREIN AND IN THE LIMITED WARRANTY INCLUDED IN SELLER'S STANDARD PRODUCT LITERATURE, IF APPLICABLE, SELLER HEREBY DISCLAIMS ALL OTHER WARRANTIES, EXPRESS OR IMPLIED, ARISING OUT OF OR IN CONNECTION WITH THE SALE OR USE OF THE EQUIPMENT, INCLUDING, BUT NOT LIMITED TO, THE IMPLIED WARRANTIES OF MERCHANTABILITY AND FITNESS FOR A PARTICULAR PURPOSE. OTHER THAN AS STATED ABOVE THE LIMITED WARRANTY SET FORTH IN THIS SECTION, COMBINED WITH THE LIMITED WARRANTIES CONTAINED IN SELLER'S STANDARD PRODUCT LITERATURE, IF APPLICABLE, SHALL CONSTITUTE THE SOLE AND EXCLUSIVE REMEDY OF CUSTOMER AND SHALL ESTABLISH

THE SOLE AND EXCLUSIVE LIABILITY OF SELLER, ITS SUCCESSORS OR ASSIGNS IN CONNECTION WITH THE PRODUCT. IN NO EVENT WILL SELLER BE LIABLE TO CUSTOMER FOR ANY DAMAGES, INCLUDING SPECIAL, INCIDENTAL OR CONSEQUENTIAL DAMAGES, ARISING OUT OF THE USE OR INABILITY TO USE SUCH PRODUCT, EVEN IF SELLER HAS BEEN ADVISED OF THE POSSIBILITY OF SUCH DAMAGES, OR ANY CLAIM BY ANY OTHER PARTY. SOME STATES DO NOT ALLOW THE LIMITATION OR EXCLUSION OF IMPLIED WARRANTIES OR OF LIABILITY FOR SPECIAL OR CONSEQUENTIAL DAMAGES, SO THE ABOVE LIMITATION OR EXCLUSION MAY NOT APPLY TO YOU. SOME STATES DO NOT ALLOW THE LIMITATION OF LIABILITY OR THE EXCLUSION OF IMPLIED WARRANTIES, SO THE ABOVE LIMITATIONS AND EXCLUSIONS MAY NOT APPLY AND CUSTOMER MAY ALSO HAVE OTHER RIGHTS WHICH VARY FROM STATE TO STATE.

8. **DAMAGE IN SHIPMENT.** The packaging of Infab products meets or exceeds all requirements of the Consolidated Freight Classifications. However, all packages should be checked immediately upon arrival at Customer's facility. Should any concealed damage be suspected the Customer shall note it on the Bill of Lading when received. If any concealed damage is discovered, place a hold the shipping container and contact the carrier to schedule an inspection. Any claim must be made directly to the carrier within 24 to 48 hours of merchandise or the claim may not be allowed. Any claim for damage must be made directly with the carrier. Infab cannot file a claim in the name of or for the benefit of the Customer. Failure to follow this exact procedure could invalidate your claim.

9. **DELIVERY.** All stock items are shipped from our warehouse the same day if P.O. is received before noon. Otherwise it will ship next day. Non-stock or custom items (such as modified or special size aprons and/or monogramming) are shipped within 7 to 10 days of our receipt of your completed order. All special services such as UPS Blue or Red, Fed-Ex, Airborne, etc. can be accommodated at actual cost.

10. **MINIMUM ORDERS.** There is a \$100.00 minimum per purchase order.

11. **EXCHANGES OR RETURNS.** Exchanges or Returns must have prior approval by notifying us within 5 days of receipt of the order whether shipped direct to you or drop shipped to your customer. All returns must be sent in their original packaging. A 20% restock charge plus all freight charges including the outbound and return freight will be due and payable. Custom items such as special sized aprons, monogrammed aprons or a product with any modification are not returnable. This includes barriers or racks in any other color except our standard Medical White.

INFAB

INFAB, LLC.

Email: info@infabcorp.com

www.INFABCORP.com

1040 Avenida Acaso

Camarillo, CA, USA 93012

Phone: (805) 987-5255

Fax: (805) 482-8424



REV003 230112